

SAM LOYD'S
CYCLOPEDIA
OF
5000
PUZZLES
TRICKS
AND
CONUNDRUMS
WITH ANSWERS

CYCLOPEDIA OF PUZZLES

CYCLOPEDIA

OF

PUZZLES

BY

SAM LOYD

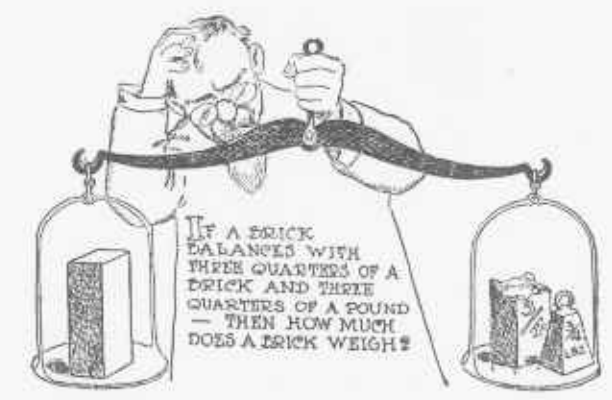

NEW YORK
THE LAMB PUBLISHING COMPANY

COPYRIGHT, 1914, BY
SAM LOYD

PREFACE

The Cyclopedia of Puzzles presents to that legion of people, young and old, who delight in puzzle-solving, a comprehensive collection of puzzles garnered during many years of pleasant labor in the fields of Puzzledom. All the best of modern puzzle creations, as well as those of ancient origin, together with their solutions, are gathered in the Cyclopedia.

Almost every page may be regarded as a little family puzzle department in itself, containing as it does a variety of puzzles, simple and difficult, mathematical and otherwise. A lover of puzzles browsing through the pages, whether he be the veteran solver or the youngster who is just beginning to agitate his grey matter with riddles and word puzzles, will find abundance to feed upon.

Puzzling is a pastime of very ancient growth, rich in historical associations, and embracing much that is romantic, as well as scientific. The Cyclopedia abounds in those classical tidbits which, collectively, give us as true a history of the art and literature of puzzledom as may be written.

I have always treated and considered puzzles from an educational standpoint, for the reason that they constitute a species of mental gymnastics which sharpen the wits and train the mind to reason along straight lines. As a school for cleverness and ingenuity designed to make of study a recreation, and as an aid to both scholar and teacher, I dedicate this work to the school-children of America.

NOTES

The Cyclopedia of Puzzles contains over 5,000 puzzles, tricks, conundrums, riddles, etc., of which about 1,000 are illustrated.

Solutions to the puzzles are printed in the last pages—from page 340 to page 384 in consecutive order. To find the solution of a puzzle turn to the solution pages, and note at the top the numbers of the puzzle pages to which they apply. It will then be a simple matter to locate the sought-after solution. For example: The first solution page, 340, as noted at its top, contains answers to puzzles appearing on pages 7, 8, 9, 10, 11, 12, 13 and 14. Many of the charades and word puzzles throughout the book are accompanied by their solutions expressed in simple numerical cipher; that is, the letters of the alphabet are represented by numbers in corresponding order. For instance, the word "CYCLOPEDIA" would be expressed by 3, 25, 3, 12, 15, 16, 5, 4, 9, 1.

Such puzzles as are accompanied by their answers are not duplicated in the solution pages.

A PRIZE OFFER

A number of puzzles in the book have been selected as "Prize Puzzles," so of course their solutions are withheld.

A prize of one hundred (\$100) dollars will be awarded to the person who sends in the best set of correct answers to these "Prize Puzzles" before the first of January, 1915.

A feature of the contest lies in the fact that each solver must in the first place discover the "Prize Puzzles," which can be identified through the absence of their solutions, so do not write and ask which they are. That is for you to find out.

As the reader proceeds through the book he should make notes of such puzzles as he discovers have no given solutions. If complete, that will be the list of "Prize Puzzles."

There are no conditions attached to this prize offer other than that a contestant's solutions must be sent collectively—the answers to the complete set of "Prize Puzzles" forwarded in one envelope, and posted not earlier than December 1, 1915, and not later than January 1, 1915, addressed to SAM LOYD, New York Press Club, New York City.

If you do not succeed in securing answers to all of the "Prize Puzzles," nevertheless be sure to send in your best efforts, for a number of complimentary prizes will be awarded among those who rank highest in the contest.

The first prize of \$100 will go to the author of the best received. Best means best from every possible standpoint, correctness, method of expression, etc.

Mr. Loyd will personally superintend examination of all answers.

To be eligible to enter this contest it is not necessary to own outright a copy of the Cyclopedia of Puzzles. Several members of a family may send in their individual papers while working from the same volume.

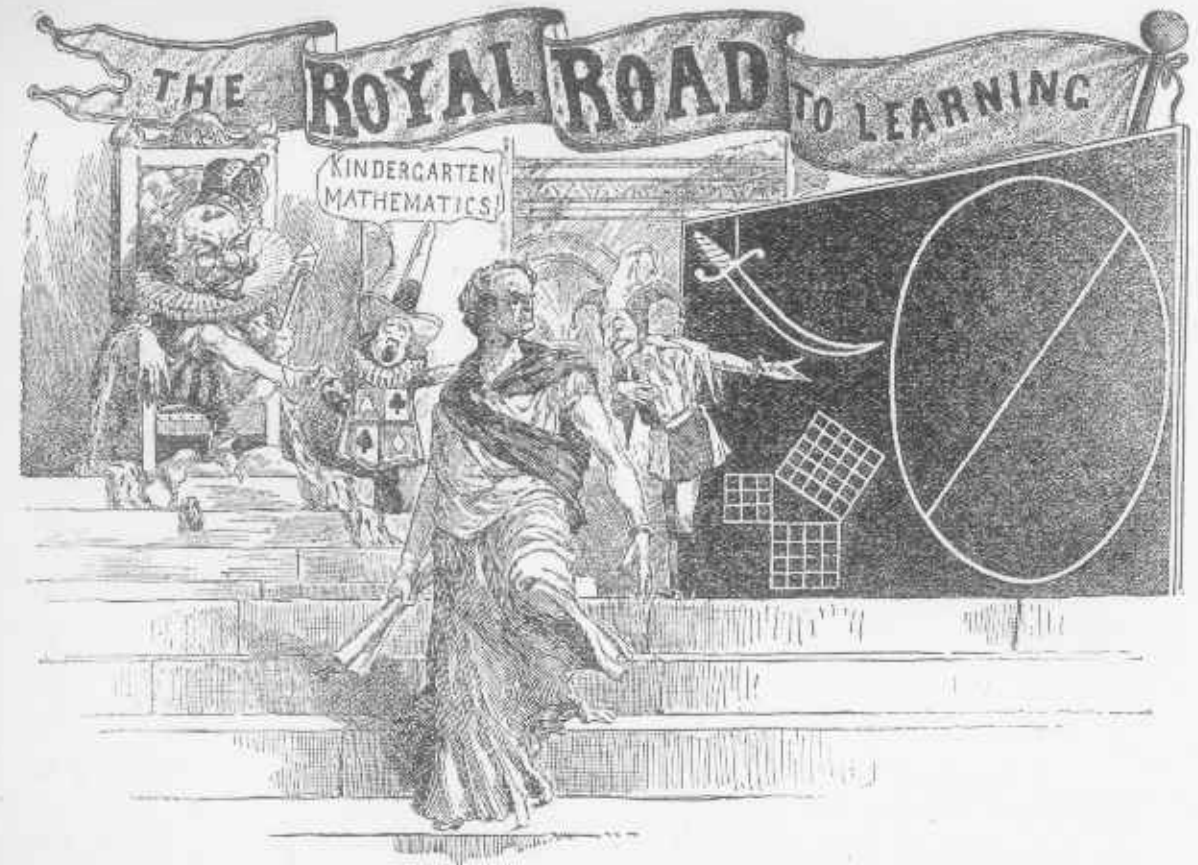

HISTORY TELLS HOW Euclid, the Greek mathematician and philosopher, who flourished 300 years B. C., while expounding the problem of subdividing the circle to King Ptolemy, was interrupted by the irate monarch exclaiming: "I am wearied by such dull lessons, and refuse to burden my memory with stupid rules!" Whereupon the great mathematician replied: "Then your majesty will graciously permit me to resign the position of Imperial instructor, for none but a fool knows of a Royal Road to Mathematics."

"Right you are, Eucl!" interjected Beppo, the court jester, as he pushed his way to the blackboard," and, in accepting the position so gracefully tendered, I will proceed to demonstrate how the great principles of higher mathematics can be taught by simple kindergarten methods which children may understand and remember."

"Philosophers say:" 'what is learned with pleasure is never forgotten, but knowledge can not be beaten into the head with a worm-wood club.' "Pupils should not be made to commit rules to memory;

everything should be explained so that they can formulate rules in their own language. A pedagogue who teaches rules would be a good one to train parrots!"

"Dry mathematical problems are more digestible when presented in palatable form, and the mind becomes stored with valuable information when the illustrations are gleaned from the classical tid-bits of history."

"Mathematics, which constitutes the most important branch of learning, forms the groundwork of the arts and sciences, and is so essential to the successful man of affairs, as well as the development of a clear brain, that parents should realize the advantage of encouraging an early love for puzzles, tricks and problems among their children."

"With the kind permission of your majesty," continued Beppo, "we will now elucidate the subdivision of the circle by asking Tommy Riddles, the court crier, whose learning is limited to the science of simple addition, to show into how many pieces it is possible to divide a German Pancake with seven straight cuts of a knife?"

"Furthermore, to add a point to the moral of the story of the sword of Damocles, which is shown to be suspended over our heads by a single thread, we will proceed to impress it indelibly upon the memory by connecting it with a scientific and practical problem: Why is the blade of that scimeter always shown to be curved?"

"Noting with pleasure the presence of the 'Pons asinorum,' the ass's bridge problem, which my distinguished predecessor has made famous as his 47th proposition, which proves that the square described on the long side of a right-angled triangle, termed the hypotenuse, is equal to the sum of the squares of the other two sides, I will ask the author of the 47th proposition to tell how many rails of equal length it would require to enclose a right-angled triangular field if one of the three sides was 47 rails long?"

"The clown's 47th proposition" will doubtless prove that many good mathematicians have much yet to learn regarding the wonderful principles of Pons asinorum which may be said to underlie the foundations of mathematics and geometry.

NOTE.—"Pons asinorum" originally applied to 5th proposition—First Book of Euclid—that "The angles at the base of an isosceles triangle are equal to one another."



Proposition: Can you mark off exactly 50 points

My chum and I were taking in the side shows the other day, when we struck what the man told us was the squarest game in the world. There were ten little dummies which you were to knock over with base balls. The man said take as many throws as you like at a cent a piece and stand as close as you please. Add up the numbers on all the men that you knock out and when the sum amounts to exactly 50, neither more nor less, you get a genuine Maggie Cline cigar with a gold band, worth a quarter.

Our money gave out before we learned how to win, and we noticed that lots of people didn't smoke any more Maggie Cline's than we did. The man who run the business said he didn't mind telling us that people let their prejudices ruin their

chances. An Irishman would always soak the coon, while the darkies had it in for that Chinaman, and as a matter of fact every one had their race prejudices which kept them from winning.

Can you show how we might have made exactly 50 points, and won a Maggie Cline cigar with a gold band around it?

Puzzle of the Iceman

Every blank is to be filled with a word ending in i-c-e.

At the time of the summer —, the iceman, whom no one should accuse of — or —, put up a — at an — in his —, put the effect that with — toward none he would give good — to all, without — or —.

Accordingly, he supplied the politician with —, the lawyer with —, the doctor with a —, the judge with —, the builder with a — and a —, the gambler and his — in their den of — with —, the bridal party with —, the clergyman with a —, the cat with —, the drinker with —, the geologist with —, the woodman with a —, the sailor with a —, the dentist with a —, the dressmaker with a —, and no one with the —.

But in spite of all his efforts to supply ice to —, some people objected so strongly to his —, that they applied to the — for — regarding a —, by which they might either push him into a — or over a —!

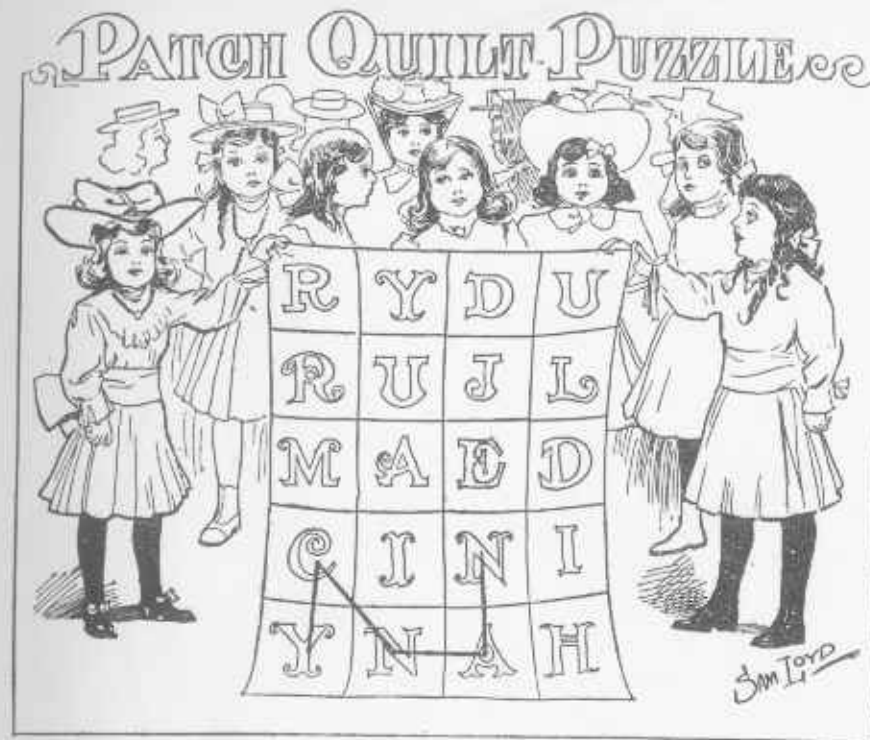

The children have worked all of their names into a wonderful patch-quilt puzzle, which they are going to present to their teacher. Commence wherever you please and go from square to square, and see how many names you can discover. Beginning at N, for example, as shown by the lines, you can spell NANCY, but when you find all of the others you will know just how many scholars went to this school in Puzzle-land.

that part of his letter which described this picture:

"P. S.—I want to say that the first thing I did after getting here was to go to the barnyard, and I found that the story that horses and cows never lie down to sleep is a fake. I send you a picture I made of them as they were lying in the barnyard. I watched them a long time, and they never moved, except the cow, which had a piece of chewing gum in her mouth, and to be certain that the horse wasn't dead I hollered 'Shoo!' And you ought to see them scramble to their feet."

Sammy's Sketch-Book



If you can only draw a little bit you might find lots of things worth showing. Sammy spent a few days on the farm and filled his sketch-book full of interesting things. Here is what he calls "pastoral still life." The second view represents "a moving picture" of the same scene, showing the animals getting up on their feet. As an elementary drawing lesson, you are invited to sketch the moving scene as it appeared to Sammy. Upon second thought I give

P. S.—Do you remember how Houdin, the famous magician, used to exercise his memory by glancing in a store-window and then telling how many things he could recall having seen during a one minute's inspection. He said most people went through the world without noticing anything. Did you notice the moon in my picture? It tipped the wrong way! The moon always tilts to the left. I drew that moon to make fun of Nelly; she wrote a poem and spoke about "the fleecy clouds behind the moon." Who ever heard of clouds behind the moon! The moon is always behind the clouds, but I drew it to make her mad.

P. S.—I sketched some hop vines

and what they call pole beans, but do you know how to tell which are the hop vines? Hop vines always twine round to the left, while the others twist round to the right. You learn lots of things in the country.

P. S.—The Smith boy was down here Sunday, I asked him how many eggs he thought a peacock laid. He counted a brood of little ones and said "ten." I then told him that peacocks don't lay eggs. A peacock is a gentleman peacock, the peahens lay eggs. "You might just as well ask how many eggs does a rooster lay?" But Smithy is a city chump and don't know lots of things.

P. S.—Do you see that chicken looking at the dog? how do I know its a dog? because a cat can't have a white tip to her tail. If a cat has any black on her at all, the tip of her tail is black, while if a dog has any white anywhere, the tip of his tail will be white. You never saw a chicken meandering by moonlight in your life, nor did you ever see a hen with spurs! Did you think of that?

P. S.—I drew this picture to see if you can illustrate the difference between a horse or a cow getting up; but talking about that chicken, can you tell why it is like a farmer? Can you tell that it is a large chicken? What parts of an army do you see? Why does it remind you of the gas man? What parts of a mountain do you see? What part of a kite? What part of a will? What part of a needle? What should it lay on the dressing table? What else does that chicken show that is interesting? Show the source of a river, three nicknames, something on a canal, and part of a table.

P. S.—I won't wait to see how you draw the horse and cow getting on to their feet, because I guess a person has to live in the country to learn that a horse always raises bow end up first, while a cow gets up stern end first. The first horse and cow must have begun to get up that way, oh an awful long time ago, and all other little horses and cows did the same as their parents.



PUZZLE OF



Here is another Rail Road Puzzle, which illustrates a pretty mathematical principle and at the same time points a moral and adorns a tale which all might ponder over to advantage:

"I am satisfied that some cows have more sense than the average man," soliloquized Casey, in his philosophical way. "My old brindle was standing on the long bridge the other day, placidly looking into the water, when she spied the lightning express, just twice the length of the bridge away from the end, coming at a ninety-mile an hour clip. Now, she did not waste the forty-eleven-millionth part of a second in idle speculation; she just made a dash towards the advancing train and saved herself by the narrow margin of one foot, whereas, if she had followed the human instinct of running away from the train, three inches of her rear would have been caught on the bridge!"

"It would be a great thing if some procrastinators, who never can make up their minds one way or the other, were placed in the position of my old brindle cow, so they had to think quick!"

"It is a pretty problem to reckon the gait of that cow, and to tell how far she was standing from the middle of the long bridge! Can you figure it out?"

A REBUS.

A term for scolding, backwards read, Will give what all good people dread;

A character so base, that none The epithet would call their own.
Rail—Liar.

A vessel reversed will give the highest point, and a child's toy. Pot—top.

Spell one word with the letters: To Love Ruin. (Revolution.)

Why is a watch like a river? Because it doesn't run long without winding.

A REBUS.

My first's the heart of honest trade, When 'tis judiciously displayed; But when 'tis of its head bereft, It then becomes a public theft.

Cypher Ans. 19, 16, 5, 3, 21, 12, 1, 20, 9, 15, 14.

CONCEALED GEOGRAPHY.

34. It is the belief of the ancients that heroes' souls soar to islands of the blessed.

35. He has my R. N. as a monogram on all his note-paper.

36. He brought orses to Hannah, antelopes to Carrie.

37. A Psyche in marble he adored as if alive.

38. I am her stupid sister.

39. Kate can't tell a wren cemented, from a wren demented.

40. In adjusting the baby-jumpers, I adjusted the baby, so that it fell out. (A country.)

41. The calmest man is sometimes made irate. (An island.)

42. Away they went and over the race-course spun.

43. The sale must commence at one o'clock.

44. Would you bid a cow or ox bury their dead?

45. What do you call Mr. Rarey? A horse-tamer, I call him. (A country.)

46. The only animal taken was a Kangaroo. (An island.)

47. The moment I walked I saw three crows on the bedpost.

48. After singing a "te deum," bag, O soldier, your booty. (A lake.)

49. The Ojibbeway retired and the Mosquito led on his troops.

50. They made a hue-and-cry, but ah, of no avail. (A territory.)

51. You should see Parepa Rosa cram entomological specimens into her handbox.

52. Socrates considered a warming pan a matchless affair.

53. King William wrote a letter to a hunter.

A REBUS.

Fair Bessie promised to bestow My first upon her lover, And much I hope that no dark clouds Around the pair may hover.

Sweet Bessy's age is just eighteen, Of gold she has my second; On bearing off the lovely prize How many beaux have reckoned.

And now my riddle I'll conclude, And hope you'll not me quiz, For what I say is very true— My whole fair Bessy is.
Cypher Ans. 8, 1, 14, 4, 19, 15, 13, 5.

What pudding makes the best cricketer? A good batter.

Tom went out, his dog with him; he went not before, behind, nor on one side of him, then where did he go? On the other side.

Why was Moses the most wicked man that ever lived? Because he broke all the commandments at once.

Why are crockery-ware dealers different from other merchants? Because it won't do for them to crack up their goods.

Why is a baby like wheat? Because it is first cradled, then thrashed and finally becomes the flower of the family.

On what toe does a corn never come? The mistletoe.

What is the difference between a hungry man and a glutton? One longs to eat and the other eats too long.

Where lies the path of duty? Through the Custom House.

Why should turtles be pitied? Because theirs is a hard case.

Why should young ladies set good examples? Because young men are so apt to follow them.

Why should the male sex avoid the letter A? Because it makes men mean.

Why must chimney-sweeping be a very agreeable business? Because it suits (soots) every one who tries it.

Why is a joke less durable than a church bell? Because after it has been told (toll'd) a few times it is worn out.

Why is Ireland likely to become the richest country in the world? Because its capital is always doubling (Dublin).

Why should you never tell a man to take a back seat? Because, if you do, he'll be likely to take a front.

BICYCLE TOUR PUZZLE BY SAM LOYD.

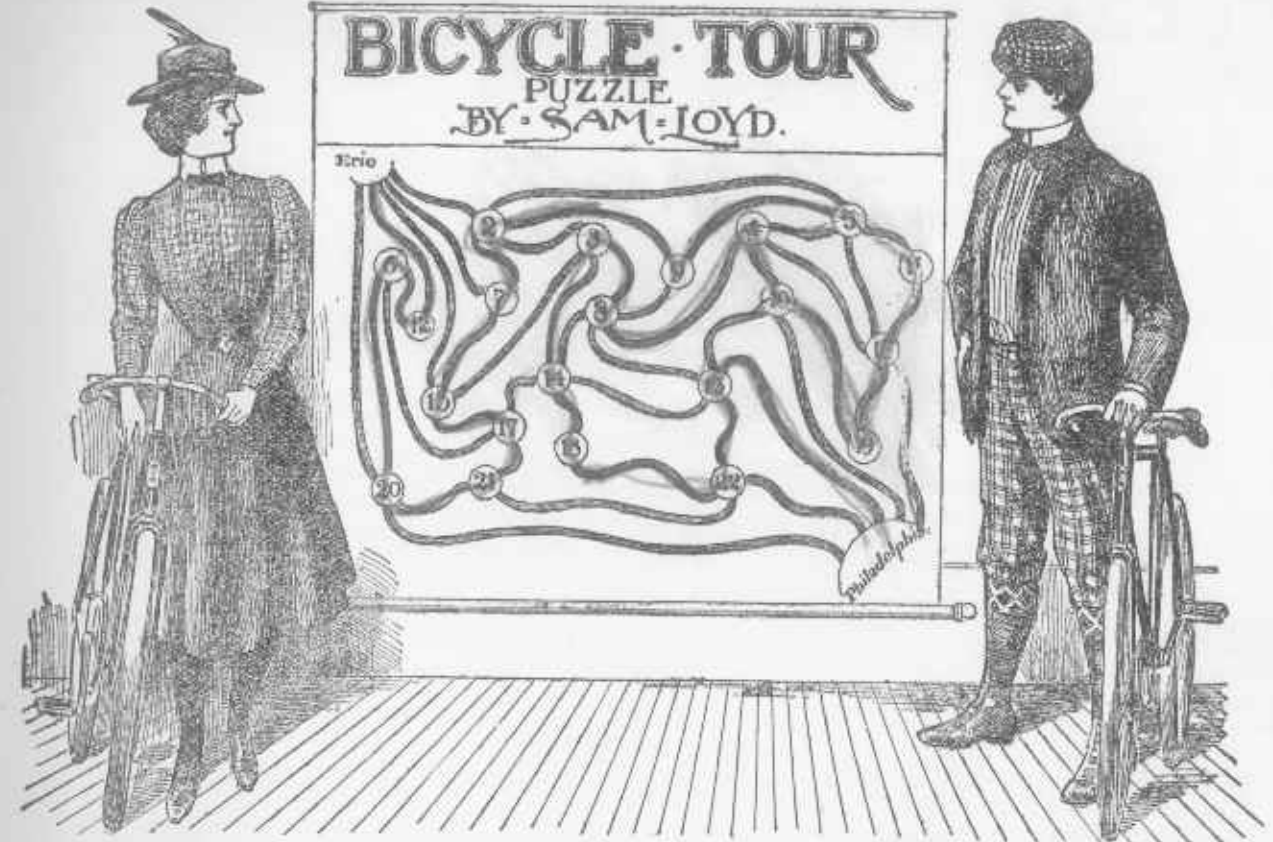

PROPOSITION—Show the route from Philadelphia to Erie, passing through all the towns but once.

HOW THAT THE L. A. W. and Good Roads Association have done so much toward bettering the bicycle paths of the country, it is being suggested by the press that something might be done to impart an artistic finish to many popular routes for the benefit of those who ride by the wheel or auto. Whether it is intended to round off the harsh corners and convert the straight lines into graceful curves, or to induce the malicious fiends who scatter tire-puncturing carpet tacks along the paths, to throw poppy and sunflower seeds instead, is not made clear, but the idea is a good one, and suggests the accompanying artistic map, with a pretty puzzle incidentally added.

The map shows twenty-three prominent cities of the State of Pennsylvania connected by bicycle routes of more or less artistic design. The problem is a very simple one: merely start on your summer outing and go from Philadelphia to Erie, passing through every one of the cities but once and without going over any road twice. That is all there is to it. The cities are numbered so as to enable solvers to describe their routes by a sequence of

figures. In this trip the usual practice of getting there by the "shortest route possible, etc.," will be dispensed with. Just get there without minding the cyclometer, and get an answer by giving the sequence of towns passed through.

A Bicycle Mishap.

Here is another pretty bicycle puzzle which confronted Fred and his best girl on that same circuitous cross state tour which was to culminate at Erie. They had gone some distance when Fred's sprocket wheel broke off in such a way that temporary repairs were out of the question, and they were so remote from any hope of other assistance that it was deemed to be a mere question of reaching home in the shortest possible time. The young lady could be depended upon to maintain a five-minute clip to the finish. Fred was an expert rider who could keep up a three-minute speed when riding upon his own wheel—but if he rode her wheel it reduced his speed to three and a half minutes.

It was evident when the accident occurred that some walking must be done. She could walk a mile in twenty minutes, handicapped by leading a wheel. He could walk a

mile in fifteen minutes encumbered with the broken wheel.

An extra sprocket wheel was at home and could be attached in ten minutes, so assuming they left home at 10 A. M. and returned at precisely 6 P. M., the problem is to tell how far they have travelled by their cyclometers, if they had gone as far away from home as was possible in accordance with the conditions described.



PUZZLES FROM A HARDWARE SHOP



Here is a collection of pictorial rebuses representing well known articles which we see in a hardware store. This puzzle is designed for the little folks who should soon be able to originate puzzles on similar lines.

The Cashier's Problem



The bank cashier could tell some interesting experiences which occur to enliven the routine of ordinary business, and of some pretty problems of a very puzzling nature. What would you do, for instance, when an old gent, who, like the majority of mortals, is averse to figuring, pushes in a check for 200 dollars and says: "Give me some one dollar bills, ten times as many twos, and the balance in fives!" I say, what would you do?

A Charade.

A word, I know, will quickly show
What wicked people are;
And when transposed, will be disclosed

A name they always share;
Transposed aright, 'twill bring to light,

What all would wish to do,
If altered now, 'twill fairly show
What hides them from our view.
Cipher Answer.—5, 12, 9, 12.

"A Horse's Head Where His Tail Ought To Be."



Among the curious things which Mother Goose tells the young folks they will see in Wonderland, nothing in the entire category of her jingling rhymes excites the juvenile mind

more than the description of the monstrosity of the "Horse with his head where the tail should be." The very suggestion is so inconceivably funny and gives such scope for flights of imagination that it will be a grand puzzle to discover who can make the best transformation, according to the well-known lines:

See! see! what shall I see?
A horse's head where his tail should be.

We reverse the order of things in this puzzle, and will put the cart before the horse so as to give the answer showing the horse's head where his tail ought to be; now exercise your artistic ability and make a sketch showing the simplest way to transform the picture and place things where they belong.

An Illustrated Proverb.



Here is a pictorial proverb, given to sharpen the wits of the little ones. Puzzles of this kind form the stepping stones to problems of greater difficulty.

A Rebus

Short was my life, and brilliant my career;
Behold me, I in lovely green appear;
Behold again, I once was made to save

My chosen inmates from a watery grave.
Cipher Answer.—19, 16, 1, 18, 11.

A Conundrum

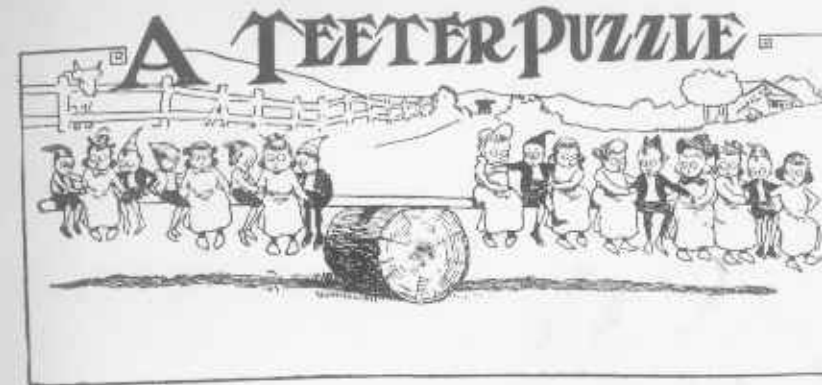

Elementary Lessons in Algebra

If all of those little boys were seated on one arm of the see saw, how many girls would it require on the other end to keep the balance even?

A teeter tater illustration gives a clearer idea of the algebraic meaning of the two sides of an equation than could be acquired from months of hard study. Let us illustrate the first principle of algebra which tells us that like quantities added or subtracted from both sides of the balance do not change the equilibrium. We will solve the puzzle by the principle of cancellation. There are five boys on one arm of the balance and three on the other, so we cancel off three from each end. Then as there are three girls on one end and six on the other, we will cancel off three from both sides so as to leave two boys balancing with three girls. Startling as it may look, we find that two of those little boys weigh the same as three girls, so if the eight little boys were placed on one arm of the see-saw it would require twelve of the fat girls to balance them! You see to make the picture deceptive the little boys were filled with lead.

Why is a game of tennis like a party of children? There is always a racket.

What sweetmeat is like a person proposed for some office? The candied date (candidate).

Why is a sick Hebrew like an emerald?
Because he is a Jew ill.

Why is the printer like the postman?
Because he distributes letters.

What is the difference between a sun-bonnet and a Sunday bonnet?
A day's difference.

A Charade

My first, gentle lady, you give to the youth

Who now breathes the fond wish of his soul;
Whom with ardent affection, and honor and truth,
You perceive is needed in my whole.

In my snug little second, secure from the storm,

We the helpless and innocent find;
And my whole, when a contract or bargain you form,
You should give, the agreement to bind.

Cipher Answer.—5, 1, 18, 14, 5, 19, 20.

A Puzzle.

Express with four letters a sentence of four words containing four letters.

Answer.—I O U O.

Why are unprotected grates like insolent beggars?
Because they are destitute of fenders.

A Charade

Perhaps you may know
That centuries ago
My name the world was unknown;
But now 'tis allow'd
In the midst of a crowd
I am met with in every town

Though varied each lot,
In life I have got,
Yet nothing my course e'er endangers;
And wherever I go
So familiar I grow
That I am nodded to even by strangers.

I am cunning and bold,
For young or for old
I fear not, but bawl out aloud;
Pugnacious, you'll say,
For I knock down by scores in a crowd.

I lie and mislead,
So I pray you take heed;
My art's like a point of a thistle;
Be nice in your choice,
Take Franklin's advice,
And don't pay too much for your whistle.

Cipher Answer.—1, 21, 3, 20, 9, 15, 14, 5, 5, 18.

A Rebus

In every hedge my second is,
As well on every tree.
And when the schoolboy acts amiss,
It often is his fee.

My first, likewise, is always wicked,
Although it does no sin.

My total for my first is fitted,
Is made of brass or tin.

Cipher Answer.—3, 1, 14, 4, 12, 5, 19, 20, 9, 3, 11.

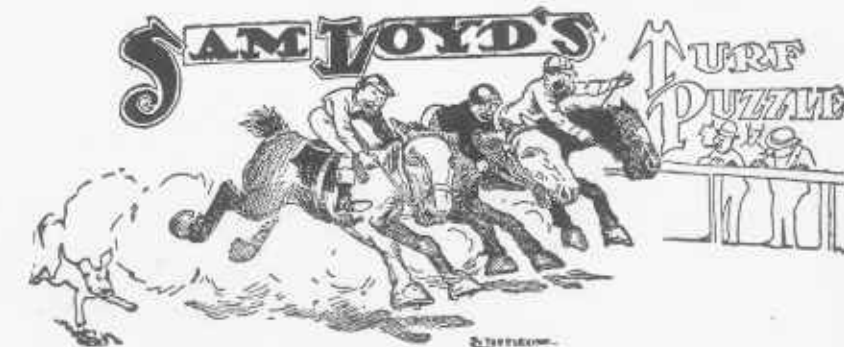

To show how little the patrons of the turf know about the theory of odds as practiced at the race track, let readers seek a solution to the following elementary problem: If the odds are 7 to 3 against Apple Pie and 6 to 5 against Bumble Bee, what should be the odds against the famous running horse Cucumber?

A SWISS PUZZLE



THERE is a very pretty trick performed by Miss Carré Schwitzer, which rivals Betsy Ross' feat of producing a five pointed star with one clip of the scissors. When Admiral Schwitzer asked his daughter to suggest an ensign for the Swiss navy, Carré seized an odd shaped remnant of red wall paper and skillfully divided it in two pieces which would fit together so as to form the Swiss flag with the white cross, as shown in her left hand. When she was told of Betsy Ross' feat she said she could go her one better. She took a Swiss flag, as here shown, and cut it in two pieces which would fit together and form a perfect square.

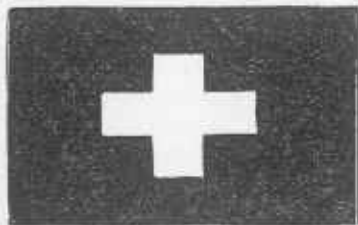

Of course if you can make a Swiss flag from a square, it is just as easy to reverse the operation—cut a square in two pieces which will form the flag.

Carré performed other feats with the Swiss flag which we will take occasion to mention. When she had charge of the signal station on Mt.

Pilatus and wished to signal the fleet that a storm was rolling down the mountain, she took a square piece of bunting and cut it into two pieces which would fit together and form the following flag.



In the Swiss language this tells of an approaching storm. Literally translated it says: "There will be a hot time in the old town to-night." Just to see how clever Miss Schwitzer was, try to cut the signal flag in two pieces which will form a perfect square.

Miss Schwitzer always acted on the square and was much respected on that account. She taught her Sunday School class how to cut three little squares into the fewest possible number of pieces so as to form one big square, and also the way to cut the three squares so as to form a Swiss cross, more recently known as the Greek cross. Try both of these puzzles.



William Tell asked her how to make a Maltese cross and she re-

plied "pull its tail." She founded the order of the red cross.

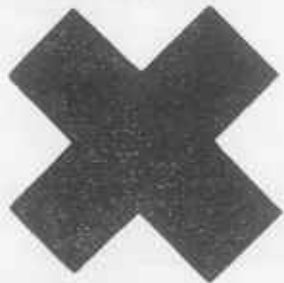

There are two very beautiful puzzles connected with this cross, which are worth knowing: Cut the cross in two pieces which will form a rectangle, or cut it in three pieces which will make a perfect square.

We shall take early occasion to mention some of the marvelous feats performed by Carré Schwitzer in cutting Swiss cheeses, and juggling with pans of milk at her Swiss milk factory, near the chalk hills of Luzerne.

A Charade

If you a journey ever take,
No matter when or where,
My first would surely have to pay
Before you can get there.
My second you would scarcely see
If London through you go;
But still 'tis what I hope you are:
Few better things I know.
I say my whole with secret pain,
Though hoping soon to meet again.
Cipher Answer.—6, 1, 18, 5, 23, 5,
12, 12.

A Rebus

To warn you of danger before you we stand,
Which we're sanctioned to do by the heads of the land.
Our counsel unasked we most gladly impart,
Some virtuous impression to make on your heart.
But if you trespass, as you surely will find,
A punishment justly for sinners designed.
Cipher Answer.—16, 18, 9, 5, 19,
20; 19, 20, 18, 9, 16, 5, 11.

A Riddle

A hundred and fifty, when joined to a tree,
Makes a fine garment that warms you and me.
Cipher Answer.—3, 12, 15, 1, 11.

THE LITERARY BURGLARS

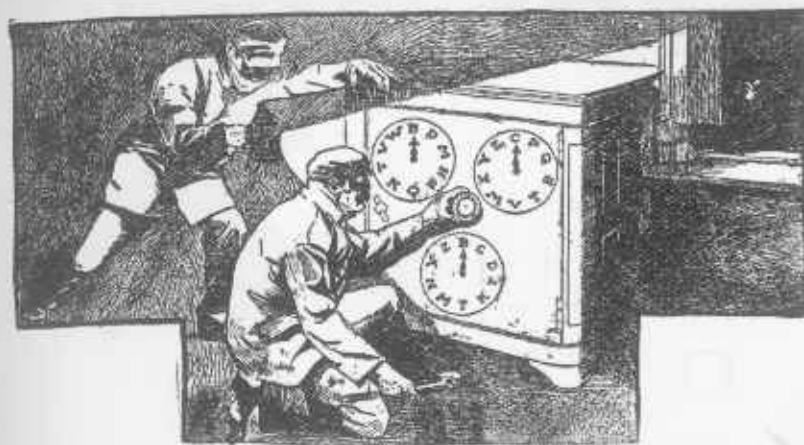

THE principle of a safe lock, of the kind most generally known as a combination lock, pertains to the nature of a puzzle pure and simple, and, indeed, such locks are referred to by the oldest writers on the subject as puzzle-locks. A combination lock is nothing but a puzzle, and its safety depends entirely upon the difficulty, or rather the improbability of a person guessing the right combination.

Here are two literary burglars bent on opening a safe by guessing the three letter word which serves as the key. You can see that there are but ten letters on each dial, so you can open the safe by finding a three-letter dictionary word, one letter of which is shown on each dial.

As comparatively few persons understand anything about the principle of a safe lock, it will be of general interest to give a simple explanation of the inside workings:

Look at the construction of the first combination lock ever made; and despite of the thousands of patents and great improvements made of late years, the principle is always the same. I have taken out numerous patents on improvements to make them safer, but bankers and others who have large sums of money locked up in their safes would feel more apprehension if they understood the real nature of a combination lock. It might baffle a burglar for a month, but is just as likely to be opened in from one to twenty minutes. On several occasions when I was called in to open a safe lock the trick did not require fifteen minutes.

During the Paris Exhibition of

1867 I was so lucky as to open three French safe locks in less than half an hour, but then at that time the French locks were absolutely worthless.

Let us take an inside view of that lock the burglars are working on.



Each outside dial connects with a round disk or tumbler with a slot which must be placed in position to receive that crooked hook which we call the dog. You cannot turn the middle handle which draws the bolt until all three of the disks are in their proper position at the same time, and you can only tell when they are in their correct position by knowing the proper letters to which the lock is set. If there are only ten letters on each dial and there are but three tumblers, the burglar will probably open the safe in fifteen minutes, for 10 x 10 x 10 gives but 1,000 possible changes, so the chances are he will hit it in 500 trials.

I give this primitive illustration of a three tumbler lock, because it is the same that A. C. Hobbs, the fa-

mous American expert, brought to me somewhere about 1851, when he picked the great Brahmah lock in London and won two hundred guineas.

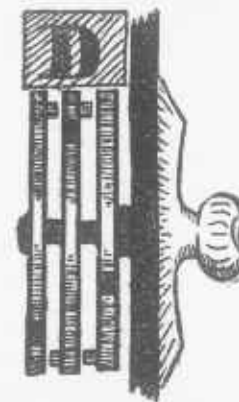

The tumblers are placed upon one pin now, which is a great improvement. The dog (marked D) falls from its own weight into the niches when they are placed in proper position. You can only turn the one handle, placing the tumblers in position one at a time. Turning three times forward, twice backwards and then one forward again.

The tumblers of the ordinary key locks are guarded much in the same way:

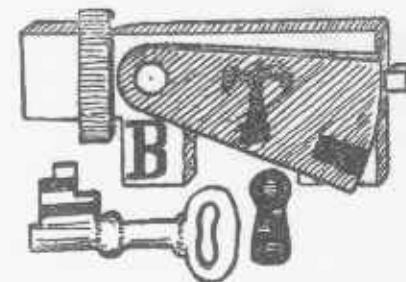

In the above illustration the bolt is kept from being drawn back to the right by the tumblers marked T. They turn on the round pin and press against that little square dog. The key therefor at the same time that it pushes the bolt back must have stop or wards which will raise the tumblers exactly to the correct height to receive that square pin in the slots.

A Riddle

I with a pen my first display;
My next increases day by day.
My whole is fraught with anxious fears
For those who'd hope for many years.
Cipher Answer.—4, 15, 20, 1, 7, 5.

GRANDFATHER'S PROBLEM

— BY —
SAM LOYD.



PROPOSITION—What is the difference in weight of six dozen dozen pounds of feathers and half a dozen dozen pounds of gold?

THERE IS ONE OF THE old-time problems of our great - grand - daddies which has been passed down through successive generations without any one's having the temerity to question the correctness of the accepted answer which is that "a pound is a pound the world over." It recently so happened, however, that a little boy from Boston, who was a juvenile puzzlist, had the antique gem sprung upon him and gave an answer which took the wind out of the sails of his dotting old grandfather.

Of course, you have asked and

been asked so often regarding the difference between six doz. pounds of feathers and half a dozen pounds of gold, that the answer comes spontaneously without a moment's hesitation, and yet, if the question is asked with all seriousness, with prizes for the best explanations just to encourage correct work, it is safe to say that it will be discovered that no one has really attempted to prove the old problem since its first appearance in 1614.

Now what is the difference in weight between six dozen dozen pounds of feathers and half a dozen dozen pounds of gold?

Now, in this particular case, I searched through the musty corners of my brain to select a few antique illustrations, with a rich chestnutty flavor, to revive, or rather arouse that interest which one of those good old familiar puzzles never fails to elicit and which are often associated with pleasant memories of the long ago. My object, however, was also to show that by giving a new set of teeth to some of these old saws, to prove that their sharpness has been overlooked by many of our puzzlists, in this as well as in other instances which will be mentioned.

SPEAKING ABOUT MY my first, and as a matter of fact most successful puzzle, I wish to say that it was originated nearly half a century ago under the following circumstances: I was returning from Europe many years ago in company with Andrew G. Curtin, the famous war Governor of Pennsylvania, who was returning from his post in Russia as a prospective Presidential candidate. We were walking the deck of the steamer, discoursing on the curious White Horse monument on Uppington Hill Berkshire England. If you know nothing about that weird relic of the early Saxons the accompanying sketch will afford an excellent idea of its appearance.



It represents the figure of a colossal white horse, several hundred feet long, engraved on the side of the mountain, about a thousand feet above the level of the sea, so that it can be clearly distinguished at a distance of some fifteen miles. It is more than a thousand years old, and is supposed to have been carved there by the soldiers of Ethelred and Alfred after their victory over the Danes, as a white horse was the emblem of the Saxons.

It looks like a patch of snow on the side of the mountain, but it is in reality produced by the green turf being removed so as to show the white chalk beneath in the form of a horse.

I am thus prolix in the description of this piece of ancient history, because it is but fair that Ethelred and Alfred should receive their share of the anathemas generally hurled at the inventor of the Pony Puzzle by those who see the answer.

After the white horse had been thoroughly discussed, the governor banteringly exclaimed:

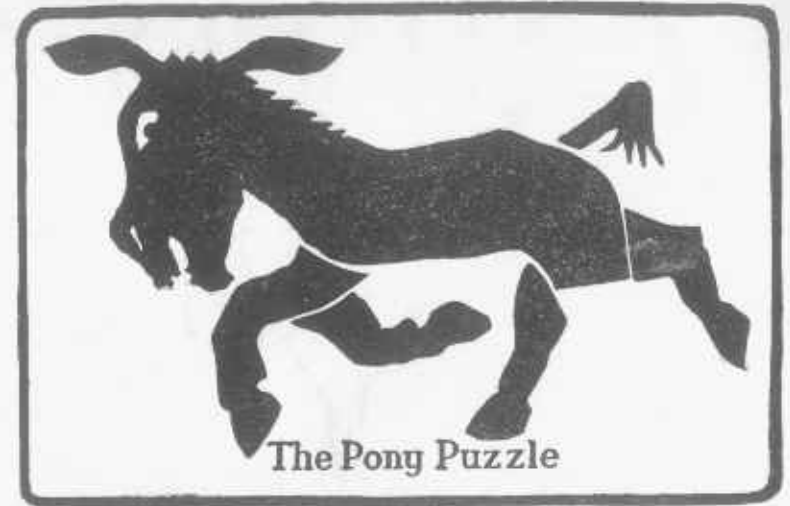

The Pony Puzzle

"Now, Loyd, there would be a capital subject for a puzzle."

Many a good puzzle idea has come from just such a tip; so, with such a capital theme, I should have been supremely stupid if I had not evolved something in response to the challenge. So, with my scissors and a piece of silhouette paper, I speedily improvised the accompanying figure of a horse, which we christened "The Pony Puzzle."

It would be a simple matter to improve the parts and general form of the old horse, and I really did modify it in the version which I afterward published, but somehow I love the old nag best as first devised, with all its faults, so I now present it as it actually occurred to me.

The world has been moving rapidly during the last decade, and puzzlers are much sharper than they used to be. In those days very few, probably not one out of a thousand, actually mastered the puzzle, so it will be a capital test of the acumen of the past compared with that of the present generation, to see how many of our clever wits of to-day can solve it.

Trace an exact copy of the figure, as shown, and cut out the six pieces very carefully, and then try to arrange them together so as to make the best possible figure of a horse. That is all there is to it, but the entire world laughed for a year over the many grotesque representations of a horse which can be made with those six pieces.

I sold over one thousand millions of "The Pony Puzzle," which reminds me to say that, whereas I have brought out many puzzles, and patented numerous inventions of more or less importance, and de-

voted much time and money, to my sorrow, upon the "big things." More money is made from little things like "The Pony Puzzle," which do not require a five-dollar bill to promote and to place on the market.

The garrulity of old age has led me into saying so much about the pedigree of this old nag that I will have to carry over to another time some remarks of practical utility which I desire to offer to such as are ambitious to present their puzzles or other inventions to the public.

Why are washerwomen great travelers? Because they are continually crossing the line and running from pole to pole.

What is the largest room in the world? The room for improvement.

Why is a street car like the heart of a coquette? Because there is always room for one more to be taken in.

When may a man be said to breakfast before he gets up? When he takes a roll in bed.

Why are teeth like verbs? Because they are regular, irregular, and defective.

What is it that a gentleman has not, never can have, and yet can give to a lady? A husband.

Why is a man just imprisoned like a boat full of water? Because he requires bailing out.

When does a ship tell a falsehood? When she lies at the wharf.

What is the difference between a mother and a barber? The latter has razors to shave and the former has shavers to raise.

Why are fowls the most economical things a farmer can keep? Because for every grain they give a peck.

THE MYSTERY OF THE BOARDING HOUSE PIE



PROPOSITION—Into how many pieces, of various sizes, is it possible to divide a pie with six straight cuts of a knife?

AS SHOWING HOW mathematics may be discussed in a digestible form, let us look into the following unique problem, which comes in with the new regime introduced by the recently formed Pie Trust:

It having come to the knowledge of the Boarders' Protective Union that the chef of Madame O'Flaharity's Pension Francais was cutting too many pieces out of one pie, which conflicts with Article V. of the by-laws, which says: "A union pie must be divided with six straight cuts of a knife," the walking delegates of the association ordered a strike among the boarders until the grievance was corrected.

The sketch shows the madame explaining the limit of possibilities in dividing a No. 6 union pie, which problem will appeal directly to the hearts of the American pie-loving people irrespective of the beauty and importance of the proposition from a mathematical standpoint.

Madame O'Flaharity is discoursing upon the advantages of extending the greatest possible latitude to the practical application of the six-straight-cut-rule which affords an

opportunity of varying the size and number of pieces according to circumstances. As a matter of fact, the opportunity for dispensing pieces of pie of variable size is generally utilized to advantage by clever landladies who have mastered the problem. The star boarders, and such as pay their bills promptly, get the big pieces with plenty of nice crust, while such as are badly in arrears get frozen out, so far as pie is concerned. And what a volume of sentiment and appreciation can be expressed by the large thick piece which the hostess serves to the young doctor who is supposed to be attentive to her daughter Mary Jane!

But we are not dealing with the lessons and morals to be found between the crusts of a boarding house pie, we are giving a kindergarten illustration of Euclid's rule, which says in mathematical lingo: "Every line must intersect every other line, but no two intersections must coincide," which to the young folks not up in mathematical lore may be interpreted as meaning that "the old folks must be helped first and the children should not ask for second pieces."

Royal Road.

The following free translation of a German poem, which appeared during the last century in a Heidelberg college paper, shows the high estimation placed upon the study of puzzles in that eminent seat of learning:

Children must be busy,
Always something learning;
Toys and playthings for their secrets,
Inside-outward turning.

While the top is spinning
The scholars wonder all,
How it stands erect unaided,
Why it does not fall.

While the top is humming,
Still the wonder grows,
By what art the little spinner
Whistles as it goes.

Children learn while playing;
Joining sport with learning;
Pastimes, often more than lessons,
Into knowledge turning.

Puzzles, tricks and riddles,
Make the children clever,
Leading by the Royal road, where
Study is a pleasure.

THE CAT AND DOG RACE



PROPOSITION—Tell whether the cat or dog should win this race, and why.

MANY years ago, when Barnum's Circus was of a truth "the greatest show on earth," the famous showman got me to prepare for him a series of prize puzzles for advertising purposes, which became widely known as the Questions of the Sphynx, on account of the large prizes offered to any one who could master them.

Barnum was particularly pleased with the problem of the cat and dog race, and published it far and wide that on a certain first day of April he would give the answer and award the prizes, or, as he aptly put it, "let the cat out of the bag, for the benefit of those most concerned."

The wording of the puzzle was as follows:

"A trained cat and dog run a race, 100 feet straightaway and return. The dog leaps three feet at each bound and the cat but two, but then she makes three leaps to his two. Now, under those circumstances, what are the probabilities or possibilities in favor of the one that gets back first?"

It looks childlike and bland, as Bret Harte would say, but the fact of the answer to be made public on the first of April, and the sly reference to "letting the cat out of the bag," was enough to intimate to the public that the great showman had some funny answer up his sleeve. Can you solve the puzzle?

A Study in Division.

Here is a cute little arithmetical study, told in the style of Mother Goose, which shows how in the days of auld lang syne the pedagogues were wont to punish the dunces in true Mikado fashion 'by making the punishment fit the crime."

The sketch shows three little dunces who failed ignominiously to do that simple sum in division on the blackboard, so, as the story says:

"Those stupid boys, who were so dumb,
They could not do a simple sum,
Were marked with numbers three, one, six,
And told those numbers they could mix,
And find by many changes tried
A sum which seven would divide!
You will say the answer is so plain
That all who fail, dunce caps should gain!"

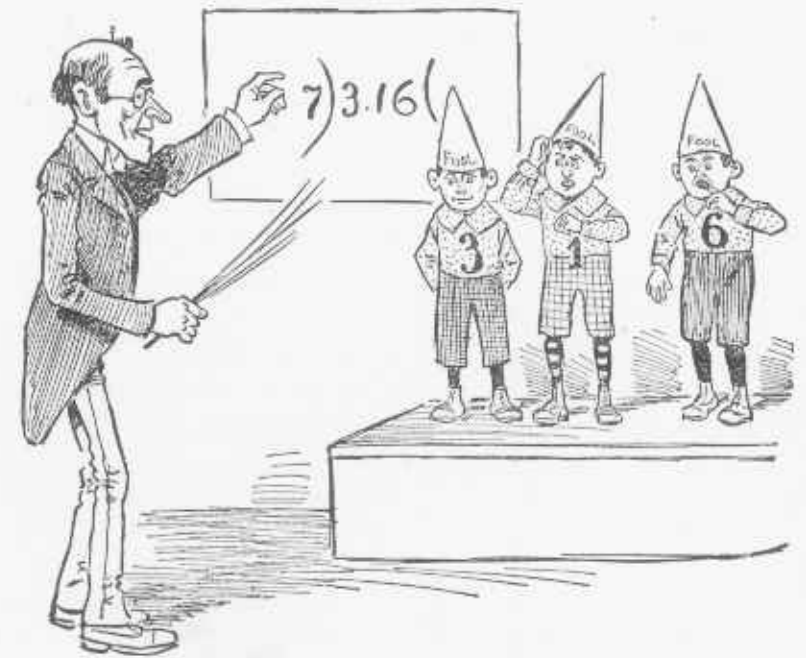

SAM LOYD'S PUZZLING SCALES

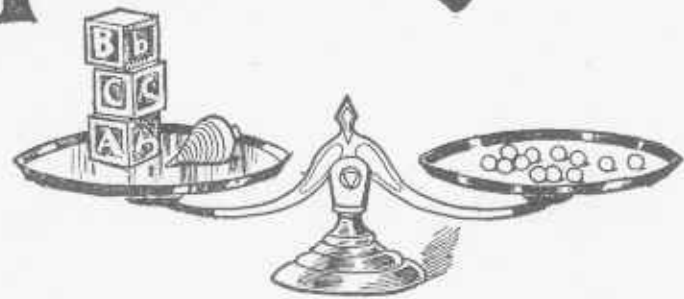

SINCE THE SCALES NOW BALANCE



AND BALANCE WHEN ARRANGED THIS WAY



THEN HOW MANY MARBLES WILL IT REQUIRE TO BALANCE WITH THAT TOP?

Elementary Lessons in Algebra.

To some people the idea of adding a b c to x y z, or multiplying letters together, seems the height of absurdity, and they fail to grasp the simplicity of algebra.

In the above puzzle we find a capital illustration of the principle of substitution and the adding of like quantities to both sides of an equation without affecting the equilibrium, so to speak, and an explanation of the reason for so doing to obtain other values. It shows the truth of the algebra axiom that "things which are equal to the same things are equal to each other."

In the first instance we see that a top and three cubes weigh equal to twelve marbles. In the second equation a top alone equals a cube and

eight marbles. Now let us add three cubes to each side of the second scales, and as the addition of equal quantities to both sides of an equation does not change their relative values, we have the same equilibrium. By the addition of three cubes to the second pair of scales we have produced the identical values as shown by the first scales. In the first case a top and three cubes = twelve marbles; in the second illustration we have proved that a top and three cubes = four cubes and eight marbles; therefore if four cubes and eight marbles weigh the same as twelve marbles, four cubes = four marbles, so a marble weighs just as much as a cube. It proves therefore that one cube and eight marbles, or nine marbles weigh equal to the top!

A Rebus

The Catholic Church my first maintains;
My next consists of poles and chains.
Distinctive whole—may'st thou ne'er brand
With foul disgrace our native land.
Cipher Answer.—13, 1, 19, 19, 1, 3, 18, 5.

A Rebus

Add two-thirds of an inn to a couple of asses,
You'll then see a brute that all other surpasses.
Cipher Answer.—1, 19, 19, 1, 19, 19, 9, 14.

A Rebus

My first denotes a company, of any art or trade,
My second is a holy maid, whose vows to God are made;
My third, though hollow in the head, can make a wondrous sound,
My whole creates a cheerful laugh when mirth and wit go round.
Cipher Answer.—3, 15, 14, 21, 14, 4, 18, 21, 13.

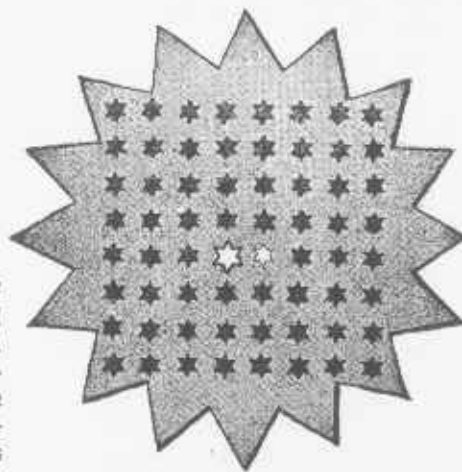

Here is an astronomical puzzle which is supposed to show the erratic path of the comet Heclai. Commencing with the small white star, show the shortest possible course through the exact center of all of the black stars so as to mark them all off and end with the big star.

In how few moves, in straight lines, could the comet Heclai destroy the entire constellation of sixty-two stars, beginning from and ending with the white stars?

MILITARY TACTICS BY SAM LOYD

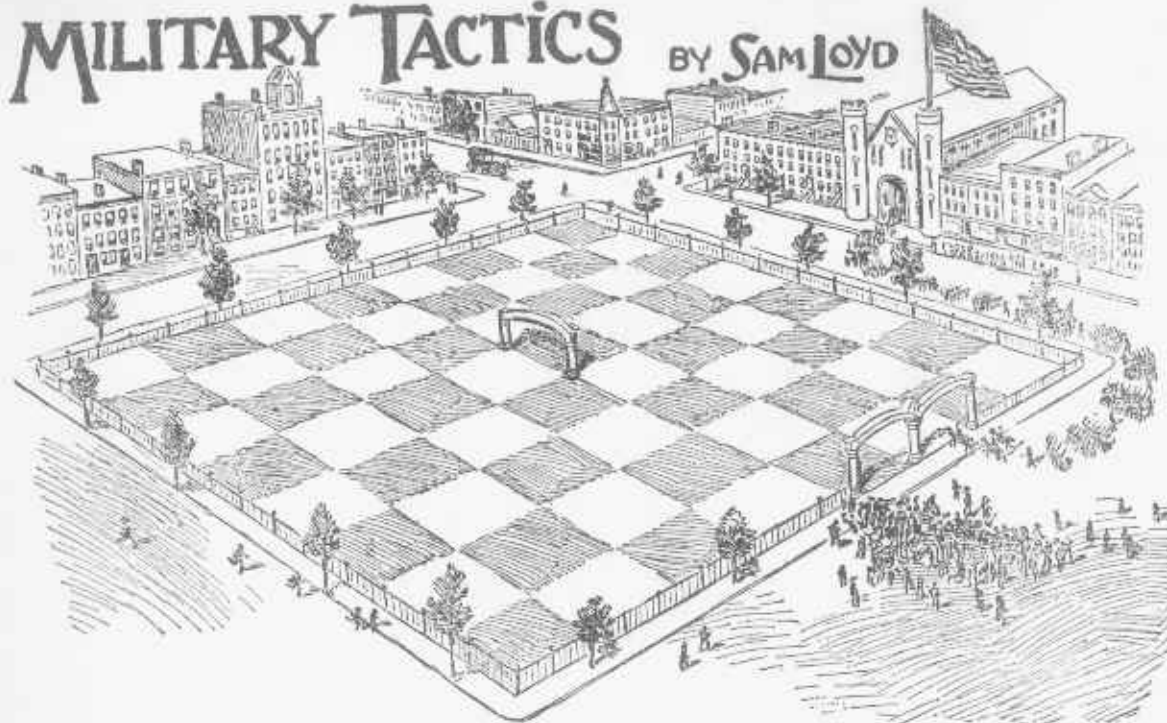

PROPOSITION—Show how a military division could enter at gate No. 1, march across all of the sixty-four squares and leave by the other gate, after passing under the triumphal arch.



SHOWING HOW

our earliest impressions cling to us through life, I recall that in addition to the pardonable pride which all Americans felt in the name of General Winfield Scott, my infantile imagination was fired by my father's holding me up on his shoulders during a military procession to see the hero who whipped the British at Chippewa and Lundy's Lane. I do not think that my mind has ever been entirely disabused of the impression then created, that General Scott was the greatest man that ever lived. The idea was probably intensified a year later when, during our war with Mexico, in 1847, father gave me a dog, and, as a matter of course, no boy ever forgets his first dog. It was given to me on the day of the battle of Monterey, and was appropriately christened "Monterey Scott."

When the Civil War came on in 1861, I, in common with others, predicted that General Scott would quell the war in short order. But our hero, who was born in 1788, was too old and infirm to stand the brunt of active service, and was compelled to transfer the leadership to McClellan.

Many yet live, however, who remember the sensation created by General Scott's remarkable saying to Secretary of War Stanton, to the effect that: "While we have scores of commanders who could march a division of soldiers into a park, not one of them knew enough about military tactics to get them out again!"

The remark was accepted as a scathing criticism of what were termed our holiday parade soldiers. I knew the veteran hero as a skillful chess player, and now recall the fact of building a curious chess puzzle, which I intended to present to him, if occasion occurred, to illustrate the military tactics of a division of soldiers passing through a public park.

It does not require a knowledge of the game, as it is a puzzle, pure and simple; but to facilitate explanation, I have taken the liberty of marking the park off into squares, which resemble a checker board. The problem, however, is quite pretty: Show how a military division should enter at gate No. 1, march through all of the squares under the triumphal arch, and out through gate No. 2, making the fewest possible number of turns.

Mark an 8 x 8 diagram of 64

squares upon a piece of paper and then essay with a pencil to pass over every square beginning and ending at the gates shown, and it is safe to say you will make several attempts before you get the shortest possible answer, which is so pretty that you will know when you have guessed it.

As a further elucidation of this same scheme which is suggestive of many other equally good ideas, let us look at the following puzzle which we will term "The Wanderings of Paddy's Pig." You see the garden gate was left open so that his pig-ship entered and rooted up sixty-four hills of potatoes and escaped by the same gate, after making what might be called 21 right-angled moves without crossing that black bar.

I am sure that the trick can be done in less than twenty-one moves and it is given as a puzzle for you to find out the fewest possible number of turns that the pig had to make to get all of the "murphies."

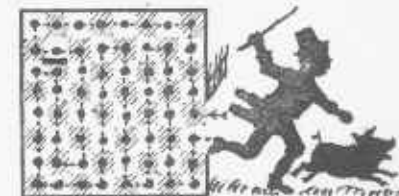

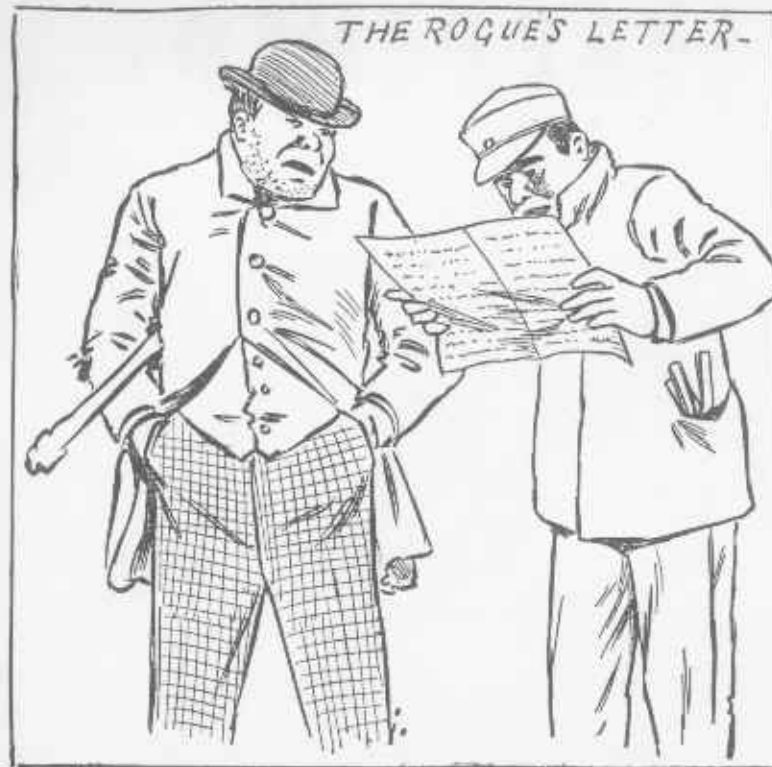

THE ROQUE'S LETTER.

I think it was Sherlock Holmes, or some other noted detective, who recovered the booty from some great bank robbery by playing burglar and joining the gang. He tells about receiving a rogue's letter which gave the names of certain cities which were to be visited, and which could readily be deciphered by the initiated. By way of illustration, let us look at the following rogue's letter, purporting to come from a noted pedestrian: "Dear Jim—I won the race. The track was at the Olympic, level and hard as cobalt. I more than won, for my position was central—eight before and eight behind. They had all a start from a half to a mile—to them a considerable advantage, but I can win on a run or walk and overtake and meander by—or kill—the best of them. Treading from early day to night the roads we follow.

ELLSWORTH."

It is a mixed-up sort of an epistle which will tax the ingenuity of our young puzzlists to decipher.

A Charade

I needed three and four,
And started for the door,
Thinking I would go for a three,
four and five.
I had not gone a square,
When by chance I total there,
By which I mean, you know, my one,
two, three, four, five.

A Rebus

When grandpa wished my first to make,
My second he would always take,
And handle it with skill.
Now, with your first tell me the name,
For whole and second are the same,
So guess it if you will.
Cipher Answer.—16, 5, 14, 11, 14, 9, 6, 5.
When can a moth grind corn?
When he is a miller?

SAM LOYD'S CONVENTION PUZZLE



"Mr. Chairman," said the secretary, "the call for a standing vote showed the motion to be carried by a majority equal to one-third of the opposition, but as that result was due to a lack of chairs to permit eleven

A Rebus
Deceitful, Godless, prone to deeds accursed
Must be the man whose ways are not my first.
When sterile winter holds its chilly reign,
My second may be seen on yonder plain,
Those who the path of honesty forsake,
My whole at last will surely overtake.
Cipher Answer.—10, 21, 19, 20, 9, 3, 5.

A Square Word Charade
The first cliffs tower o'er the sea,
Second, third, in land of Jews
Did fourth away a vast debris
And discovered Santa Cruz.
When speaks the fifth from her tower
Hearts faint or break that feel its power.

Answer to the above:
C H A L K
H E L E N
A L I V E
L E V E L
K N E L L

A Rebus

My whole a poet's name displays,
Whose fame will last for evermore;
Decapitate, and what remains
Does oft express what goes before;
Curtail my last, and mark the pains
Of industry to hoard a store.
Curtailed again, my head replace,
And you will greet a boyish face.
Cipher Answer.—4, 1, 14, 20, 5.

members from sitting down so as to record their votes in the negative, we wish to report that we find the minority has defeated the motion by a majority of one vote." Can you tell just how many votes were cast at this meeting?

WHAT HAPPENED.

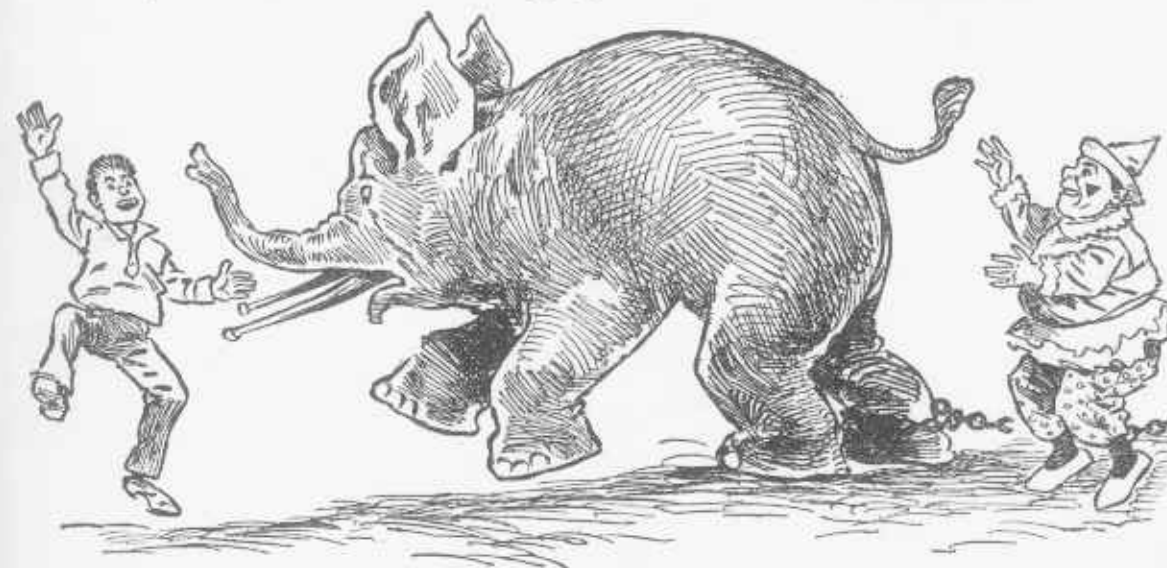

Here is a rollicksome little puzzle for the young folks, which presents possibilities for considerable humor and originality. The mischievous boy has been teasing the elephant at the circus, when the chain which held the elephant's hind leg broke and something happened! Just what that something was is left to the imagination and artistic ability of the puzzlist.

The elephant may have sat down upon that boy, or swallowed him, or stood upon his head, or in fact done anything which occurs to you. The only stipulation is that the picture must be cut into only two pieces, which are to be fitted together so as to explain what happened in the most humorous way, and the same will be reproduced as the answer to the puzzle.

Tell the North by Your Watch.

The following bit of valuable information is so closely akin to a puzzle that it is well worth giving at this season for the benefit of those who may utilize the same during their summer outings.

The incident occurred to me some years ago, but as the fact of every watch being a reliable compass is not generally known, it is worth telling. All you have got to do is to lay your watch flat in the palm of your hand, with the hour hand pointing in the direction of the sun, as shown in the accompanying sketch. The point

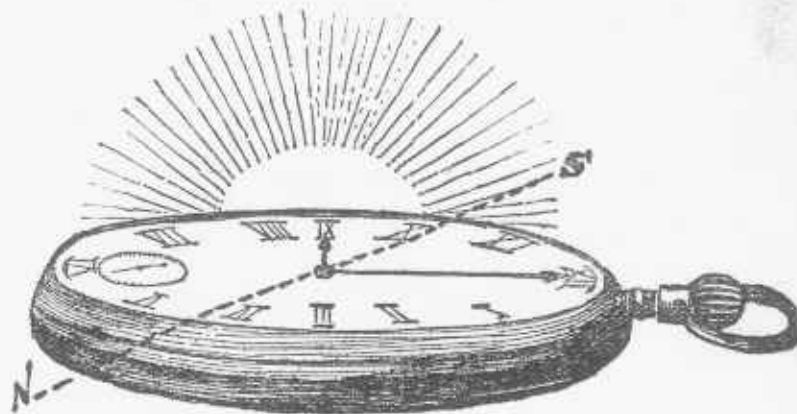

exactly midway between the hour hand and the figure 12 will be due south.

It is well to remember, however, that during the time from six in the afternoon to six in the morning our rules gives the north point instead of the south. In the southern hemisphere the rule will be reversed.

Some years ago, while taking a walk just outside of London, I was accosted by a stranger, who asked to be directed to a certain locality. I told him I was not acquainted with the names of the streets, but that if he would walk on east he would reach the desired place. I took out my watch and figured out the proper direction, at which he expressed great surprise, so I explained the method to him. I few days later I read the following paragraph in London Truths

"EVERY WATCH A COMPASS.
"A few days ago I was standing

by an American gentleman, when I expressed a wish to know which point was the north. He at once pulled out his watch, looked at it, and pointed to the north. I asked him whether he had a compass attached to his watch. "All watches," he replied, "are compasses." Then he explained to me how this was. (The modus operandi is explained above.) My American friend was quite surprised that I did not know this. Thinking very possibly I was ignorant of a thing that every one else knew, and happening to meet Mr. Stanley, I asked that eminent traveler whether he was aware of this simple mode of discovering the points of the compass. He said that he had never heard of it. I presume, therefore, that the world is in the same state of ignorance. Amalfi is proud of having been the home of the inventor of the compass. I do not know what town boasts of my American friend as a citizen."

THE MONKEY'S PUZZLE

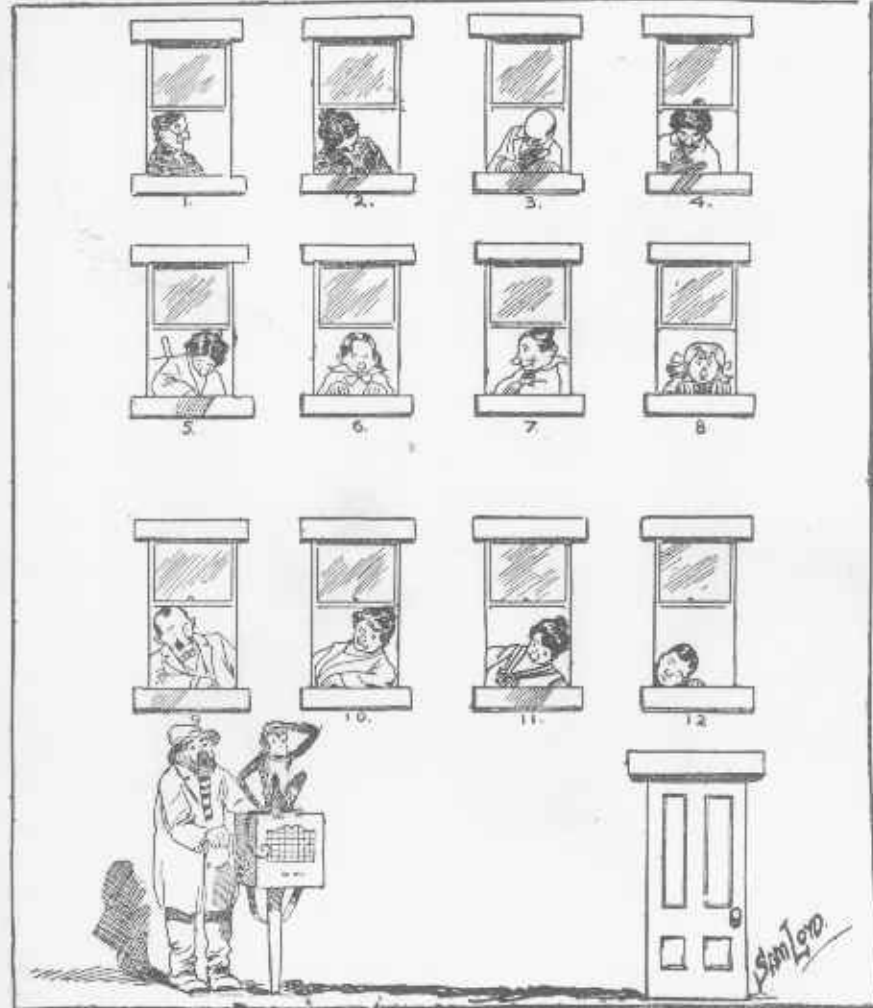

Here is the original story of the Seignor and the monkey house as told by an eye witness. You see, the organ had seen its best days and was sadly out of tune, but the Seignor's staying powers were inexhaustible and nothing short of a contribution from each of the tenants would bribe him to cease the eternal grind and move to other quarters.

Now that his audience is ready to capitulate, can you show Jocko the shortest possible route to clamber from window to window with his little tin cup to collect his dues, resting at last on his master's shoulder? The windows are numbered to facilitate a description of the monkey's route.

Here is an elementary study in arithmetic wherein you write down the names of all the articles, and

Can't Be Done.

You can't stand for five minutes without moving, if you are blindfolded.

You can't stand at the side of a room with both your feet lengthwise touching the wainscoting.

You can't get out of a chair without bending your body forward, or putting your feet under it; that is, if you are sitting squarely on the chair, and not on the edge of it.

You can't break a match if the match is laid across the nail of the middle finger of either hand, and passed under the first and third fingers of that hand, despite its seeming so easy at first sight.

You can't stand with your heels against the wall and pick up something from the floor.

Don't try to rub your ear with your elbow, for it will be a failure. It takes a clever person to stand up when placed two feet from a wall with his hands behind his back and his head against the wall.

A Rebus

I dwell where mighty billows roar,
Though sometimes cast upon the shore;
Beheaded, then, alas! you'll find
A name terrific to the mind;
Behead once more, if 'tis your pleasure,
And I become a simple measure.

Cipher Answer.—19, 8, 5, 12, 12.

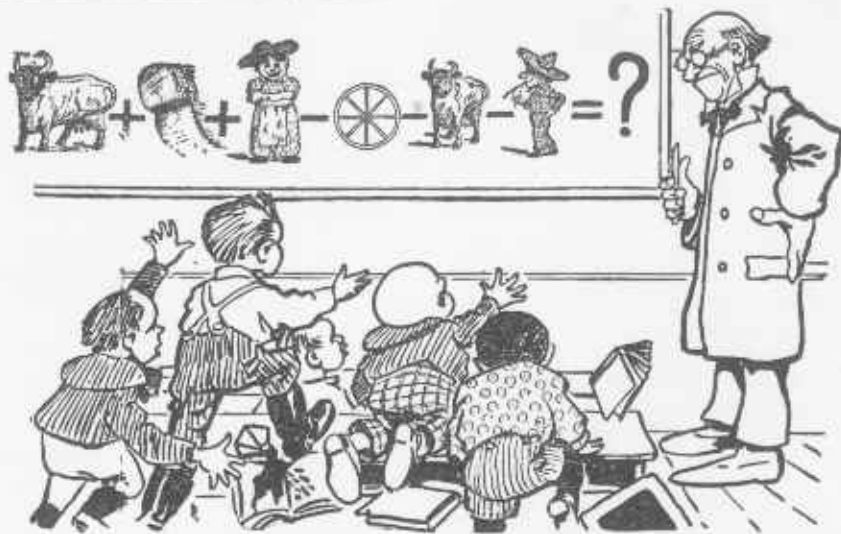

then cancel out all the — articles so as to tell what remains. If you guess the names correctly it becomes a very simple puzzle.

THE ST. PATRICK'S DAY PARADE BY SAM LOYD

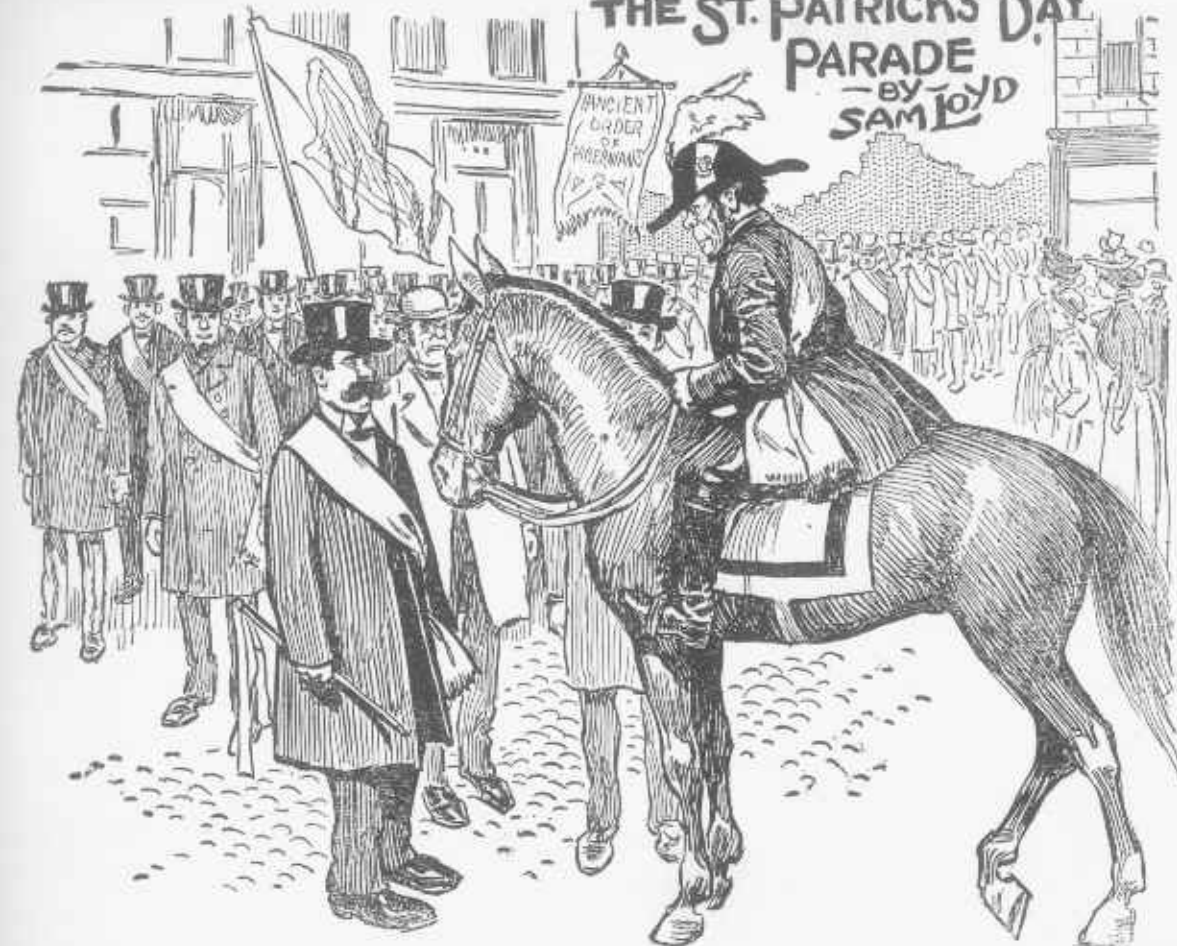

PROPOSITION—How many men were in the parade if it was always one man short in the last rank?

ANENT THE RECENT St. Patrick's Day parade an interesting and curious puzzle developed which bids fair to become famous. The Grand Marshal issued the usual notice setting forth that "the members of the Honorable and Ancient Order of Hibernians will parade in the afternoon if it rains in the morning, but will parade in the morning if it rains in the afternoon," which gave rise to the popular impression that rain is to be counted as a sure thing on St. Patrick's Day. Casey boasted that he "had marched for a quarter of a century in every St. Patrick's day parade since he had become a boy."

I will pass over the curious interpretations which may be found to the above remark, and say that old age and pneumonia having overtaken Casey at last, he had marched on with the immortal procession, and when the boys met again to do honor to themselves and St. Patrick on the 17th of March, they found

that there was a vacancy in their ranks which it was difficult to fill. In fact, it was such an embarrassing vacancy that it broke up the parade and converted it into a panic stricken funeral procession.

The lads, according to custom, arranged themselves ten abreast, and did march a block or two in that order with but nine men in the last row where Casey used to walk on account of an impediment in his left foot. The music of the Hibernian band was so completely drowned by the calls regarding what had become of "the little fellow with the limp," that it was deemed best to reorganize upon the basis of nine men to the row, as eleven would not do.

But again was Casey missed, and the procession halted when it was discovered that the last row came out with but eight men. There was a hurried attempt to form with eight men in each row; again with seven, and then with five, four, three and even two, but it was found that each and every formation always came out with a vacant space

for Casey in the last line. Then, although it strikes us as a silly superstition, it became whispered through the lines that every time they started off, Casey's "dot and carry one" step could be heard, and the boys were so firmly convinced that Casey's ghost was marching that no one was bold enough to bring up the rear.

The grand marshal, however, was a quick-witted fellow, who speedily laid out that ghost by ordering the men to march in single file, so, if Casey did follow in spirit, he brought up the rear of the longest procession that ever did honor to his patron saint.

The question involved in this puzzle is to determine just how many men there must have been in the procession. It is a pretty problem which will interest the young folks despite of its going somewhat into simple arithmetic, which many object to out of school hours.

THE MONAD PUZZLE



THE sign of the great Monad, which was unwittingly adopted as its seal by the Northern Pacific Railway Company, means to a Chinaman exactly what the cross does to a Christian. It is the sign of Deity, and represents eternity,—the everlasting, as Chinese scholars express it,—and is to-day an object of veneration to over 400,000,000 people.

It was adopted by the Northern Pacific Railway Company as a seal and trade-mark at the time of the organization of the company, and appears on all of its freight cars, bonds, stock certificates and advertisements, and it is familiar to everyone who has occasion to use the timetables.

It was adopted at the suggestion of Chief Henry McHenry, who says he had no conception of its Chinese significance, but merely intended it to represent certain mathematical proportions. This fact I have only just learned, so it will be interesting to know how far Mr. McHenry's views coincide with my own as given in the puzzle connected with it.

The best thing I ever heard about the sign was told to me by P. H. Tighe, the famous manufacturer of base balls, who got the idea of the two-piece cover from the shape of the monad.

Attention was first called to the significance of the symbol by Rev. W. S. Holt, who is a thorough Chinese scholar, and is familiar with its meaning through his connection with Chinese missions. Several works have been written on the symbol which prove its great antiquity, and in them are given the various interpretations which oriental scholars have put upon it. As a rule, these

explanations are so mixed up with oriental theology, such, for instance, as the Yin and Yan, the male and female forces of nature, and "the illimitable as adverse to the great extreme," that the reader feels as if he were investigating the Keely motor.

One writer on the subject is of the opinion that the sign has some recondite mathematical significance, and quotes ancient Chinese works as saying: "The illimitable produces the great extreme. The great extreme produces the two principles. The two principles produce the four quarters, and from the four figures we develop the quadrature of the eight diagrams of Feuh-hi." This was written more than three thousand years ago, and yet, so far as I can learn, has never been con-

nected with the mathematical "squaring of the circle," although it looks very much like it, and is suggestive of the following propositions:—

The first proposition is given as a simple puzzle for young folks. With one continuous line, divide the black and white parts of the Monad (the Yin and the Yan), into four pieces of the same shape and size.

The second proposition is to divide by one straight cut the Yin and the Yan, (supposing them to be two pieces already,) each into two pieces of the same size. This can also be done by those without any great mathematical ability.

The third proposition is to prove the "affinity" between the Monad and the "good-luck" sign, by converting the two horseshoes, as shown in Figures 1 and 3, into a perfect Monad, in the shortest possible way.



A Charade

My first, my second, and my whole,
Are every one the same;
In point of meaning, each and all,
An oft repeated name.

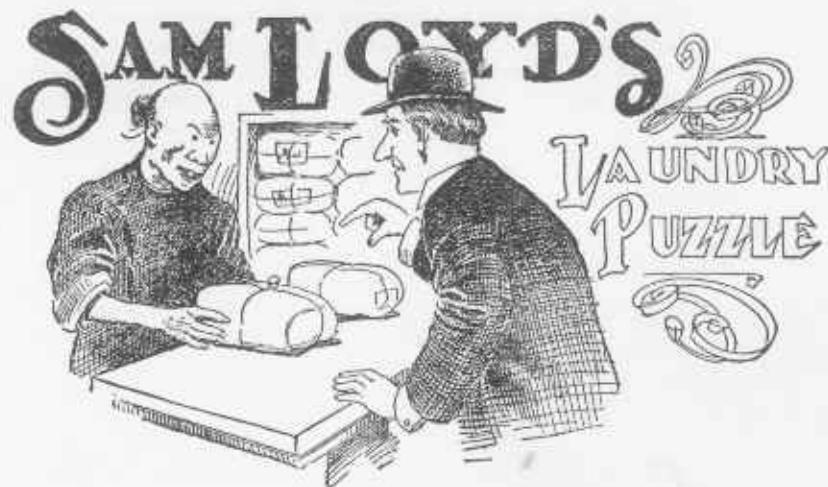

Charlie and Freddie having sent their lingerie, consisting of thirty pieces, to the wash, Freddie calls for the same and explains that as his bundle contains half of the cuffs and but one-third of the collars, it should

cost but twenty-seven cents. As four cuffs cost the same as five collars, Hop Lee, who is a poor mathematician, wants to know how much he must charge Charlie for the other package.

THE ALEC SMART PUZZLE BY SAM LOYD

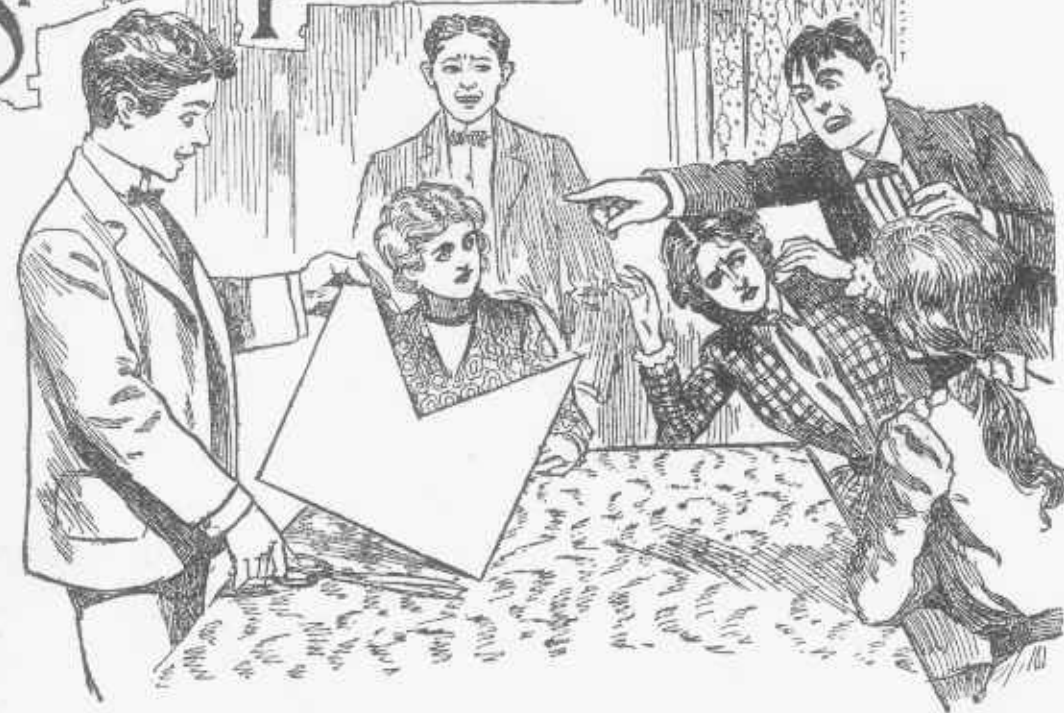

PROPOSITION—Cut the mitre-shaped piece of paper into the fewest possible number of pieces which will fit together and form a perfect square.

OF COURSE, ANY ONE who has ever presented a puzzle or trick to a party of friends is acquainted with Alec and his habit of showing, or attempting to show, that he knows all about the trick before it has been explained. In case he happens to have seen the puzzle, he gives away the answer before those who take interest in such matters have a chance to try it. Even when it is new to him, he aims to show how it resembles something else which he can readily demonstrate to be superior to this one. Generally his explanation reminds us of the Persian proverb of "He who knows not, and knows not that he knows not, is a nuisance," and it is a pleasure to squelch him, as in the following instance:

Harry is about to show his young friends a clever cutting puzzle, when he is rudely interrupted by Alec the Terrible, who believes it to be what is familiarly known among puzzlists as the famous old Mitre puzzle, which I sprang upon the public over fifty years ago, wherein the paper is to be divided into four pieces of similar shape and size.

In response to Alec's boisterous offer to explain the puzzle to every one, Harry promptly replies:

"All right! the puzzle is to cut this paper into the fewest possible number of pieces which will fit together so as to form a perfect square. I have forgotten the answer myself, but my friend here has kindly volunteered to explain it, so as to enable you all to win the handsome prizes which have been offered."

The puzzle is not so easy as it looks, and is liable to baffle an expert a long time before he hits upon the correct answer. The student will speedily discover that the principle of our old friend Pythagoras' problem is the key to the situation, in that it gives the size of the square to be formed.

Of course, there are innumerable ways of doing the feat by cutting the paper into many pieces, so you will readily discover one of these answers. Herein, however, lies the merit of the modern school of puzzles which gives great scope for ingenuity and skill, for while any one may find a fairly good answer a more clever puzzlist has an opportunity to discover a better one.

Here is an odd little puzzle for the juveniles, which is interesting as being one of my earliest productions, published more than half a century ago. It shows the original drawing as done by a lad of nine and is given to encourage young puzzlists to attempt similar work. It is told that three neighbors, who shared a small park, as shown in the sketch, had a falling out. The owner of the large house complaining that his neighbor's chickens annoyed him, built an enclosed pathway from his door to the gate at the bottom of the picture. Then the man on the right built a path to the gate on the left, and the man on the left built a path to the gate on the right, so that none of the paths cross!

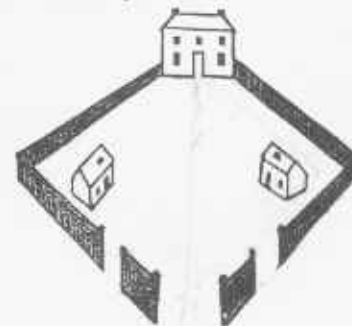

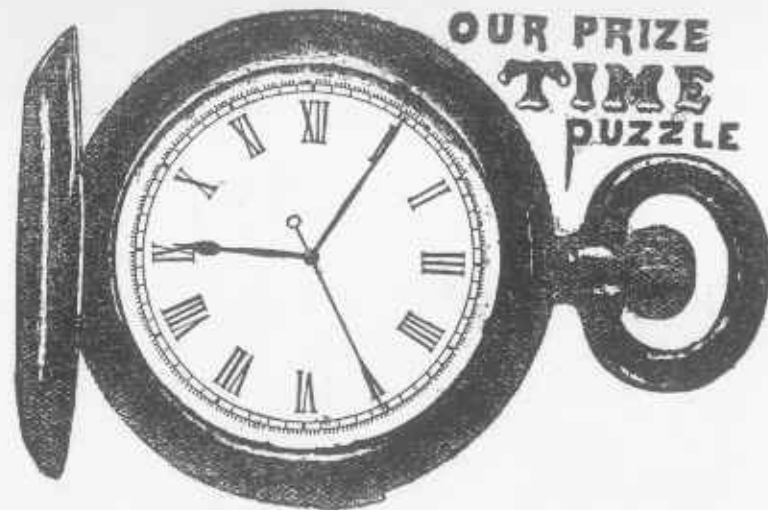

I STARTED two watches at the same time and found that one went two minutes an hour too slow, and the other one minute an hour too

fast, so that when I looked at them again the faster one was exactly one hour ahead. Can you figure out from the dial at what time before noon the watches must have started?

Here is another one which will puzzle you: How soon will the hour, minute and second hands again appear the same distances apart, as shown above?

Such problems are built upon the immutable laws of the divisions of time and are therefore purely mathematical and mechanical. There are 60 seconds to a minute, and 60 minutes to an hour, therefore there are 3,600 seconds to an hour, and that is all there is to it, although there are many clever and very puzzling problems connected with watches and clocks. When I was a very little lad I learned that a pendulum 39.1 inches long would beat a true second. I was very fond of running so I used to carry a bullet attached to a string of that length, which would swing from a pin stuck in the fence so that I could time the boys racing. I became infatuated with the sport and have run many races in all quarters of the globe and in innumerable cases can thank the early training of my legs for saving my skin, and at times my life.

I may say, while upon the subject, that to run 100 yards in 9 seconds is the limit of speed. I have seen it run in that time, but there is no professional living who can do it. Amateurs and smart boys, with the aid of a bullet and string will find their

speed to be somewhere between ten and twenty seconds, and may derive great pleasure, as by constant practice they reduce their record down the fraction of a second at a time.

For practical use the bullet and string may be 9.8 inches long then it will count half a second in its swing from right to left, or one whole second in the swing of forward and back; this enables one to count the half and quarter seconds.

The remarkable fact of a 39.1 pendulum beating a true second in its swing, whether it travels two feet each time, or one foot, or one inch, is the principle which regulates all clocks, and even watches. The hair spring connected with the escapement of a watch utilizes the elasticity of the spring in place of gravity.

The only obstacle to perfect time indicating is that the pendulums lengthen when the temperature is warm. This fault is overcome by ingenious compensating devices for correcting the length of the pendulum by the use of two metals of different expansive power.



I once constructed a clock out of wood which kept excellent time. Here is how I utilized the "grid-iron" principle to regulate the centre of oscillation. The rods A A are made of wood which expands but little from heat, B is made of metal which expands twice as much, so where A lengthens the pendulum a little, B expands twice as much and shortens it again.

Pendulums must be of different lengths in different parts of the

earth on account of the variable attraction of gravitation. The rule for getting the length of a pendulum is known by mathematicians as "pi times the square root of the length of the pendulum (in inches) divided by gravity."

A falling body goes 16 feet the first second; 3 times 16 the next second; 5 times 16 the third second, and so on increasing according to the odd numerals, 7, 9, 11 times as fast, and by this rule we make our clocks and watches! Here is a pretty problem to conclude with for the expert mathematicians to ponder over: If a pendulum vibrates as often in a minute as it has inches in its length, how long is it?

The watch was invented at Nurnberg at the end of the 15th century, but was of no practical value until Dr. Hooke invented the hair-spring in 1658. The time-keeping qualities of a watch depends altogether on the perfection of the escapement which performs the part of a pendulum. I have a \$1,000 Jorgenson repeater which rings the hours, quarters and minutes; times the horses and does all sorts of stunts. The manufacturer of an American watch presented me with a time-piece and asked me to keep a careful tally on the two watches for three months; I did so, and cheerfully give credit to the American product which beat the other out by one minute and ten seconds. To show my sporting blood, I offer to put up that watch against the best chronometer in the world, the one which keeps the best time for three months to take both watches. As a boy I remember reading about the days when they depended upon hour glasses and sun-dials, so I constructed a sun-dial which kept perfect time. Here is a pattern for the clever lads to follow after, which calls for no particular directions: Just paint the dial, as shown, upon a piece of board; let the pointer run up about at an angle of 45 degrees; set the dial very level with 12 pointing exactly north and the shadow indicates the hour. In the sketch it is pointing to half past one.

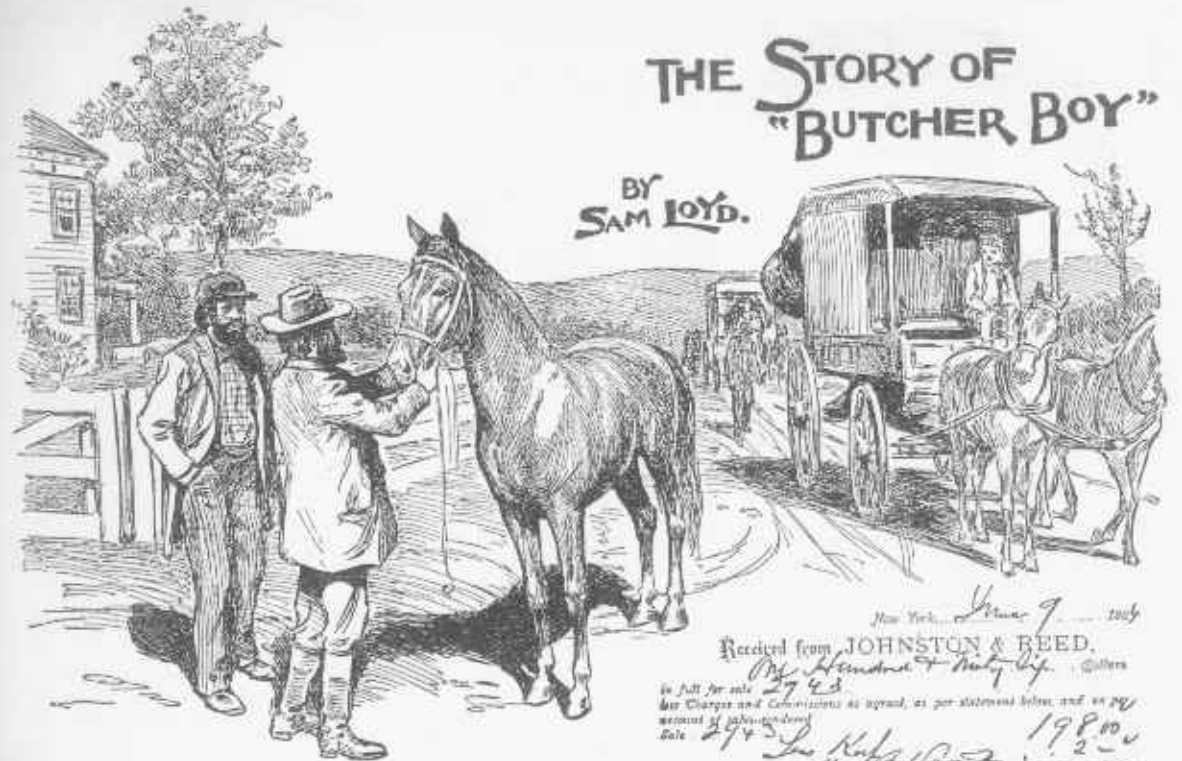

New York, June 9, 1904
 Received from JOHNSTON & REED,
 125 Broadway, N.Y. City
 in full for sale \$27.43
 less Charges and Commissions as agreed, as per statement below, and as per
 account of subscription
 Sale \$27.43
 198.00
 192.00
 196.00

NOTICING THE HIGH price recently paid at auction for an autograph of General Grant reminds me to say that I am the proud possessor of what I believe to be the last signature made by General Grant.

The story connected with it introduces a somewhat pretty problem, and induces me to pay a tribute to Grant's mathematical ability, at the expense of the many who have no love for figures. I take occasion here to say that while journeying through life and jostling up against all manner of people, the fact has been impressed upon my mind that with few exceptions all successful men were those who endowed with a ready faculty for correct mental arithmetic. On the other hand, there is a class of never-do-wells who guess or jump at conclusions in a reckless way, and cannot even figure up how much to pay on the dollar when the inevitable smash comes.

I could mention a dozen incidents connected with great men as illustrating their aptitude for correct calculations, but this one will suffice to call attention to Grant's aptitude for figures.

We all remember the story of how he figured his way into West Point, after that memorable journey for a pound of butter, when he

he heard of the chance for a competitive examination. Professor Agnell, the master of mathematics at West Point, with whom I used to play chess, used to say that "Grant had a great love for mathematics and horses."

Grant did love a horse and could pick out the good qualities at a glance, and, oh, my! how he despised a man who would abuse a dumb animal!

My story turns upon an incident as told by Ike Reed, of the old horse mart of Johnson & Reed, who gave me the autograph from their sales book of 1884, as photographed in the picture. During the last term of his Presidency General Grant returned from his afternoon drive and in a humorous but somewhat mortified way told Colonel Shadwick, who kept the Willard Hotel, that he had been passed on the road by a butcher cart in a way that made his crack team appear to be standing still. He said he would like to know who owned the horse and if it was for sale.

The horse was readily found and purchased from an unsophisticated German for half of what he would have asked had he known the purchaser was the President of the United States. The horse was of light color and was none other than Grant's favorite horse, "Butcher Boy," named after the incident

mentioned. Well, some years later, after the Wall street catastrophe, which impaired the finances of the Grant family, Butcher Boy and his mate were sent to the auction rooms of Johnson & Reed, and sold for the sum of \$493.68. Mr. Reed said he could have gotten twice as much for them if he had been permitted to mention their ownership, but General Grant positively prohibited the fact being made known. "Nevertheless," said Reed, "you come out two per cent. ahead, for you make 12 per cent. on Butcher Boy and lose 10 per cent. on the other."

"I suppose that is the way some people would figure it out," replied the General, but the way he laughed showed that he was better at figures than some people, so I am going to ask our puzzlists to tell me what he got for each horse if he lost 10 per cent. on one and made 12 per cent. on the other, but cleared 2 per cent. on the whole transaction?

It may be mentioned incidentally that General Grant stated that he had presented one of the horses to Mrs. Fred Grant, and as shown in the receipt signed for her.



THE GOLD BRICK PUZZLE

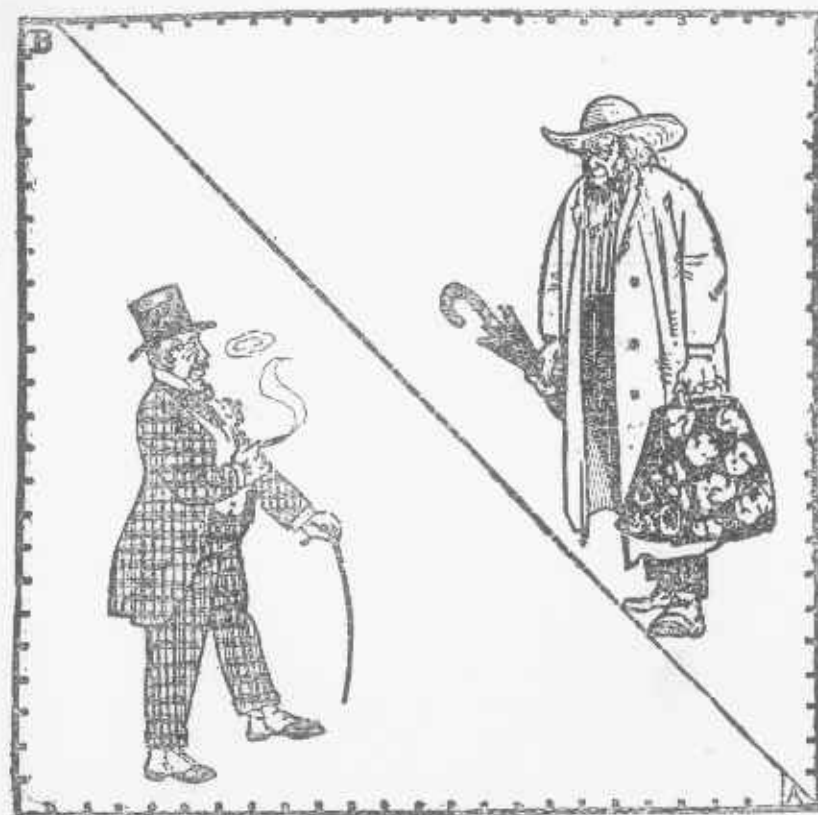

This puzzle shows how easily a person may be deceived in buying gold bricks. Things are not always what they seem. For example, take the accompanying picture for a pattern, and cut any size piece of paper exactly square. Then mark off 24 points on each side, microscopically correct if you can do so. This, for the time being, we suppose to be the gold brick, which is commonly purchased from the affable stranger whom one meets at the hotel.

Each side of the border being divided into 24 equal spaces; note that if the small lines were continued across from border to border in both directions, there would be 24 times 24, or 576 small squares. If these marks were one inch apart, then Mr. Hayseed would be buying 576 square inches of gold! Do you see that diagonal line, running from the corner *A* up to the second mark near *B*? Now, cut on that bias line end. Move the top piece up one space on the incline and snip off the little triangular piece *A*, so as to fill in the top left hand corner. Now re-measure the sides of the gold brick by counting the number of spaces along each side, and see if there are

as many small squares as there were before. In other words, see if it is not 23 inches wide by 25 long. That would make but 575 inches of gold that Rubens got and he thought he was buying 576, so it is safe to say that it is not even gold that he purchased, but only brass, worth about 20 cents a pound!

Now, put on your serious thinking cap and study it out: The first measurement was actually 24x24 and contained 576 square inches. Now measure off those points as carefully as possible, the more accurate your measurements are the more inexplicable will be the mystery, then give me the correct dimensions of the rectangle so as to tell what has become of that missing square! This puzzle which I promulgated in my early youth, is a decided improvement upon the time-honored problem of the cut-up checker-board which I have already discussed and presented in modern form.

Euclid, the famous mathematician of Alexandria, who flourished 300 years before the Christian era, with his great work upon geometry which formed the groundwork of all that is known of the sciences. The first

volumes contained elementary rules and theorems, accompanied by rigid proof of their accuracy; but the last volume, which was devoted entirely to problematical fallacies, was unfortunately lost. That work, which might be looked upon as the culmination of his labors, must have been the grandest book ever attempted by the author. It has been described as a collection of problems or puzzles, wherein the student was to test his knowledge of the subject by detecting the fallacy concealed in the puzzle.

The gold brick problem is given as an illustration of a series of puzzles which I have planned to carry out Euclid's line of teaching, and which will be found to be scattered lavishly through these pages, always accompanied by explanations which will prevent the student from being misled.

The Hindoo Flower Trick.

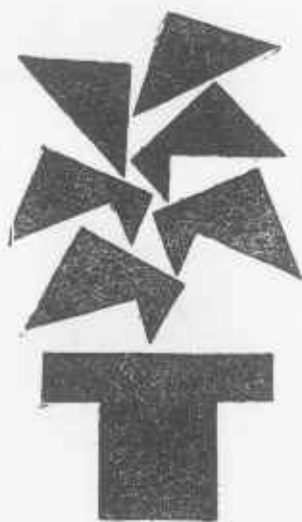

Here is an illustration of the famous Hindoo Flower-trick. The fakir plants a seed in the hat and a beautiful flower at once appears; then he asks you to take the seven pieces and arrange them so as to form a Greek cross.

A Rebus

To thee my first in days of yore,
A king has kneel'd with feelings sore;
His loss my next will bring to view,
But hope my whole rests not on you.
Cipher Answer.—2, 12, 15, 3, 11,
8, 5, 1, 4.

THE HALF-ORPHAN.



PROPOSITION—What is the poor little half-orphan kicking about?

ACCOMPANIED BY Sherlock Holmes, the famous detective, I dropped into Dauber's studio one morning and found that talented young artist putting the finishing touches to a bit of canvas. He welcomed us effusively and exclaimed: "You are just the fellows I want. Here is an odd thing I have just finished for the exhibition, and am so bothered for an appropriate name that I will give a prize for the best suggestion."

"It would be like robbing you to take the money," said Sherlock. "The piece has its name written all over it, as any one with half an eye can see. It is a sketch from life which you have picked up on your travels. The father has just died, so, if it were not vulgar to pun, I should say the child's loss was apparent. The gay young widow contemplates marrying again, and the child is neglected and objects, and that is where the trouble begins. That, as well as many other points as plain as the nose on your face, are too simple to mention. It would be too commonplace to suggest that the child is crying over spilled milk, for his grief is deeper rooted than that. The only question worth discussing is to tell what the kid is kicking about, so I suggest it be called the half orphan, and for the best answers to that conundrum, it might be interesting to offer some valuable prizes.

The picture carried off the honors of the exhibition of course, and is now quite noted for having brought fame and fortune to the artist. The name "Half-Orphan" in itself was a happy hit, which the public for some inexplicable reason seems

to have interpreted as being singularly appropriate. Although outside of the three persons who were present at the christening, not a living mortal knows why it was so called, the solvers who now carry off the honors of this little competition will unravel one of Sherlock Holmes' characteristic mysteries. Don't miss the point of the query: What is the poor little half orphan kicking about?



A Message in a Bottle.

Among the specimens of flotsam and jetsam which the tides and drifting sands cast at times upon the beach, nothing compares in interest with bottled messages, supposed to be the farewell words of shipwrecked humanity, giving a graphic description of the fate which had befallen some long lost and almost forgotten vessel.

Such messages from the sea, in times past have told wonderful tales of shipwreck, privations and narrow escapes in a way that suggested the possibilities of the writers being still alive in Arctic regions or on unknown islands, which, in some instances, have been fully confirmed. In the British collection of such tales as have been officially investigated and authenti-

cated are many proven to be true, which furnish clues to the fate of ships lost hundreds of years ago, showing that the messages cast upon the waves had drifted for centuries in mid-ocean before effecting a landing.

As a rule, the modern style of the paper, to say nothing of the year 1905 shown on a champagne bottle should throw some doubts upon the genuineness of the document, nevertheless, the subject bears such a fascinating charm that the finders will not be influenced by such arguments as might discredit the truth of the wonderful narratives.

Here, for instance, is an oddity presented in puzzle form, assumed to have been written ages ago, and yet in these brief lines it tells so well its story that we can not only compute the probable number of centuries spent in drifting about, but we can tell the name of the writers. So positive are we about these facts that such little things as the name blown in the bottle; the modern style of language, as well as unlikelihood of a shipwrecked mariner taking time to construe his last message in verse, carry no weight whatever. All we have to consider is the paradoxical or unnatural statements of the writer, which from their very unreasonableness furnish "confirmation strong as holy writ:" Now, who wrote it?

A mighty ship I now command,
With cargo rare from every land.
No goods have I to trade or sell;
Each wind will serve my turn as well;

To neither port nor harbor bound,
My greatest wish to run aground.

What would you call a boy who eats all the green melons he can get? He is what we call a pains-taking youngster.

What is an eaves-dropper? An icicle.

Why is a neglected damsel like a fire that has gone out? Because she has not a spark left.

Why are bells used to call people to church? Because they have an inspiring influence.

What is that which goes up the hill and down the hill and yet stands still? The road.

What becomes of the chocolate cake when your only son eats it? It vanishes into the empty heir (air).

When is a bill like a gun? When it is presented and discharged.

THE CHEESE PROBLEM

—BY—
SAM LOYD.



SPEAKING ABOUT the way that puzzle ideas come to us it may be said that the theme for a good puzzle can be suggested by anything striking or novel that one chances to see, but the application or proper working out of the scheme may require considerable time and study. Something in the ordinary affairs of life puzzles us a little by its oddity, and the thought naturally occurs, "If this thing perplexed me in its accidental form, when no feature of difficulty was intended, how would it be possible to increase the difficulty by dressing it up in true puzzle form so as to conceal the principle involved?"

The problem must be posed in pleasant shape, so that the picture aids in explaining the terms and at the same time conceals its real difficulty by imparting what Bret Harte would term a "childlike and bland" simplicity to the whole story. The very name may be utilized to draw attention away from the trick, for, as an old philosopher remarked several centuries before they spoke United States, "Ars est celare artem," by which he meant to inform puzzle-makers that the true art is to conceal the art. Therein lies the main difference between modern and old time puzzles.

Chancing one day to be in a com-

missary department when an assistant was portioning out cheese, I was struck by the ingenious way in which he divided it, and the more I thought it over the more firmly I became convinced that I was indebted to the visit for a happy suggestion which would eventually crystalize into puzzle form. I complimented the quartermaster upon the skill of his assistant, to which he replied: "Oh, that is nothing! You should see him cut pie!"

I never had the opportunity of witnessing his proficiency in the dispensation of pie, but it seemed as if a piece of pie and cheese had got stuck in my crop and disturbed my mental digestion from that moment, until one day being called upon to produce an original puzzle, I drew a circle and called it the legend of the boarding house pie, which has since become famous.

The cutting of a piece of pie pertains only to the superficial surface, as it goes no farther than square root or the second power, as the mathematicians would say. In the portioning of cheese we go below the surface into cubic equations known as the third power, for we have to consider the feature of depth.

Can you tell how many pieces are produced by the following six straight cuts?

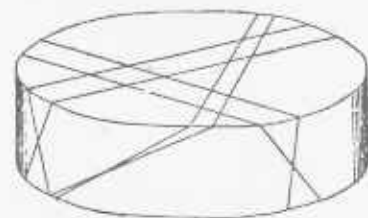

Passing the Japanese Mines.

The section of a chart of Japanese mines placed at the entrance to the harbor of Port Arthur is presented for the benefit of the young puzzlists, who are asked to show how a vessel might pass from the bottom to the top of the picture by changing her course but once. Draw a straight line from the bottom of the picture to a certain point, from which you can draw another straight line to the top, so that the two lines will indicate a safe channel through the twenty-eight mines or torpedoes.

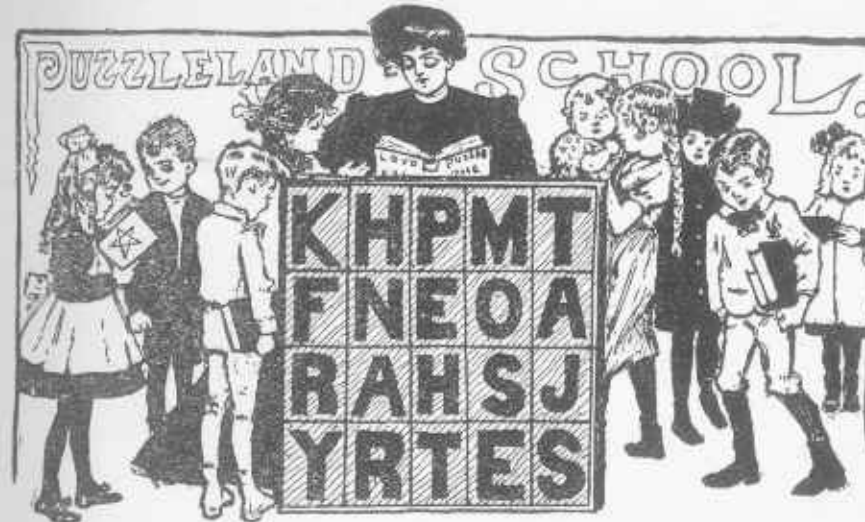
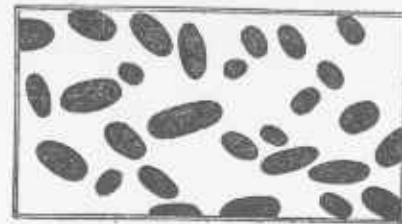

Here is the patch quilt which the scholars presented last Christmas to their teacher in puzzleland. You will find the names of all of the boys hidden among the letters. Just spell from one letter to any adjoining one on the square or bias as the ladies say. Beginning with **J** you can spell **JAMES** as shown, but how many scholars do you think there were in all?

SECRET CYPHER.

Here is a specimen of the code used by Washington during the Revolution, with which some may be familiar. It appears to pertain to a complicated system wherein the words are numbered and not spelled out. In the translation the 11, 15, and 26 words are *of*, and yet they appear in the cypher as 420, 248 and 570. It was a letter written by Governor Morris to Gen. Nathaniel Greene, at the very time that Washington has been accused of winning American Independence by questionable strategy. It was publicly asserted that Clinton was to be attacked in New York, which prevented assistance from being sent to Cornwallis in Virginia. The letter it may be seen, is dated just before the grand coup:

Phila., 11 Sept., 1781.

Dr General: The enclosed Cypher is that referred to in my Letter as well as in that from the Superintendent of Finance. It is the Cypher also of which the Commander-in-Chief has one Duplicate, and consequently when you shall have received it you will be able to correspond with him, for which Purpose you will let him know that you have it.

In order to explain more fully the Use take the following sentence: "Sir Henry Clinton threatens an attack on Philadelphia by way of Diversion in favor of Lord Cornwallis; this has a little intimidated some few Ladies of my Acquaintance."

This being put into Cypher will stand thus:

A Cipher Dispatch Puzzle.



Of course there are a thousand and one different kinds of secret cipher codes for sending written or telegraphic messages. Some are difficult, while others yield readily to systematic or experimental analysis. The one most generally employed is the mixing up or transposition of the letters, which may be easily guessed, however, by finding from an ordinary column of reading matter the average frequency of the occurring of the different letters. To test your ability in deciphering that well known method, we give the following puzzle and ask for the answer.

Qdt kj jksbjd tft gefwqj rj bid terwn wrgedw tefi dqddi teedi eba hkge sbwdw rj dqddi tefi gefwqj?

It will be found to involve an arithmetical proposition, which you may answer if you have deciphered it correctly.

13, 53, 64, 530, 555, 140, 290, 319, 225.

613, 430, 248, 530, 24, 248, 225, 23, 613.

239, 500, 137, 436, 556, 85, 570, 114, 563, 500.

319, 491, 570, 34, 556, 438, 376, 118, 346, 290, 341, 524, 405, 169, 615, 341, 225, 225, 290, 319, 603, 263, 331, 581, 63, 539, 423, 406, 85, 556, 180, 23, 537, 319, 225, 650, 184.

I am very truly yours,

Gouv. MORRIS.

A Rebus

My first beneath my second's seen,
And moves at pleasure there;
My whole's an arch of beauteous mien,
Set up without a pier.

Cipher Answer.—5, 25, 5, 2, 18, 15, 23.

A Rebus.

My first's the heart of honest trade,
When 'tis judiciously displayed;
But when 'tis of its head bereft
It then becomes a public theft.

Cipher Answer.—19, 16, 5, 3, 21, 12, 1, 20, 9, 15, 14.

WEARY WILLIE AND TIRED TIM PUZZLE

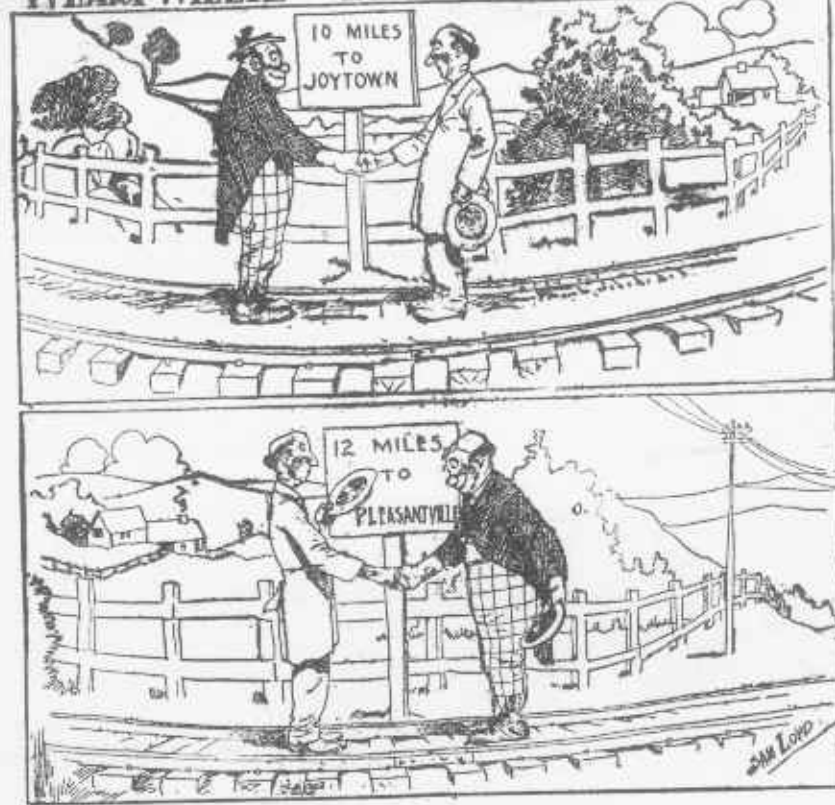

"As showing how valuable knowledge, improving to the mind, may be learned from incidents which may occur to a gentleman of leisure during a summer's outing," murmured Weary Willie, during one of his reminiscent moods, "I recall a chance meeting with Tired Tim on an urban branch of the D. L. & W. We exchanged the sign, password and fraternal grip and became acquainted at once. It appeared that a change from Joytown air was recommended for him at the same time that I was persuaded that it would be better for my health to leave Pleasantville. That is how we came to meet at a point ten miles on the road."

"We fraternized just long enough to become chummy and swap diaries according to rule and then jogged on to our different destinations.

"Both towns proved to be overworked, and secret association marks showed the people to be so mercenary and uncongenial that it would be waste of time to tarry.

"Accepting the escort of the attentive policeman who invariably recommended traveling gentlemen to return by the same route to where

they came from, we started as it appears, simultaneously on our return trips.

"That is why, as shown in the sketch, that I again met my erstwhile acquaintance, at a point twelve miles from Pleasantville, but I'll go you the beers that from the data given you can't figure out how many miles it is from Joytown to Pleasantville."

Of course, it is assumed that each of the pedestrians maintained his own respective gait, both in going and coming from one town to another.

A Pictorial Charade



When I was traveling through Puzzle Land, where every sign is a puzzle, every question a riddle, and you must guess the name of everything you eat, I saw this sign over a livery stable. Can you tell me what it meant?

A PROBLEM FOR A JURY.

JUDGES are sometimes called upon to solve knotty points of law, which would bother the average puzzlist. Here for example is an old-timer which, so far as I am aware, has never been answered satisfactorily:

Polus instructed Ctesiphon in the art of pleading, and it was agreed between teacher and pupil that the tuition fee should be paid when the latter should win his first case. Some time having passed by, and the young man being without clients and evincing no ambition to secure business, Polus, in despair, brought the matter before the court. Each party pleaded his own case, and Polus, speaking first, said: "It is indifferent to me how the Court may decide this matter, for, if the decision be in my favor, I recover my fee by virtue of the judgment; but, if my opponent wins the case, it being his first, I obtain my fee according to contract."

Ctesiphon, who was evidently an apt scholar, replied: "The decision of the Court is even of less importance to me, for if the verdict is in my favor I am thereby released from my debt to Polus. But if I lose the case, the fee cannot be demanded according to the contract."

A still more interesting case is said of a certain king who built a bridge and decreed that all persons about to cross it should be interrogated as to their destination. If they told the truth they were permitted to pass unharmed, but if they answered falsely they were to be hanged on a gallows erected at the centre of the bridge. One day a man about to cross was asked the usual question, and replied: "I am going to be hanged on that gallows!"

Now, if they hanged him, he had told the truth and should have escaped, whereas if they did not hang him, he had answered falsely and should have swung for it.

A Rebus

My first's possessed by all mankind,
My second skims the wave;
My whole will dash through wave and wind.

In hopes my first to save.

Cipher Answer.—12, 9, 6, 5, 2, 15, 1, 20.

THE PIG-STY PROBLEM BY SAM LOYD

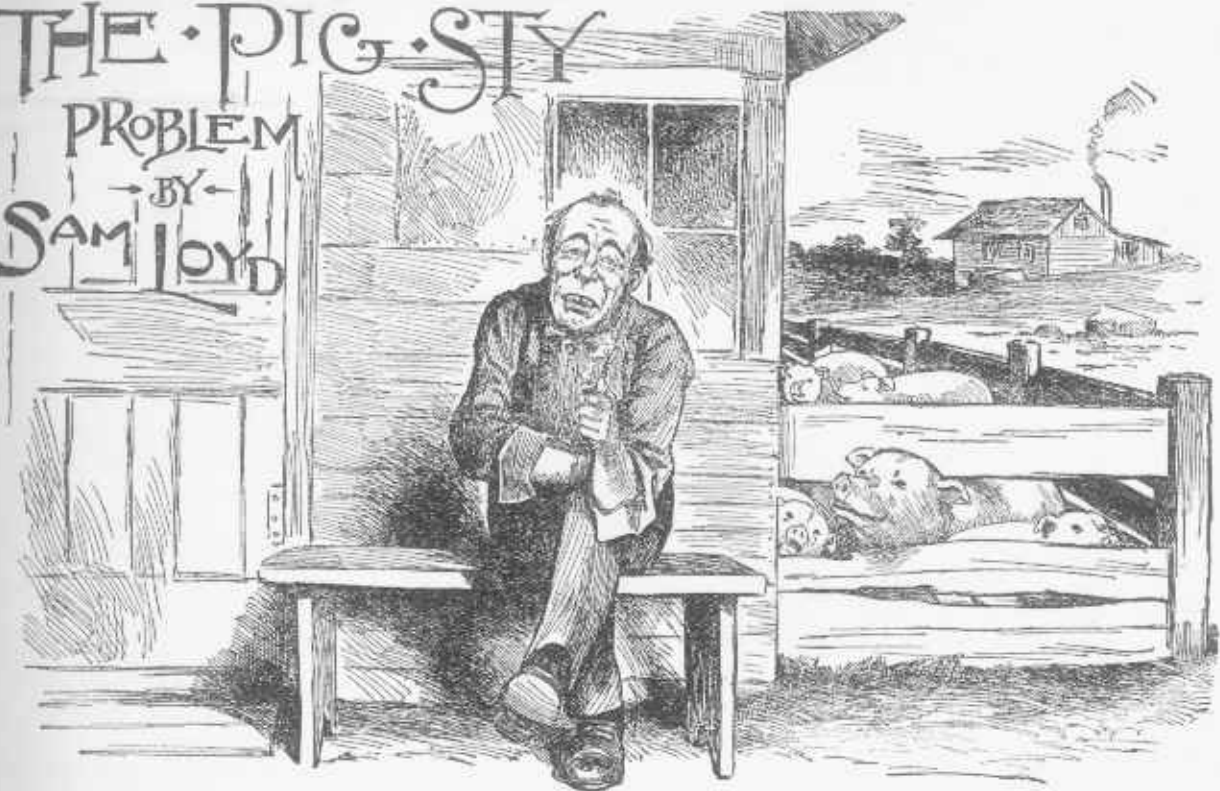

REPLYING TO THE oft-repeated query as to how puzzles are originated; whether they come spontaneously like sudden inspirations or as the result of long and careful study, I would say that like the development of any other inventions, they come either way: from a happy thought or from hard work, although in either case the idea is generally suggested by some chance incident.

By way of illustration I will say that during my summer's outing, while scouring the country en-wheel, I ran up against a good-natured Hibernian whose apple orchard and spring of cool water made his little shanty a veritable Mecca for weary bicycle pilgrims. He was a unique character, and few of us ever came out first best with him in a passage of wits, as he had an inexhaustible stock of replies at his tongue's end ready for anything that could be fired at him.

It will be interesting to know how he takes to the idea of being immortalized in print when he sees the sketch I made of him seated in characteristic pose at the door of his domicile. The original picture, neatly framed, has been sent by express to grace his "drawing room" in acknowledgment of "one on the puzzler."

You see, I was so foolhardy as to intimate that there was a certain bond of fellowship between us because we both made our living by the pen, which seemed to touch him in his most tender spot, for he asked in his earnest way if I knew why an Irishman always builds a pig pen under the drawing room window? Then, after I had suggested every practical explanation and completely exhausted my repertoire of conundrums, appropriate or otherwise, he told me in a confidential whisper which could be heard a mile that "it was built there to keep the pigs in." He begged me not to tell the reason to the rest of the party, who might think it a joke. During the journey home there was not one of that party who did not fall off his bicycle a dozen times in thinking over Pat's problem. Of course I thought of it as well, and there was one statement concerning his pigsty which struck me as being so "odd" that I utilized it to get even on the rest of the crowd. I can not tell it in Pat's own language, but it appears that, believing with Rory O'More in "the luck of odd numbers," he had made it a rule to "bring up," as he suggestively termed it, just twenty-one pigs every season. To accommodate them he built the pen under the drawing room window, dividing his

happy family into four groups, so that each pen contained an even number of pairs and one odd pig. It looks like an easy little problem to divide twenty-one pigs in that way if you say it quick, but just try it!

If you understand the mystery of Shakespeare's "divinity of odd numbers," show how Pat placed his twenty-one pigs in four pens so that each pen contained that odd little porker.

Peterchen's Pretzel.



Here is a simple little marking problem for the juveniles who have found the other problems somewhat difficult. Little Peterchen had a Vienna twisted pretzel, as shown in the drawing, and asks his young friends to guess into how many pieces he divided it with one straight cut with a knife. Supposing it to be a real pretzel, draw a straight line which would divide it into the greatest possible number of pieces.

DUCK SHOOTING AT BUZZARDS BAY

Problem by Sam Loyd



PROPOSITION—By changing the position of the fewest possible number of the ten ducks arrange them so there will be five rows of four in line.

THE SUBJECT OF this puzzle inspiration is a familiar one to residents of the vicinity of Buzzard's Bay and introduces one of the many problems which, aside from the mere question of a hunter's luck, have doubtless been noticed by such as revel in the pleasures of duck shooting.

Next to shooting the chutes, there is no salt water sport so exhilarating as gunning for ducks, and there are few problems of a political or economical character which call for such profound statesmanship and administrative ability to show a balance sheet in favor of the internal receipts of the game bag, as against the expenditure of powder and shot, to say nothing of the other lavish expenditures which pertain to the make-up of a great duck hunter.

There are a thousand and one problems connected with the game, any one of which would be worthy of consideration, but with which our puzzlists are doubtless more familiar than myself, so I only refer to one little proposition which may be peculiarly characteristic of my style of duck shooting. Of course it is a great feat to get more than one duck at a single shot, and as that can only be done by getting several of them in a line, it set me to studying the

principle upon which Buzzard Bay ducks line up, and I may have hit upon something which my uniform lack of skill as a marksman enabled me to discover.

I noticed that the birds invariably approached in two rows, with a corporal bird, so to speak, on each side in charge of either line, so that, as shown in the sketch, one could figure out three lines of four-in-row. Now just as soon as I got a line on four of these birds I would blaze away in the hopes of getting several birds with one shot. I could readily have killed one bird or possibly two, but my ambition to get four or none led to the result of my making the following interesting discovery. As soon as the smoke cleared away, so that I could open my eyes, I would find that the ten birds had reversed their direction, and were shooting away like a company of Filipinos, to reorganize somewhere back in the swamps. What I particularly noticed, however, was that while they came in the three four-in-a-row form as shown, they invariably scooted away in the shape of five rows, with four-in-a-row. Just how they made the change I never could see, on account of the smoke and confusion, but I noticed that the fewest possible number of birds had changed their positions, so it will afford me

special pleasure to give credit to any lucky duck who will solve this little problem for me correctly.

The picture shows ten ducks advancing in geometrical form, showing three rows of four-in-line. Now reorganize them so there will be five rows of four-in-line, simply by changing the position of the fewest possible number of ducks and it will incidentally show how many ducks Grover bags out of the flock.

The problem can be worked out practically by placing very small counters upon the ducks in the picture and move them around until you get five rows of four-in-a-row.

A Tricky Problem.

Ask your friends if they can write down five odd figures to add up and make fourteen.

It is really astonishing how engrossed most people will get, and how much time they will spend over this, at first sight, simple problem. The questioner, however, must be careful to say figures, not numbers.

Here is the answer:

11
1
1
1
—
14

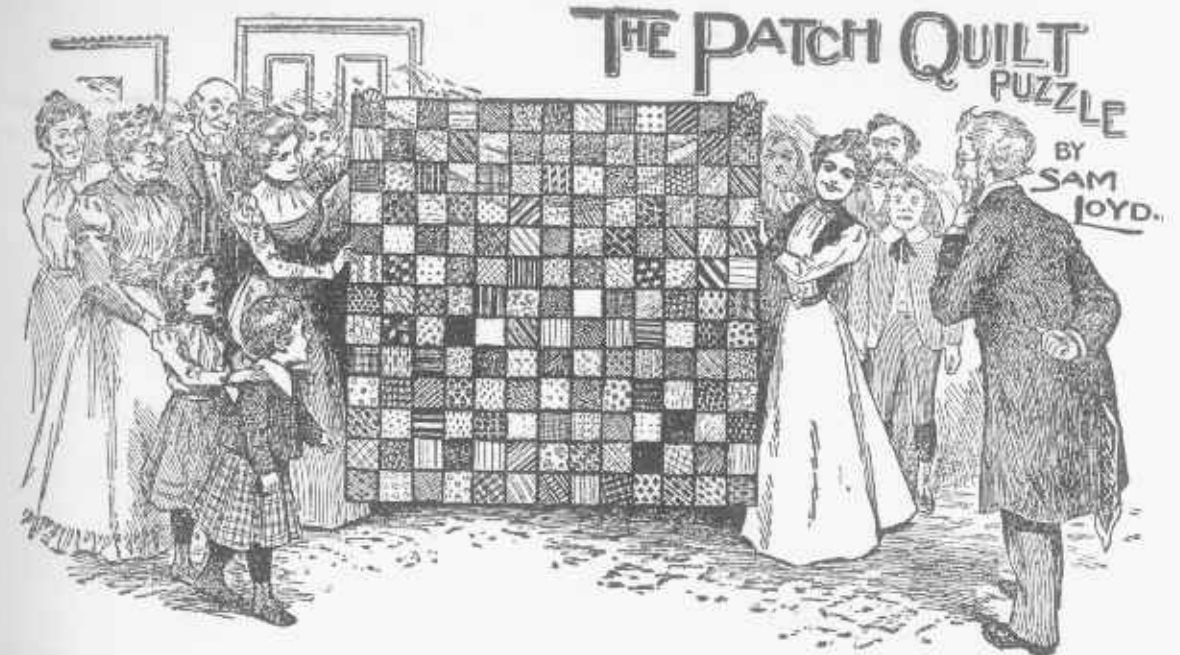

PROPOSITION—Into how few square pieces, containing one or more pieces of patchwork, can the quilt be divided?

SOMEWHAT IN THE nature of a rest from study, we will call attention to the Patch Quilt puzzle as being a companion piece to Mrs. Deacon White's remnant problem. The sketch represents the members of the "Willing Workers" society overwhelming their good parson with a token of love and esteem, in the shape of a beautiful patch work quilt. Every member contributed one square piece of patchwork consisting of one or more of the small squares, each of these contributions being perfectly square in shape, involved a pretty puzzle which nearly disrupted the society.

Any lady would have resigned if her particular piece of work was tampered with or omitted, so it became a matter of considerable study to find out how to unite all of the squares, of various sizes, together, so as to form the one large square quilt. Incidentally it may be mentioned that as every member contributed one square piece of patch quilt, you will know just how many members there were when you discover into how few square pieces the quilt can be divided. It is a simple puzzle which will give considerable scope for ingenuity and patience.

The Lost Cent.

Here is a puzzle known as the Covent Garden Problem, which ap-

peared in London half a century ago, accompanied by the somewhat surprising assertion that it had mystified the best mathematicians of England. The problem is continually cropping up, in some form or other, generally accompanied by that same statement of its having baffled the European mathematicians, all of which must be taken with a liberal allowance of salt, as our Yankee scholars would find such little difficulty in dispelling the mystery that I can only feel justified in presenting it as a special practice problem for our more juvenile puzzlists. As some of the other puzzles have proven to be too difficult for many beginners who have become interested in such matters, I have determined to act upon an oft-repeated suggestion from our younger friends to present a few simple problems of a mathematical nature which all should be able to solve.

Well, to get back to the Covent Garden Problem, which I had almost forgotten. It is told that two huckster ladies were selling apples at the market, when Mrs. Smith, for some reason or other which must be the real mystery which has baffled the mathematicians, was called away and asked Mrs. Jones, the other apple lady, to dispose of her stock for her.

Now, it appears that they each had an equal number of apples, but Mrs. Jones had larger fruit and was

selling hers at the rate of two for a penny, while Mrs. Smith sold three of hers for a penny. Upon accepting the responsibility of disposing her friend's stock, Mrs. Jones, wishing to be very impartial, mixed them all together and sold them off at the rate of five apples for two pence.

When Mrs. Smith returned the next day the apples had all been disposed of, but when they came to divide the proceeds they found that they were just seven pence short, and it is this shortage in the apple or financial market which has disturbed the mathematical equilibrium for such a long period.

Supposing that they divided the money equally, each taking one-half, the problem is to tell just how much money Mrs. Jones lost by the unfortunate partnership.

THE LOST CENT



A. B. C. Tea Party

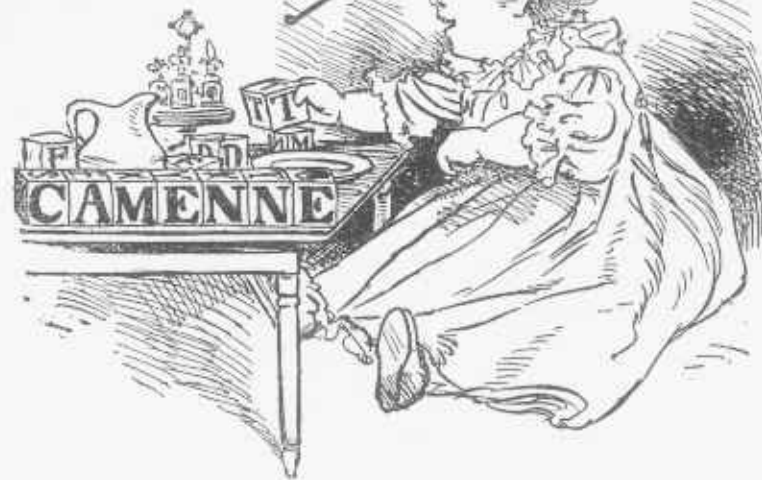

HERE IS A LITTLE tot's puzzle conundrum which will furnish food for reflection to the children of an older growth. Little Alice was playing tea party, but as all of her dolls had lost their heads and arms, so as not to be in a presentable condition, she was compelled to give the party to such remnants of her toys as she could muster, so, according to her vivid little imagination, she invited all of her A B C blocks to an afternoon tea.

She says that there was not places for all of them at the table, so half a dozen had to come later in the evening, which is very suggestive of a good prize conundrum. Why was it that the other letters were not present at the supper?

Then there is a pretty little spelling match connected with the puzzle which is also of interest. Can you change one of the blocks in the name, Camenne, and substitute some other letter so as to make it spell a correct word?

When is the soup likely to run out of the saucepan? When there's a leak in it.

What is it that from which the whole may be taken, and yet some will remain? The word wholesome.

Which is easier to spell—fiddle-dee or fiddle-de-dum? The former, because it is spelt with more e's.

What is that which is black, white and red all over, which shows some people to be green, and makes others look blue? A newspaper.

What is the best advice to give a justice of the peace? Peace.

A SWARM OF GOOD BEES



A SWARM OF GOOD BEES.

Here is a list of good resolutions for the New Year which a clever young miss has worked out in pictorial fashion upon a panel to be placed upon the wall, so as to catch one's eye upon rising in the morning. Figure them out so as to impress them upon the memory, as many of them are well worth keeping.

Who commits the greatest abominations: Nations.

Who is the greatest terrifier? Fire.

What is the best way of making a coat last? Make the trousers and waistcoat first.

If you drive a nail in a board and clinch it on the other side, why is it like a sick man? Because it is in firm.

After Dinner Tricks

BY SAM LOYD.

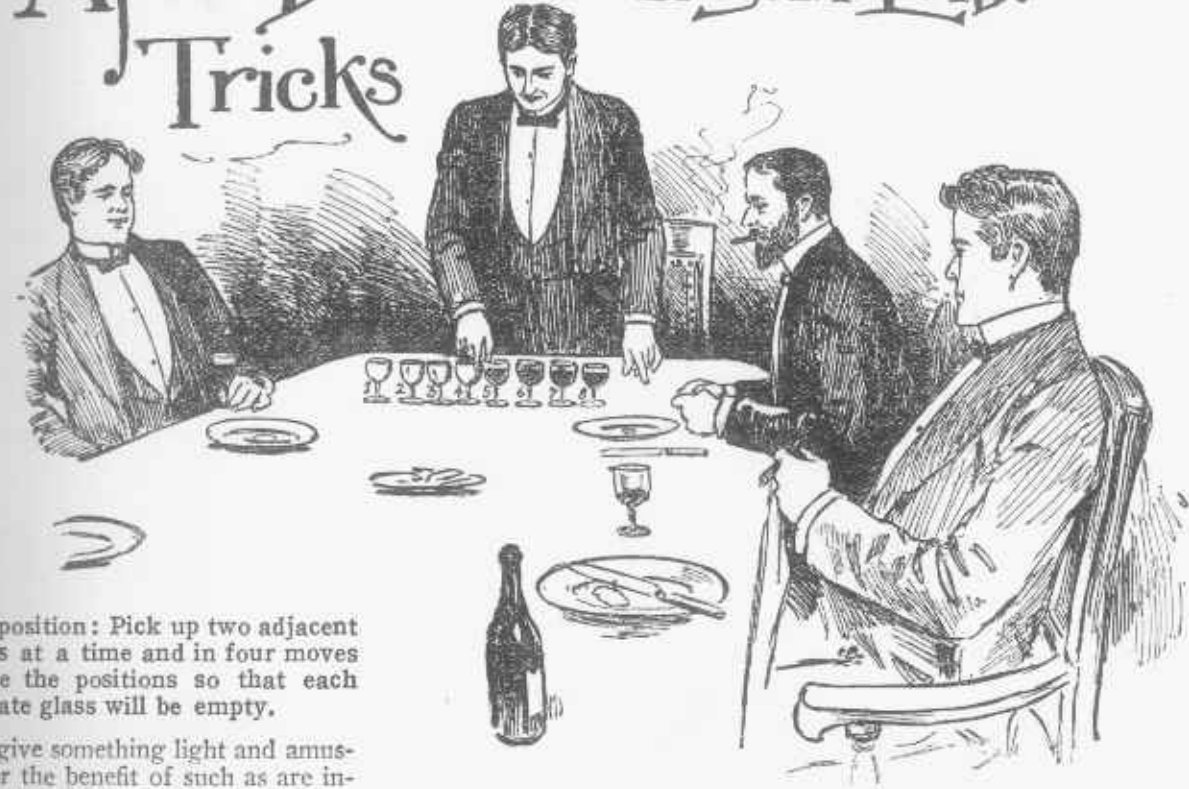

Proposition: Pick up two adjacent glasses at a time and in four moves change the positions so that each alternate glass will be empty.

To give something light and amusing for the benefit of such as are interested in tricks or what might be termed sleight-of-hand feats, I will give a puzzle which can be used advantageously to amuse the guests after a banquet or at an evening party. In the former case eight wine glasses—four empty and four partially filled—illustrate the trick to perfection.

In this, as in all exhibitions of a similar character, everything depends upon the skill and clever acting of the performer. He must have his little book down to perfection, so as to be able to do the trick forwards or backwards without the slightest hesitation, while by the aid of a ceaseless flow of conversation he impresses upon his hearers the fact of its being the most simple little trick that ever happened, which any one can do unless he be a natural born mutton-head or hopelessly befuddled. It really looks so simple, apparently working itself out correctly, no matter how or when the exhibitor commences, that almost any one will be lured into accepting an invitation to step up and test his sobriety by showing how readily he can perform the feat—and then the fun begins—for it will rattle ninety-nine out of a hundred.

To aid our young friends in describing their answers, the glasses are numbered, so that they can be referred to by numbers.

Decapitation Puzzle.

Now, if you wish,
Behead a fish,
"To listen" you'll discover;
Once more behead,
And find instead
A small close chest, or coffer.

One on Charlie.

"Say, Charlie, did you see the translation of Aguinaldo's cipher dispatch:

'BBBBBB
Do We
32541
27340

59971

Limburger Cheese.'

It has been found to read 'Sigsbee sent Dewey some Limburger cheese.'

"Why, it is awfully clever, isn't it?" replied Charlie. "But really I don't see just where they get the 'sent,' do you?"

"Why, the scent is in the cheese," replied his friend.

Animals Enigmatically Expressed.

1. To decline, and to declare.
2. Approached and an animal.
3. To gorge and a weight.
4. A rod and an animal.
5. To injure and a number.
6. A letter and a grain.
7. An insect and to run away.

A Numerical Enigma.

How strange a city this would be,
If we had not our 1, 2, 3;
But, in this wondrous 6, 7, 8,
Had learned the air to navigate,
Ourselves with 7, 6, 9 inflate
And skyward 4, 5, 9, 8!
Cipher Answer.—C. 1, 18, 9, 1, 7,
5, 19.

Comical Conundrums.

Who gave the tar-tar?
The jackall gave the Jack all.

Why did the wood-saw?
Because it saw the lamb-chop.

Why did the butter-fly?
Because it saw the cake-walk.

Why did the fly fly?
Because the spider spied her.

KLONDIKE YARNS

BY
SAM LOYD



S SHOWING HOW A puzzle may be extracted from anything, I am going to ask our young puzzlists to pass judgment upon the relative merits of three prize yarns which were spun in the Klondike.

It was during my last trip to the gold fields, when, in the company of some adventurous spirits, who, like myself, were in search of health, wealth and happiness under adverse circumstances, that we found ourselves huddled together in the main drawing-room of our domicile, patiently awaiting certain climatic changes which would soften up the ground so as to permit of its being scratched with a pick. We were all semi-professional men, which fact, I suppose, injected a certain spirit of rivalry into every discussion that was started. No matter how marvelous a story was told, it at once became the duty of the others to narrate a tale which, for daring improbability, should eclipse it. Veracity never was questioned; everything went, and the palm was yielded gracefully to the

one who told the biggest "whopper" which had the slightest semblance of probability.

I remember that the question of intelligence, or rather precociousness, in very young children had been under discussion, when one of the party remarked: "I never was so taken aback nor struck by the reasoning powers of a child as one day at dinner, when we were partaking of what we called soused pigs' feet. Harry, who was but three years old, had already eaten four pigs' knuckles, and was clamoring for more, when his mother said: 'I don't think you had better eat any more, Harry, or you will see the bogie man to-night.'"

"Now, mamma," replied Harry, after a moment of silent thought, "I may just as well settle the truth of that bogie story in my mind now and once for all; give me some more pigs' feet." So, from a purely investigating standpoint, he ate twice as many as he had before.

"Yes," said another member of the party, who was a civil engineer, "some children have precocious reasoning powers, for I remember

when Fanny was less than two years old, we took her to Niagara, and she made a calculation which proved how much water runs over the Falls in a month to an exact quart."

There was silence for a few moments, and it looked as if the engineer would retain the championship, but the doctor, who had a very slow and deliberate manner of speech, which added greatly to the impressiveness of what he might be telling, remarked: "Those are indeed remarkable stories, which go to prove the inheritance of mental power; but I recall a curious case which happened to me in Switzerland, which I have never been able to explain satisfactorily to myself. I was staying for the night at a little inn at Altdorp, when the host, who had probably heard of my reputation as a specialist, told me that one of his neighbors had a child which they feared was deaf and dumb. The parents had made all those little tests, such as clapping hands, etc., to attract the baby's notice, such as all mothers do, but without avail, and to relieve their minds the host asked me to examine the child's ears. I did so very thoroughly, and pronounced the case to be a hopeless one, wherein the child would grow up to be deaf and dumb.

"The parents, who were Swiss, did not speak a word of English, but asked through the host, who acted as interpreter, if something could not be done for the child.

"'Absolutely nothing,' I replied; 'the case is hopeless.'"

"To my utter astonishment the child, which was not yet six months old, looked up in my face with a sweet, infantile smile, and murmured: 'Absolutely nothing?'"

"It sounds incredible, I know, especially as the parents and every one else but mine host only spoke German; nevertheless, it is an actual fact."

Sometimes, after each of us had spun his yarn, there was a discussion as to which had told the best, and at times the competition was so close that it took considerable argument and some little force to settle the dispute. In a competition of the kind just mentioned it would be an easy matter to adjudicate, nevertheless, just as a lesson in logic, we will ask our young puzzlists to pick out the most remarkable of the three yarns, giving reasons for the preference.



PROPOSITION—Find the parts of a human being concealed among Santa Claus' presents.

SANTA CLAUS WISHES our puzzlists the compliments of the season and presents a puzzle which may be looked upon as a pictorial illustration of the famous riddle propounded by the Bishop of Oxford, wherein the parts of the human body were described. Santa Claus is the only complete person in view, but if you will carefully inspect and guess the correct names to each and all of his stock of presents it will be found to

contain an interesting and instructive lesson in human anatomy, accompanied by a chance to win one of the gifts which he proposes to divide among those who guess the best lists of the articles contained in his capacious sack. Of course, every one will see the palms and calf at a glance, but it is pretty safe to say that there are many things which are liable to be overlooked, so the aim is to see who can make the most complete list, even if everything is not discovered.

CHARADE.

Upon the check'd battle fie'd,
I'm foremost in the ranks;
My second makes a certain gain
Mongst railways, stocks and banks.
My whole thought sanctioned by the law
To succor the distress'd,
Is but, at least I think it so,
A doubtful good at best.
Cypher Ans. 16, 1, 23, 14, 2, 18,
15, 11, 5, 18.

A REBUS.

Curtail me, and I'm what you use
To do my whole, 'tis true,
And which I'm sure few will refuse,
Woe be to them who do!
Ans. 2, 18, 5, 1, 20, 8, 5 or 11, 14,
5, 5, 12.

CHARADE.

A troubadour from foreign lands,
To a lady fair came singing;
"O lady bright, from thine own true
knight
A message I am bringing:
He lies in the mountains near my
first,
He dares not come to thee;
The foe accurst would on him burst,
He therefore sendeth me.
And he biddeth me tell thee to seek
my next,
Where he will surely meet thee;
O! be not vexed, nor with fear perplex'd,
For thine own true love shall
greet thee."
Like a timid fawn, at early dawn,
To my second the lady hied;
And at his word, she met her lord,
Who had my whole supplied.
Cypher Ans. 16, 1, 19, 19, 16, 15,
18, 20.

A REBUS.

In yon vast field of cultivated space,
I there am found with members of
my race;
Decapitate me—if you've no objection—
You then will find what brings me
to perfection;
Take one more cut, and then you'll
plainly see,
What I am destined, day by day,
to be.
Cypher Ans. 23, 8, 5, 1, 20.

Why is a leaf of a tree like the human body? Because it has veins in it.

What is that which is lengthened by being cut at both ends? A ditch.

LEWIS CARROLL'S MONKEY PUZZLE



PROPOSITION—What will be the result if the monkey attempts to climb the rope? Will the weight rise or fall?

HERE IS A QUAINLY told problem in mechanics, which, despite its apparent simplicity, is said to have caused Lewis Carroll considerable disquietude. Whether the famous author of "Alice in Wonderland," who was an Oxford professor of mathematics was the originator of the problem is not known, but in an evil hour, as mentioned in a recent paper upon his writings and doings, he asked for information upon the following subject:

"If, to a rope, passed over a loose pulley, is suspended a ten-pound counter weight, which balances exactly with a monkey eating an apple, swinging at the other end, what would be the result if the monkey attempts to climb the rope?"

"It is very curious," says Lewis Carroll, "to note the different views

taken by good mathematicians. Price says the weight goes up with increasing velocity. Both Clifton and Harcourt maintain that the weight goes up at the same rate of speed as the monkey; while Sampson says that it goes down."

A distinguished mechanical engineer says "it would have no more effect than a fly crawling up a rope," while a scientist claims that "the weight would rise or lower, according to the inverse ratio of the speed with which the monkey ate the apple," from which, however, should be extracted the square root of the monkey's tail. Seriously speaking, it is a pretty problem, and, as the principle of Lewis Carroll's monkey puzzle has become a much-discussed problem, worthy of serious consideration, it is presented to illustrate the intimate relationship between puzzles and mechanical problems.

It is a well-known fact that the study of puzzles of any kind gives one a clear insight into the principles of mechanical laws or natural philosophy.

In theory the problem appears to be about as paradoxical as a recent conundrum which is going the rounds as to what is it that will go up a chimney down or down a chimney down, but will not go up a chimney up nor down a chimney up? (An umbrella.)

For Bible-Students.

If the children slain in Herod's Slaughter of the Innocents were buried in sand with but the right foot showing, how could you tell the girls from the boys?

This has puzzled many theologians, but the answer is simple: Only boys were slaughtered!

A Five Minutes Talk on Chemistry.

Without burdening the memory with technical nomenclature I wish to say a few words about chemistry for the benefit of the public at large and the student who may be interested in pursuing the subject further.

We learn from the text books that organic chemistry treats of things which have organs to breathe, eat, and grow, like animals and vegetables, while inorganic chemistry pertains to rocks, metals, gases, etc. According to the atomic theory there are 71 original elements which go into the makeup of everything. These elements consist of infinitesimally small atoms which combine with other atoms to make flesh, bone, wood, coal, water, air, acids and everything that exists. Here are the 71 elements:

NAME	Sym.	Atomic Weights.	NAME	Sym.	Atomic Weights.
Aluminum	Al.	27.3	Molybdenum	Mo.	96.
Antimony	Sb.	120.	Nickel	Ni.	58.
Arsenic	As.	75.	Nitrogen	N.	14.
Barium	Ba.	137.	Osmium	Os.	198.6
Beryllium	Be.	9.	Oxygen	O.	16.
Bismuth	Bi.	208.	Palladium	Pd.	106.
Boron	B.	11.	Phosphorus	P.	31.
Bromine	Br.	80.	Platinum	Pt.	195.
Cadmium	Cd.	112.	Radium	Ra.	226
Cesium	Cs.	133.	Rhodium	Rh.	104.
Calcium	Ca.	40.	Ruthenium	Ru.	101.3
Carbon	C.	12.	Rutherfordium	Rf.	261
Cerium	Ce.	140.	Samarium	Sm.	150.
Chlorine	Cl.	35.5	Scandium	Sc.	44.
Chromium	Cr.	52.	Selenium	Se.	79.
Cobalt	Co.	59.	Silicon	Si.	28.
Columbium	Cb.	94.	Silver	Ag.	108.
Copper	Cu.	63.5	Sodium	Na.	23.
Deuterium	Dp.	2.	Strontium	St.	87.5
Dysprosium	Dy.	162.5	Sulphur	S.	32.
Erbium	Er.	167.	Tantalum	Ta.	182.
Fluorine	F.	19.	Tellurium	Te.	128.
Gallium	Ga.	69.	Terbium	Tb.	159.
Germanium	Ge.	72.6	Thallium	Tl.	204.
Gold	Au.	197.	Thorium	Th.	232.
Hydrogen	H.	1.	Thulium	Tm.	169.
Indium	In.	114.8	Tin	Sn.	119.
Iodine	I.	127.	Titanium	Ti.	48.
Iridium	Ir.	193.	Tungsten	W.	184.
Iron	Fe.	56.	Uranium	U.	238.
Lanthanum	La.	139.	Vanadium	V.	51.
Lead	Pb.	207.	Ytterbium	Yb.	173.
Lithium	Li.	7.	Yttrium	Yt.	89.
Magnesium	Mg.	24.	Zinc	Zn.	65.
Manganese	Mn.	55.	Zirconium	Zr.	90.
Mercury	Hg.	200.			

It will be seen that each of the elements has its chemical symbol and atomic number. These atoms will combine with other atoms to produce acids, salts, bases or compounds only in multiples of those numbers. Hydrogen (H) is the lightest of all known substances and is therefore designated as 1. It is fourteen times as light as air, from which we might readily estimate its usefulness for ballooning.

Oxygen (O) being 16 times as heavy as H has 16 for its atomic number and unites with other elements in proportions of 16, 32, 48, 64, etc. In uniting these elements to

form compounds, numbers are placed after the symbols as in algebra, to indicate the 2nd, 3rd, or 4th powers. Just as we get a clear idea of the work in a mathematical expression like $A^2 + B^3 - XY = Z$, the chemist describes his formula in symbols like $HCl + NaHO = NaCl + H^2O$ which produces salt water, or $C^3H^5 (ONO)^3$ which is the formula for nitroglycerine which Hudson Maxim, the great authority on explosives, gave me the other day.

Here are some of the combinations for acids, which you will notice, all contain hydrogen:

- Nitric acid NHO^3 .
- Hydrochloric acid HCl .
- Sulphuric acid H^2SO^4 .
- Hydroiodic acid HI .
- Phosphoric acid H^3PO^4 .
- Hydrobromic acid HBr .

Then we get the different salts by putting metals in the acids in place of H, as well as hydrates and bases which pertain to the chemical nomenclature.

The different multiples of an element will produce entirely dissimilar compounds. H^2O is the formula for water and indicates that two atoms of H to one atom of O form water, O being 16 times heavier than H show that H forms the 9th part of water. Now increase the proportion of O and what was a tasteless liquid becomes a thick, syrupy compound with a bitter taste and disagreeable odor which will not freeze by intense cold. No use has yet been discovered for this curious compound.

Air consists of one-fifth oxygen to four-fifths nitrogen, and yet five dissimilar compounds result from their combinations: Nitrous oxide (laughing gas) is N^2O . Nitric oxide is NO . Nitrous anhydride is N^2O^2 . Nitrogen peroxide is NO^2 , and nitric anhydride is N^2O^5 .

Anything may be decomposed, burned or changed by chemical action but nothing is destroyed, every atom can be accounted for and restored. It is somewhat akin to Sir Walter Raleigh's wager that he could weigh the smoke from his tobacco. He carefully preserved and weighed the ashes from his cigars, which, deducted from the original weight of the tobacco, showed exactly how much had escaped in smoke.

Broadly speaking there are two principles in chemistry: Analysis,

which analyzes or dissects a compound to discern its ingredients; and synthesis which combines the elements to form other compounds. The modern chemist knows intelligently which of nature's products contain the elements required to produce a new combination and in separating them will save the other elements and form valuable bi-products.

It requires but little knowledge of chemistry to realize how blindly the old alchemists were groping in the dark, or how absurd are the popular stories of great chemical discoveries having been hit upon by accident.

Nothing explains the principles of analysis better than the little game of questions, which I heartily recommend to my young friends. Think of any thing and I will guess it in fifteen questions to which you need reply but "yes" or "no." All right, you have thought of "a sticker," have you? Well, does it belong to the animal kingdom? "No." That's good, there are already 10,000 things which I know it is not. Does it belong to the vegetable kingdom? "No." Good, now there are a whole lot of things I know it isn't, and I know it belongs to the mineral kingdom, so I ask at once, is it metal? "Yes!" Is it sold at the hardware store? "Yes." Is it a kind of tool? "Yes." Does it have to be sharpened? "No." That was a foolish question, but I was wasting no time, so I will lump a lot of queries. Now listen. Is it one of the following articles: A fire shovel, spoon, poker, stove lifter, cake turner, hammer, cork screw, or pincers? "Yes!" Hurrah, it is one of eight, and you can reduce eight to one in three questions, so I get it in ten queries. Ingenious people may originate clever questions which eliminate thousands of articles, just as the chemist eliminates and proves more by what there is not, than by what there is. It reminds me of what a little boy wrote about salt. "It is something that makes our taters and things taste orful bad when there isn't any."

The clever reader will see that this principle is well illustrated in this little lecture on chemistry: no rules or formulas being given you are expected to draw all information you can from the lessons which are not given!



Proposition: Divide the Greek Cross into three pieces which will fit together and form a rectangular oblong.

To illustrate the principle of working a puzzle backward, according to the axiom that a good rule should work both ways, we introduce a reasonable problem wherein the object is to discover how to divide a cross into three pieces which can be fitted together so as to form a rectangle which is twice as long as it is wide. This, of course, is merely reversing the proposition of converting a rectangle or square into the form of a Greek cross, but, in that it presents the angles which must be fitted together, is not so difficult as the other proposition.

The Swastica Sign

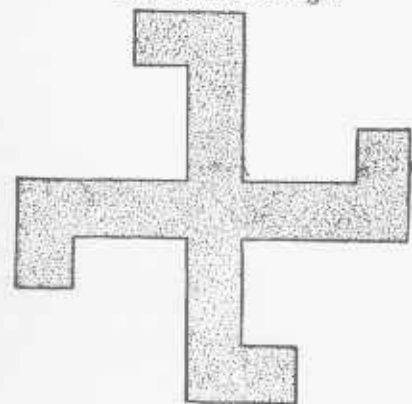

Cut into five pieces which will form a square.

Here we have the ancient Swastica symbol, which, as set forth by Prof. Wilson of the Smithsonian Institute of Washington, in a great work with some five hundred illustrations from the Aztec mounds of Mexico, the pyramids of Egypt, the ruins of Troy and of Chinese and Indian lore, was one of the oldest signs of the human race to be traced through prehistoric ages.

It is the sign of "luck to you," after the manner of the modern horseshoe, and is found on ancient temples, ruins and monuments in a way that leaves no room for doubt as to its correct interpretation, although the same can be traced for three thousand years as the Hammer of Thor, known in Masonry as the Master's mallet, emblematical of power and decision. Again we find it described in dusty old manuscripts as the fylfot, or four-footed, where it is shown as four legs branching out from the center. It is only a variation of the Monad sign, and in this form is known in China as "wan," meaning "many long years to you." Prof. Max Muller says the sign is found in ancient ruins and in excavations in every part of the globe, and must have been universally recognized. Is it a mere coincidence,

or is it the discovery of a mystic secret, that we find when we take the emblem of the square and mark the sign of the Swastica in the center, that the four parts will form a perfect Greek cross, and if we mark it with the double Swastica, which was another ancient symbol, the four quarters will form two crosses! Theologians might involve a startling interpretation from these mysterious transpositions.



"I say, Alice, I just thought of an original conundrum," said Charley, who thought he was getting on to a solid footing with Miss Lofty.

"Why is the moon like a suit of clothes?"

"Mr. Lightop," replied the offended maiden, "I presume you claim that there is a man in both, but opinions might differ on that subject." And Charley felt the sand slipping away from under his feet



I heard a man boasting the other day about his horsemanship, and among other things told how he had refused all assistance in subduing a vicious horse which failed to throw him from the saddle. Shortly afterwards I met a friend who had witnessed the feat of the bold rider, and who gave me such a humorous description of the incident that it struck me as being worthy of illustration in puzzle form. See if you can find the locality of the accident concealed in the description of the picture.

A Charade.

In finding my first don't be long,
And yet not so long for my second;
My whole affects him at the bar,
To whom little profit is recovered.

Cipher Answer.—2, 18, 9, 5, 6, 12, 5, 19, 19.

A Curious Calculation.

When the Great Eastern was launched and was attracting attention from its great size, a mathematically inclined lunatic who had been in the pin business discovered that if a pin were dropped into the hold of the Great Eastern, and on that day week a second pin, and on that day week four pins, and so on, doubling the number of pins each week, for a year, there would be at the end of fifty-two weeks, deposited no fewer than 4,503,599,627,370,495 pins. Allowing 200 to the ounce, the weight of the whole would be 628,292,358 tons, and to carry them all would require 27,924 ships as large as the Great Eastern, which was calculated to hold 22,500 tons.

A Rebus.

I'm of little importance, so off with my head;
To a foe I might then be the terror and dread.
Decapitate twice, and reverse what remains.



A Dutchman with a goat and a goose met a milkmaid leading a cow, whereupon the maiden screamed with terror.

"What frightens you?" asked Hans.

"You are going to kiss me against my will," said the coy maid.

"How can I do that with these cranky animals on my hands?" asked Hans.

"What prevents you from thrusting your cane into the ground so as to fasten the goat to it and then put your goose under my pail?" queried the maiden.

"Because that cross-looking cow might hook me," said Hans.

"Oh, that fool cow wouldn't hook nobody, and what is to prevent you

And lol you've a wandering sprite for your pains.
Cipher Answer.—20, 18, 9, 6, 12, 5.

Anagram Puzzle.

Make one word with the letters nine thumps.

Numerical Enigma.

1, 17, 5, 6, 7, an opera.
9, 18, 19, a woman's care.
15, 14, 10, 12, 16, a bone.
5, 2, 18, 12, a relative.
13, 11, 18, a recluse.
My whole is one of Shakespeare's plays.

Some Evolution Puzzles.

In how few changes can you convert *lands* into *hills* substituting one letter at a time and always forming perfect words?

Convert *shoe* into *boot* in three one-letter changes, always forming perfect words.

Convert *beer* into *wine* in five changes, substituting one letter at a time, always forming perfect words.

In how few changes can *north* be converted into *south*, changing only one letter at a time, always forming perfect words?

from driving all three of them into my pasture field?" replied the terrified maiden. And right here comes the most interesting puzzle of the series which has yet been presented to our friends; for during the subsequent discussion the following facts developed: They found that the goat and the goose together would eat just as much grass as the cow, so if that field would pasture the cow and the goat for forty-five days, or the cow and the goose sixty days, or the goat and the goose for ninety days, how long would it pasture the cow, the goat and the goose? Early replies are requested, as Hans and Katrina are contemplating a speedy partnership.



WILL TAKE occasion to remark that the fact of some of my puzzles being well known does not imply that every one is familiar with the answers to them, for the correct answers to some of the most popular ones have never been published, and, so far as I am aware, have never really been guessed. I will illustrate this point by presenting as a reasonable problem the "Necklace Puzzle," which I showed several years ago, and which every one who sees it flatters himself that he solves it at once, and yet I do not remember any one who really found the correct answer.

It is based on an everyday business transaction, intended to show how the average mortal goes the wrong

way about doing anything which calls for the slightest mechanical knowledge or ability. It is devoid of all semblance of catch or subterfuge, and there is no "missing link" mystery about it, and it is intended to be governed by the ordinary business methods, and yet it was given to all of the leading jewelers and chain makers of New York, who said they would have no use for a salesman or employee who could not see through such a simple transaction, and yet not one of them gave the correct answer.

A lady bought twelve pieces of chain, as shown in the border of the picture, and wished to have them made into an endless necklace of 100 links, as held in her hands.

The jeweler said it would cost 15

cents each to cut and join a small link and 20 cents to joint and cut a large link, and the question is to tell just how much the lady should pay to have the necklace made? That is all there is to it, and it is a pretty problem for the young folks.

A Charade.

Two personal pronouns, if you take
And join them in due order,
An herb will name without mistake,
That scents the garden border.
Cipher Answer.—20, 8, 25, 13, 5.

A Rebus.

Entire I am capital; curtain me
and I am capital still; but behead and
transpose me and I am looking for
capital.

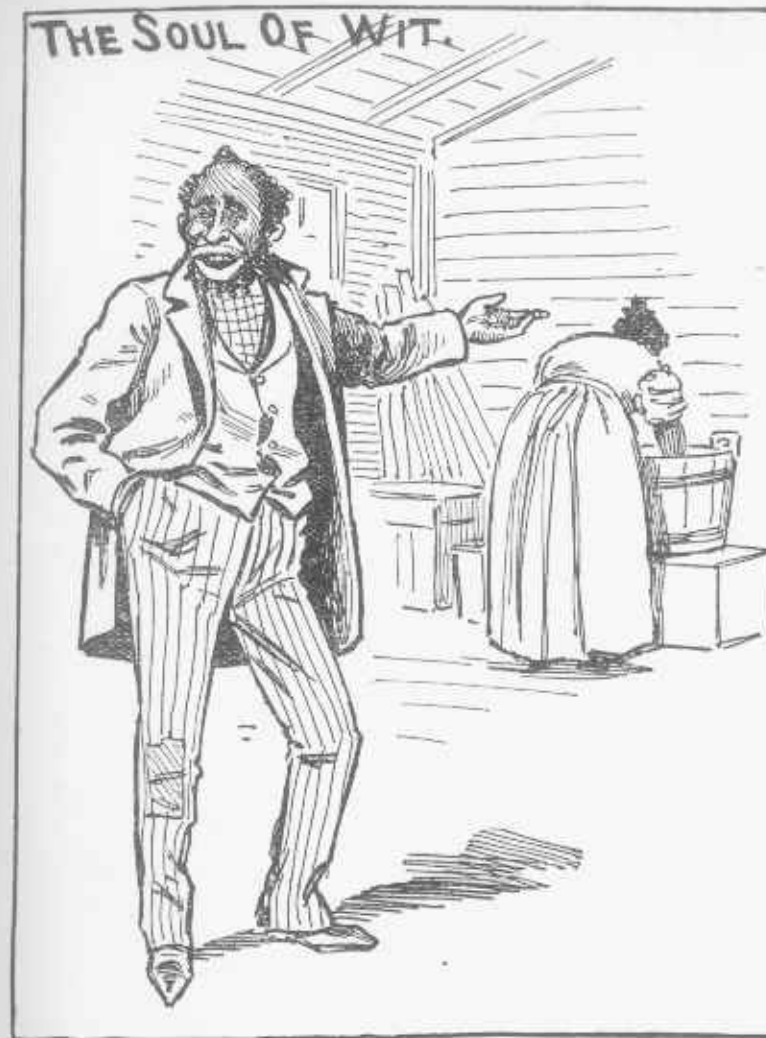

This little conundrum is built upon the following incident from real life:

"Dere am no circumlocation nor wasted breff 'bout-dat wife of mine when she am in de humor to be brief," soliloquized Mr. Washington Johnsing when he came home a few hours late for the evening meal and found the larder as empty as his stomach.

"What time am it, and war am de cold chicking?" he asked in an introductory way as a sort of feeler. Two questions which naturally called for two replies, but Mrs. Johnsing was not in the humor for protracted conversation, so without discontinuing the little ballad of

"The bee what gits de honey,
Don't hang 'round de hive"

she merely paused to vouchsafe one brief answer, which covered both subjects, and Mr. Johnsing, who read the signs of a rising family barometer, surmised that it would be diplomatic to make himself scarce.

It was neither given nor intended by Mr. Johnsing as a conundrum, but that our readers may be en

rapport with Darktown sassiety events, we present it in puzzle form for our young folks to study over, to see if they can discover the briefest possible answer to Mr. Johnsing's two queries.



A lady bought a bouquet at the florists for thirty-four cents and had a one dollar bill, a three cent piece and a two cent piece. The florist had but two coins in the till, and therefore could not make the change. A bright newsboy came in who had two ten cent pieces, a five, a two and a one cent piece, who showed them how to clear the financial situation so that every one was left with their correct amount of change. How did they manage to do it?

This occurred in the old days when two and three cent pieces were in vogue. The boy has since grown to manhood, and is the cashier of the largest banking institution in the United States.



Hipity-Hop, the lame peddler, says, that he went up a hill at the rate of one and a half miles per hour and came down at the rate of four

and a half miles per hour, so that it took him just six hours to make the round trip. Can you tell how far it was to the top of the hill?

THE WEIGHT OF A BRICK



Here is a little puzzle designed to illustrate the principle of cancellation as applied in algebra to discover an unknown weight from a fractional part of itself. As these kindergarten illustrations are given to instruct beginners in the rudimentary principles of algebra, and not for the purpose of puzzling them, we present the explanation with the picture before them.

Algebra teaches us that the balance is not affected by removing similar quantities from both sides of an equation, so, in this puzzling little proposition we remove three-quarters of the whole brick and cancel off the three-quarter bat. This leaves the weight balancing with one-quarter of a brick; therefore if one quarter of a brick weighs three-quarters of a pound, a whole brick weighs three pounds. It suggests a possible solution to Uncle Jake's problem of the goose which weighed seven pounds and five-sevenths of its own weight. But then the goose always said there was no answer to the problem.

We almost lose veneration for the big fish story which for several centuries has been the terror of every graduating scholar. The head of the fish was nine feet long, the body as long as the head and tail together, and the tail as long as the head and half of the body. The head being a known quantity we find the length of the body to be 9 plus half of the tail. The tail therefore equals 9 (the head) and half of 9 ($4\frac{1}{2}$) which makes $13\frac{1}{2}$ added to half of itself. Here is where the resemblance to the

brick problem comes in. The tail is $13\frac{1}{2}$ feet long and half of itself. If one half equals $13\frac{1}{2}$, both halves equals 27 feet. Thus we have the length of the tail as 27 feet, and the body 36 feet, so 9 plus 36 plus 27 shows that Baron Muncausen must have landed a 72 foot fish, and he caught it with a hook.

A Rebus

My first is a preposition.
My second implies more than one.
My third is a pronoun.
My fourth some people never pay.
My whole is not consistent.
Cipher Answer.—9, 14, 3, 15, 8, 5, 18, 5, 14, 20.



It was told that two lads, each with the same amount of cash, played the races upon Lord Rosslyn's system of placing as many dollars upon the poorest horse as they offer odds of so many dollars against a single dollar. Jim backed "Kohinoor" to win straight, while Jack bet on him for second place,

so they put up different amounts at different odds, although the amount of their bets together was equal to half of their combined capital. They both won, but when they cashed their winnings and counted their capital, Jim had twice as much money as Jack. Now, who can guess the amounts won?

A Rebus

My first in pageant grand oft forms a part,
My second is the darling of your heart;
My whole within your parlor may be seen,
Where, safe to say, my second oft has been.
Cipher Answer.—3, 1, 18, 16, 5, 20.

A Charade

My first presents an honored female name,
But lovingly abbreviated;
My next a man's, and treated just the same,
Now, if this couple were only mated,
And to the altar duly led,
To be my whole which might be said.

A Rebus

Though of my first the quack may boast,
My next he cannot cure;
Who do my whole along the coast
Should punishment endure.
Cipher Answer.—16, 9, 12, 12, 1, 7, 5.

A Rebus

My first, dear ladies, you will find,
Is of my second made;
My whole with pleasure is designed
Upon my first to wait.
Cipher Answer.—2, 18, 9, 4, 5, 19, 13, 1, 9, 4.



EVERYONE is familiar with the time-honored puzzle of the ship's carpenter who had to patch a square hole by cutting a 9×16 bit of wood into two pieces. It forms a valuable and interesting lesson in puzzle-making which is well worth knowing as it will enable you to originate or readily solve other puzzles of that class.

Oblongs of any desired proportions may be formed by measuring off the side of a square into a given number of spaces; then marking off the base so as to contain one space less, so they will be greater in width than height. Then mark the square and cut down on the steps as shown, and

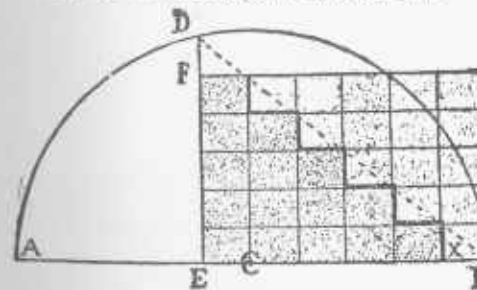

the two pieces form patterns for new puzzles to be divided into two pieces to be made into squares. Here is the carpenter and below him the two boards that make two squares.

In solving puzzles of this kind the dimensions of the required square

can be obtained by multiplying the side by the base, which, as in the case of the carpenter's puzzle: 9×16 , and 4×9 , or 8×12.5 will always produce a square number. By the puzzle process of working backward, we see that the base of the oblong must be divided off into a certain number of spaces, slightly larger, and containing one more space than the side to make the steps form a perfect square.

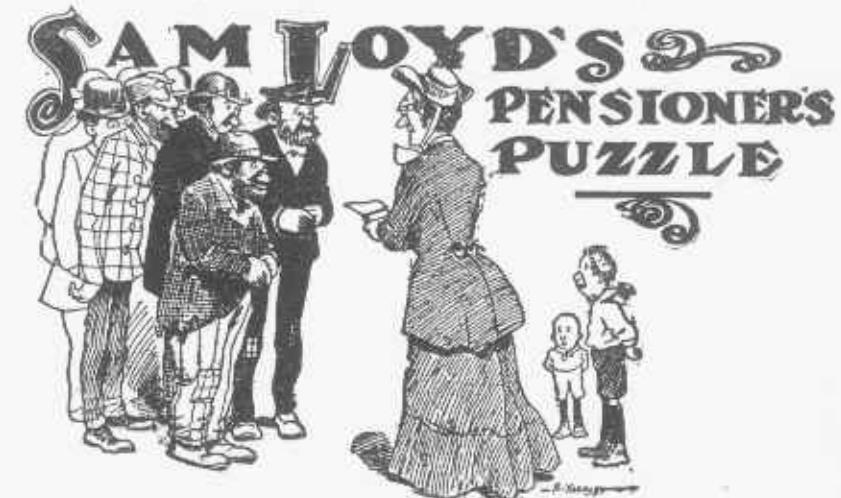

A kind lady who dispensed charity every week to some needy persons hinted to her pensioners that each would receive two shillings more if there were five applicants less. Each mendicant endeavored to persuade

It is easy to guess the number of spaces for the side and base, but to reduce the problem to an exact science, it is well to apply the following rule for squaring rectangles:

To the length of any rectangle add the width, so as to obtain the distance A to B, then with a pair of compasses placed at the center C, describe the semicircle B A. The intersection of the arc with the line from E to D gives the correct size of the square to be built from the rectangle. The distance from D to F shows the size of the spaces to be represented on the side of the rectangle, so we find in this case it will measure five of such spaces, and as the base must contain one more space, we divide it off into six. The difference in length between E to B and E to D would represent the width of the required spaces on the base line. The above formula solves any rectangle that was built from a square by the carpentering process, but the Euclidian rule which performs the feat in three pieces from any rectangle is to cut on the dotted lines—on the bias—from B to D; slide up the top piece and clip off the little corner X to patch with. It is a beautiful rule with which all puzzlists should be familiar, so now that you understand the principle, can you square the two illustrations given?

the others to keep away. Nevertheless, at the next meeting every one was on hand, and four new applicants, so that every one got one shilling less.

Can you tell how much each one received?

MILKMAN'S PUZZLE



There are practical problems in all trades, so it is safe to say that no one is an adept at his business unless he has picked up a few wrinkles which pertain to his calling. Honest John says that what he "don't know about milk is scarcely worth mentioning," but he was nearly flabbergasted once when he had nothing but two ten gallon cans full of milk, and two customers with a five and a four quart measure wanted two quarts put into each measure.

It is a juggling trick pure and simple, devoid of trick or device, but it calls for much cleverness to get two exact quarts of milk into those measures employing no receptacles of any kind except the two measures and the two full cans. You can try the problem with the fullest assurance that it is a legitimate proposition and not a silly catch.

A Charade

My first is one, or many men;
My second comes apace;
My whole's a pledge to be redeemed
Within a certain space.
Cipher Answer.—8, 15, 19, 20, 1, 7, 5.

A CRYPTOGRAM.

U R A 1 0 0 5 0 0 5 5 N.

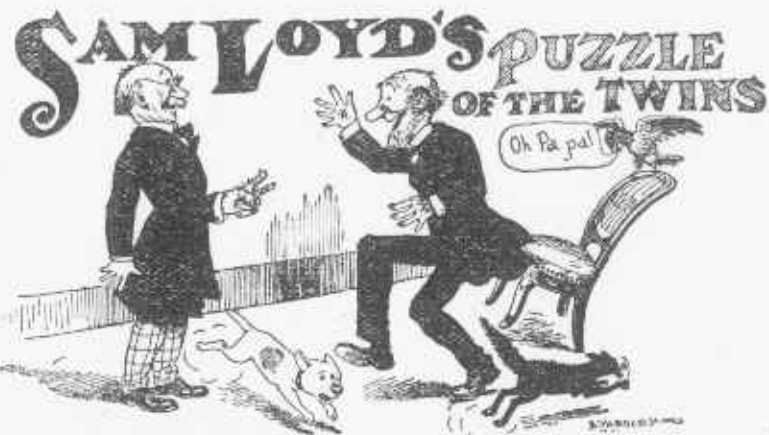

In the exuberance of his joy at the prospect of becoming a happy father in his old age, O'Shaugnessy vowed to settle two-thirds of his estate upon "the boy" and one-third upon the mother, but in case "the boy" should be a girl, then two-thirds of the estate should go to the mother and one-third to the daughter; when it developed, however, that the boy

was a twin, which made it necessary to provide for both a boy and a girl, as well as the mother, O'Shaugnessy's mind was not in a state to decide upon the proper way to carry out the terms of his promise. What do our friends, especially the members of the legal profession, who have shown so much interest in these problems, say should be the proper division of O'Shaugnessy's estate?

A Rebus

My first is found in the ocean wave,
As well as in the pit and the mine;
My second below the surface we have
Where never the sun can shine.
My whole the festal board to grace,
But seldom fails to find a place.

Cipher Answer.—19, 1, 12, 20, 3, 5, 12, 12, 1, 18.

A Rebus

Within my first you gallant crew
An anchor safe may find;
My next, ye fair, indeed, 'tis true,
Without an end may bind.
Without my whole we're surely lost,
Midst wintry blasts and biting frost.

Cipher Answer.—3, 15, 22, 5, 18, 9, 14, 7.

A Charade

When Kate the cook prepared the meal,
My first was in request;
My next is seen in lamb and veal,
A quarter or a breast—
Which with my whole the table graced,
And truly 'twas no wonder,
When at the board each guest was placed,
To see my third thrown under.

A PUZZLE IN OIL AND VINEGAR



"I started in business with an odd lot of oil and vinegar," said a shrewd speculator. "My first customer bought \$14 worth of each, paying twice as much for oil as for vinegar per gallon, and left me but one barrel. Now, see if you can guess what that barrel was worth?"

A Rebus

The limits of my whole to scan
Is far beyond the reach of man;
Behold it and a journey take,
To prove what progress you can make;
Transpose, with rocky sides and steep
I brave the fury of the deep.

Cipher Answer.—19, 16, 1, 3, 5.

A Charade.

Suppose that half a dozen of us
Were on a mountain placed;
The prospect thence, without my whole,
Would darkness seem, and waste.
Cipher Answer.—22, 9; 19, 9, 15, 14.

Does any word contain all the vowels? Unquestionably.

A Charade.

My first—yes, I'll straightway confess it—
'Tis a hundred to one if you guess it.
But what shall I say of my second?
Just half of a title 'tis reckoned.
My third has a personal status,
A lady, indeed, may await us.
"Good for naught," without aid or abettors,
My whole is made up of odd letters.

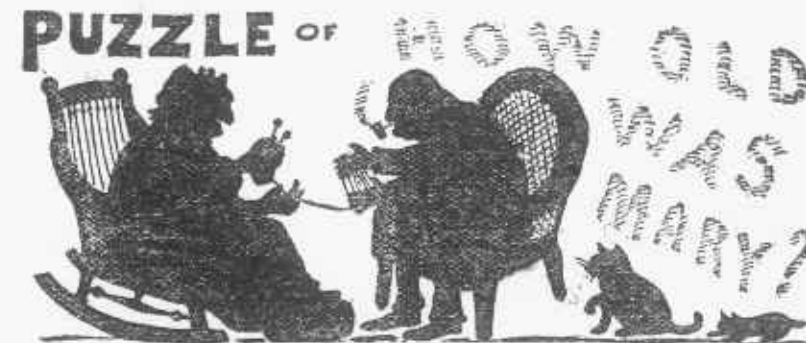

As a companion piece to my problem of "How old was Ann?" and, by way of apology to Sister Mary, who was slighted or ignored in the public controversy of the question, we present a sketch of the reminiscent old couple who were responsible for the discussion: "You see,"

The Hammock Puzzle.

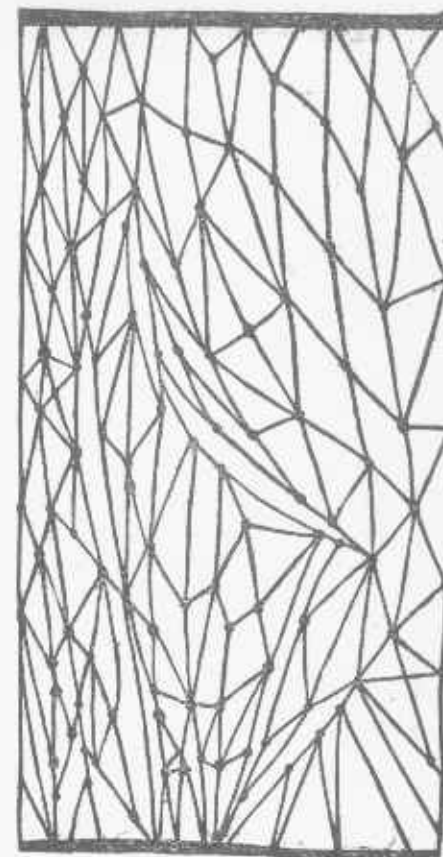

Miss Carrie Wait broke her hammock, which was suspended between two trees. On the well known axiom that a chain is no stronger than its weakest link, she says that you can readily tell her weight by finding the least number of cords you would have to cut to divide the hammock in two pieces. She says that a cord will hold exactly ten pounds. Then how much did Miss Carrie weigh?

remarked Grandpop, "the combined ages of Mary and Ann are 44 years, and Mary is twice as old as Ann was when Mary was half as old as Ann will be when Ann is three times as old as Mary was when Mary was three times as old as Ann." How old is Mary?

THE PATROLMAN'S PUZZLE

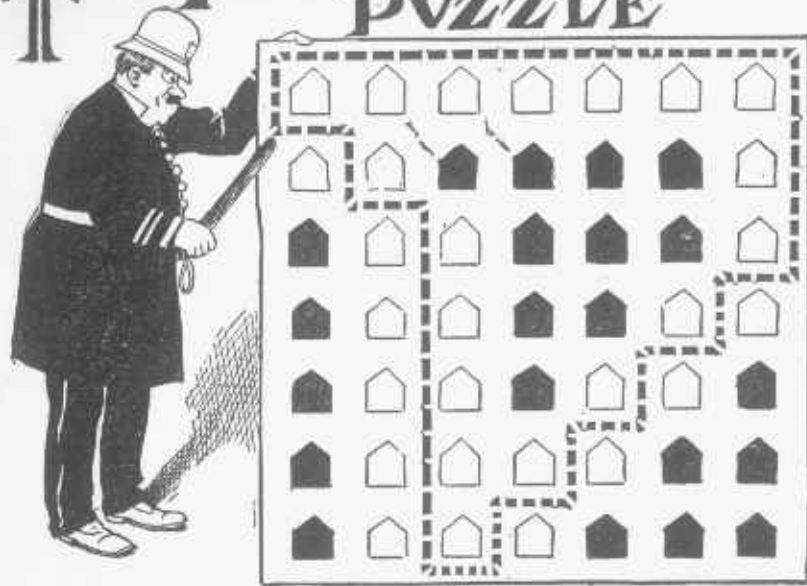

HERE'S a problem which has been puzzling Clancy ever since he got on the force. He has made a diagram of the situation and asks for the assistance of our clever puzzlists. He patrols seven blocks of the eighth ward, beginning and ending his nightly tour from the point he is indicating at the corner of Avenue A and Second Street. His orders are to patrol an uneven number of blocks on each street and avenue, so, as shown by the route, he goes either one, three, five or seven blocks before he turns. He knows all the servant girls in the houses he passes and some of them he says are right smart and pert, but before he selects a wife he would like to extend his route so as to discover a dark eyed beauty named Maggie Murphy, who he thinks lives in one of the houses off of his beat. You see he only passes those white houses and he wishes to find a route which complies to the regulations about only going an odd number of blocks on each avenue and street but will take him past the greatest possible number of houses.

Now, see if you can aid Clancy in the search for Maggie Murphy's home.

A Charade

Behead something irritating and leave something soothing.

Cipher Answer.—20, 5, 1, 19, 9, 14, 7.

A Charade.

My first is a creature of wonderful form;
My second gives shelter in sunshine and storm;
The empire of Flora embraces my whole,
Entire you may find me where seabillows roll.

A Rebus.

Whether backwards or forwards I'm read,
Matters to me not a bit;
I am gentle and light, and transposed
Am ever ready and fit.



While discussing the problem of squaring an oblong, let us tell of a practical experience which befell our little friend Bo-Peep.

According to authorities on Mother Goose the carpenter who constructed the sheepfold for Miss Bo-Peep discovered that he could save

A Charade
Aristides had, of Grecian fame,
My first appended to his name!
Where Boreas reigns my next is found,
Immersed in ocean's depths profound;
My whole the balance rightly scans,
And baffles Fraud's unhallowed plans!
Cipher Answer.—10, 21, 19, 20, 9, 3, 5.

A Rebus

Four letters form me quite complete,
As all who breathe do show;
Reversed, you'll find I am the seat
Of infamy and woe,
Transposed once more, I oft am seen mean,
My name betrays my race;
Transposed once more, I ofte am seen
To hide a lovely face.
Cipher Answer.—12, 9, 22, 5.

A Charade.

Enchain my vile first for the general weal,
That a nation's sad wounds may have leisure to heal;
Encage my fierce next, but he springs from his lair,
And gives thee for combat no time to prepare;
Suppress my dire whole, lest, before thy shocked gaze
Each smouldering spark burst into a blaze.
Cipher Answer.—18, 5, 2, 12, 12, 9, 15, 14.

two posts by making the fold square instead of oblong. "Either way would hold the same number of sheep," said the clever mechanic, "but the square thing is to have a post for every sheep to tie to!"

How many sheep must there have been in this famous flock?

CATS AND KITTENS PUZZLE

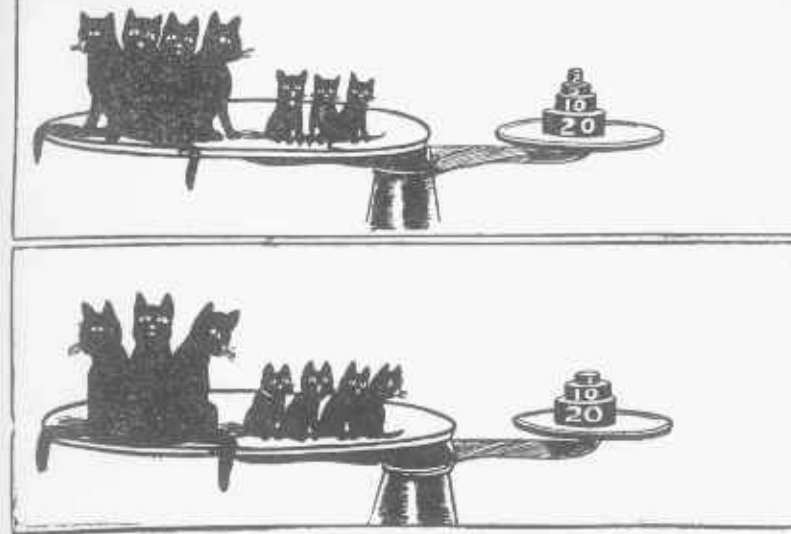

Elementary Lessons in Algebra.

Seeing that four cats and three kittens weigh thirty-seven pounds, while three cats and four kittens weigh but thirty-three pounds, we are asked to tell the respective weight of cats and kittens.

By inspection we see that the upper scale contains one more cat and one less kitten than the lower scale, and the difference is four pounds. One of the kittens in the lower scale suddenly grows into a cat and gains four pounds, so the difference between a cat and a kitten being four pounds, let us change all of the cats on the upper scales into kittens. It would then have seven kittens and sixteen pounds balancing with thirty-seven pounds. Now cancel off the sixteen pounds from both arms of the scales and we have seven kittens balancing with twenty-one pounds, which proves that a kitten weighs three pounds and a cat seven pounds.

A Rebus

So vast my amount fills the mind with dismay!
Behead me and thus take a thousand away;
Reverse what remains, and I'll daily dispense
To thousands the gift of a kind Providence.

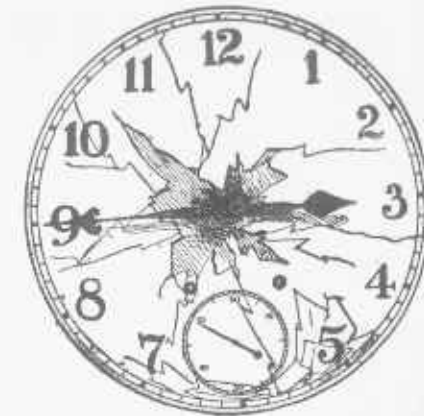

The above picture of a clock dial illustrated the important point of evidence in a detective story where a stray bullet from the assassin's pistol struck the face of the clock. It struck the exact center, driving the post through the works and stopping the clock. The two hands became united, as it were, in one line, pointing in opposite directions, although not in the position shown, for it is evident that the hand could not point at three and nine at the same time.

Can you tell what time of day it must have been, thereby proving an alibi for the hero who wishes to show that he was eating a plate of pig's knuckles in Hoboken at the time the pistol was fired in Sir Reginald's flat in Harlem?

A Rebus.

To a liquid reversed add what measures each day,
And you'll have what delights both the grave and the gay.
Cipher Answer.—16, 1, 19, 20, 9, 13, 5.

A Charade.

In fruitful field my first they grew,
My busy next there labored, too;
A hardy race my whole you'll find,
To husbandry and peace inclined.

Cipher Answer.—16, 5, 1, 19, 1, 14, 20, 19.

A Rebus

Behead a nail of stubborn steel,
A useful lesson to reveal,
In sacred records found;
Behead again, then at your will,
With art and perseverance till
Your grain producing ground.
Cipher Answer.—19, 16, 1, 18, 1, 2, 12, 5. (See Webster's.)



Here is a picture of Rip Van Winkle and his dog Schneider. The puzzle is to find the dog, but it is chiefly interesting to me as showing a specimen of my early engraving—more than half a century ago!

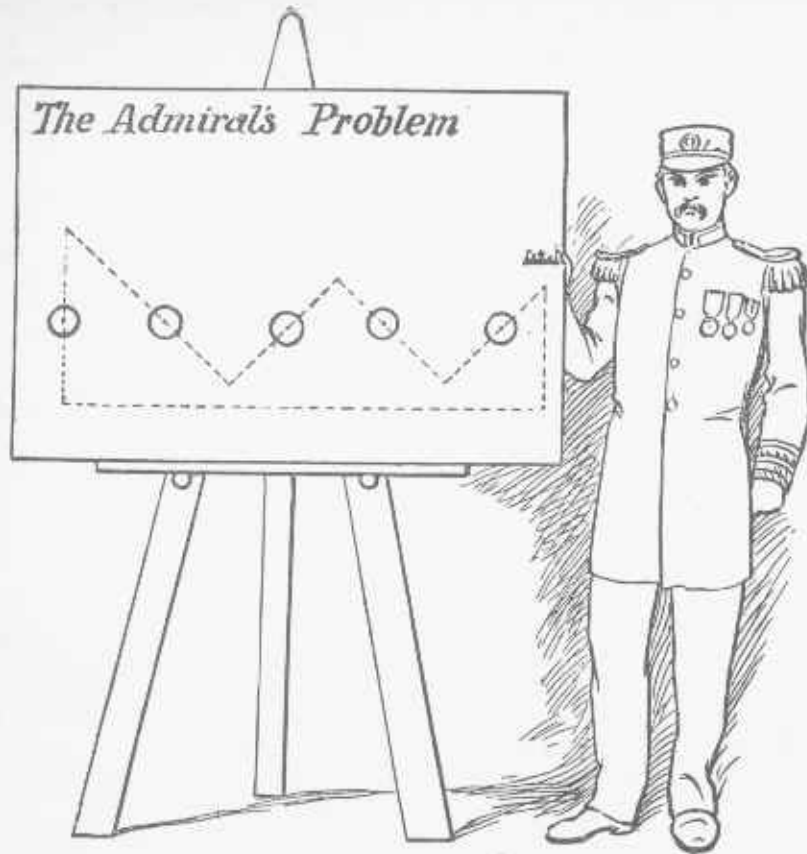

Admiral Togo is showing how a battleship might pass through the exact center of the five rings and back to the starting point in just seven straight moves. But the admiral tells his class in naval strategy that the feat can be done in less than seven moves. The puzzle, therefore, is to show in how few straight marks the trick can be done.

A Rebus

My first a useful barrier is
My next from harm to keep;
My whole upon some ruined tower
Does through the night watch sleep.

Cipher Answer.—23, 1, 12, 12, 6, 12, 15, 23, 5, 18.

An Illustrated Proverb.



Here is some valuable advice in pictorial form; the longer it takes you to guess it the better it will be impressed upon your memory.

A Rebus

My first mounts high when low you sleep;
My second's found within the deep;
And should you wish my whole to see,
You'll find it perched on yonder tree.

Cipher Answer.—19, 20, 1, 18, 12, 9, 14, 7.

Fun at Sing Sing.



Two pals who did "pick it" duty (oakum) at Sing Sing evolved the following problem: "If you gave forty seven cents for one hundred apples, and sold them for seventy cents, what per cent profit would you make on your investment?"

Picture Puzzle



There is no such thing as a bad puzzle, for everything that incites interest and amuses is useful, as it trains the youthful mind to concentrate; but of all the styles of puzzles, pictures which conceal objects possess the least known merit. I do not know as they teach anything. Nevertheless, I recall some pleasant moments spent over this old puzzle long, long ago. How we little ones used to delight to show it to visitors and ask, "Can you tell who Fannie is offering the hay to?"

A Rebus



Here is a pictorial puzzle which you will be very smart to guess in ten minutes.



Here is a financial problem pertaining to partnership relations, profit and loss or partial payments which I would not have to propose if that clumsy Dutchman had not placed his head so as to obstruct a view of the price of frankfurters.

It appears that three little boys from Harlem lost their way to school, and in their frantic efforts to locate the school, if it was to be discovered within the extended boundary of the metropolis, found themselves at the lunch hour wandering aimlessly along the Bowery at Coney Island.

When they all met under the long pier to discuss the various products of the place it was found that Harry had secured four frankfurters and Tommy seven. To pay for his part of the banquet Jim chipped in eleven cents, which Harry and Tom proceeded to divide between the two, so as to equalize finances. It has a puzzling look to the mathematician, but to these young boys, fresh from school, it was no more trouble to divide eleven between two than it was to put eleven frankfurters into three. In fact, it did not take them an instant longer than it did to decide not to harrow the feelings of their parents by mentioning their misfortunes. What they told their teacher would be too complex a question for our puzzlists. The present problem is to show how eleven cents were divided equitably between Harry and Tommy, which you can readily do when you have figured out the price of frankfurters.

The Herd of Camels.

An Arab sheik, finding himself about to die, called his sons about him and said:

"Divide my camels among you in the proportion of one half of the herd to the eldest son, the second son one-third, and to the youngest son one-ninth.

Thereupon the oldest son cried: "O, my father, one-half, one-third, and one-ninth do not constitute a whole. To whom, therefore, shall the remainder of the herd be given?"

"To any poor man who may be standing by when the division is

made," replied the sheik, who thereupon died.

When the herd was collected a new difficulty arose. The number of the camels could not be divided either by two or three or nine. While the brothers were disputing, a poor but crafty Bedouin, standing by with his camel, exclaimed, "Behold, I will sell you my beast for ten pieces of silver, so that you may then divide the herd."

Seeing that the addition of one camel would solve the difficulty, the brothers jumped at the offer, and proceeded to divide the herd, but when each had received his allotted portion there yet remained one camel.

"I am the poor man standing by," said the crafty Bedouin, and, gaily mounting the camel, he rode away, with the ten pieces of silver in his turban.

Now, how many camels were in the sheik's herd?

To the best of my knowledge and belief this beautiful problem has never been presented correctly before. In garbled form it is given in the puzzle books, or even by professors to illustrate a paradoxical situation which could be corrected by the introduction of one more camel. They omit the all-important sentence, "Divide the camels in the proportion of one-half and one-third and one-ninth." That word "proportion" is the saving clause which makes the problem sound.



Biddy was very sensitive on the matter of her age. So for the last two score years she has invariably answered queries pertaining to her earthly sojourn by the following little verse, which was doubtless quite correct when first perpetrated:

"Five times seven and seven times three

Add to my age and it will be
As far above six nines and four
As twice my years exceeds a score."

Can you tell Biddy's age?

The Greek Cross.

Eminent archaeologists and antiquarians like Le Plongeon, Schliemann, Prof. Wilson and others show that prehistoric man must have hit upon the crude sign of two crossed marks to indicate a human emblem, just as we in many instances employ peculiar brands or marks for similar purposes.

My present object, however, is to give a discourse upon those ancient emblems which have evolved the geometrical proportions of the Greek or mundane cross, which for upward of six thousand years has stood for the symbol of human intelligence, and is now recognized as representing science and mathematical exactitude. The symmetrical cross formed from five squares for thousands of years has been known as the Hindoo problem. By cutting it in five pieces, upon the principle of Euclid's forty-seven proposition, it will form a square. Almost all puzzle books give the scientific clipping of the four corners as shown by Fig. A to form the square B.

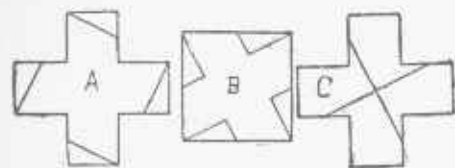

When a puzzle, however, can be done "a shorter way," "in fewer pieces," or in less moves," it is said to be "cooked," or, in puzzle language, "busted." Well, when I told the head of Harvard College that the symbol which was incorporated in the Harvard seal could be converted into a square by making four pieces instead of five, I was informed that the feat was impossible.

I used it as an advertising puzzle, offering a hundred dollars for the shortest method of converting the Greek cross into a square. Several hundred thousand answers were received employing five pieces, but not one answer that showed how to do it in four. Fig. C shows how the four pieces should be made.

I afterward discovered that there was an infinite number of answers, as the parallel cut may be made anywhere on the lines shown, and the perpendicular cut at any right-angled point of intersection.

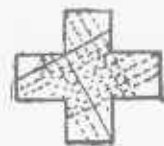

The four segments will always fit to form a perfect square, so the puzzle makers can exercise their ingenuity by introducing conditions or stipulations which will bar out all other answers but the one intended. In the illustrations given it is asked to divide a cross in four equal parts which will form a square. In a second puzzle it was said "to divide a cross, with two clips of the scissors, in four pieces, which will form a square."

There are numerous other problems connected with the symmetrical proportions of the Greek cross which make a most valuable lesson in the theory of all cutting puzzles.

A beautiful requirement is to divide a square in five pieces which will form two crosses. Fig. 1 shows how to produce five pieces which will form two crosses. The center piece makes a new cross, and the four outside pieces will form another. But, after the puzzle had become famous, I found a second way in one piece less, as shown in Fig. 2.

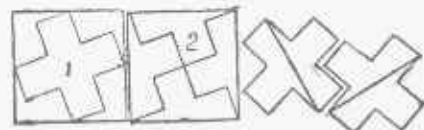

Another way to vary the stipulations so as to form a beautiful puzzle calls for the dividing of a square in

five pieces which will form two crosses of different sizes.

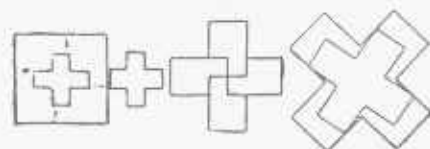

First cut out the little cross, then divide the remainder in four parts which will form the large cross, as shown. The fourth figure shows the puzzle of cutting a cross in five pieces which will form two crosses of equal size, and is one of the most beautiful problems of the series.

It is a most remarkable fact that a mysterious affinity or relationship can be shown to exist between all the ancient signs and symbols, in that each one can be converted into another by some subtle change which constitutes a clever puzzle. The Swastica can be changed into a square, the square into a cross, the cross into a triangle, an oblong or several crosses, and from these we can form a star, a crescent, oval, a monad, and from that a circle, which looks very much as if the squaring of the circle was one of the mysteries pertaining to the mystic signs and symbols.

A Puzzle.

My tongue is long, my breath is strong,

And yet I breed no strife.

My voice you hear both far and near,
And yet I have no life.

Cipher Answer.—2, 5, 12, 12.



In describing his experiences at a bargain sale, Smith says that half of his money was gone in just thirty minutes, so that he had pennies

where he had dollars before, and but half as many dollars as before he had pennies. Now, how much did he spend?

THE SCHOLAR'S PUZZLE



FENNIE was the brightest little girl in school; she carried off the highest honors in every branch of study, and, as a matter of fact, amused the entire school, teachers as well as scholars, with her clever tricks and puzzles. She met Joe the other day and showed him a new trick, which is just as pretty as it is clever. She drew six little rings on the fence and said: "Now you can only see two rows of three in a line as I have placed them, but I want you to mark out one ring and place it somewhere else, so as to show four rows of three in a line." What an easy puzzle! Just change the position of one ring so as to have four rows, instead of but two.

All puzzle books give that famous address that the person gave who wrote to

WOOD
JOHN
MAINE

which it is said reached the intended destination of John Underwood, Andover, Maine; but they failed to mention that this printed letter here tells where the epistle was sent from:



If I am not very much mistaken the following illustration was intended to give an idea of the date.



The Kangaroo Puzzle

Being an old sailor with a penchant for spinning yarns that require considerable saline seasoning, I do not mind telling you in strict confidence that I pirated the idea of this puzzle from the taffrail of a Dutch jigger which I saw riding at anchor in the bay during my last trip to Australia. I jotted down in my notebook at the time the suggestion that there was a possibility of every word having a mechanical peculiarity of its own, susceptible of being illustrated in puzzle form. As a proper souvenir of the occasion I present the following sketch of the taffrail of that boat. The name was painted in the twelve

Pictorial Algebra.



Here is an elementary study in arithmetic wherein you write down the names of all the articles, and

upper rings, and I suggested to my companion that it would make a pretty puzzle to find in how few moves the name could be moved down to the lower row. Astonishing as it may appear, it is safe to say that all of our puzzlists will know the name of that Dutch jigger when they have solved the puzzle.

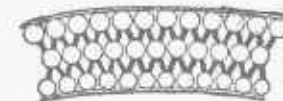

Select a word of twelve letters, and place the letters in their proper order in the upper row of the rings, one letter in each ring. Then move them down one step at a time, or jump one letter over another when possible, so as to spell the same word correctly in the lower row of rings, in the fewest possible moves. I think it was the jumping feature that suggested the name, or I might have described it as a Shakespearian puzzle, for though you may ask, "What's in a name?" you will find, as Hamlet says, "The play's the thing" wherein "to suit the action to the word and the word to the action," if you wish to perform the feat expeditiously.

A Rebus

My first earns his bread by the sweat of his brow,

Till my second compels him to cease;

When, if wise, what he gained by my whole may allow

Him to spend his last days more at ease.

Cipher Answer.—16, 15, 18, 20, 5, 18, 1, 7, 5.

A Charade

A well known tree transposed aright,
Will turn the darkness into light.

Cipher Answer.—16, 1, 12, 13.

THE ROYAL ROAD TO MATHEMATICS.

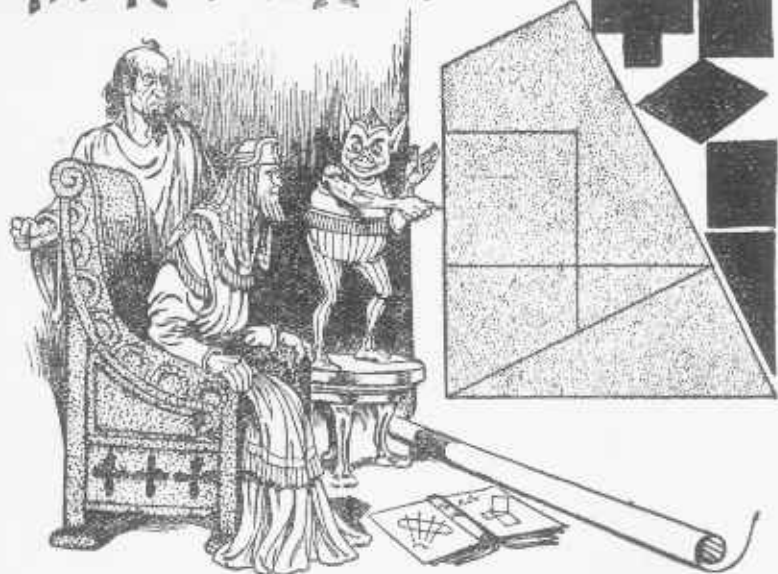

GAIN I am forced to tell your Imperial Highness that the royal road to geometry has not yet been discovered," exclaimed Euclid to King Ptolemy, who had been dozing during a lecture on the elements of geometry. "To illustrate the futility of knocking learning into a pupil's skull with a wormwood club," said Beppo, the court jester, "I make bold to volunteer a few soothing remarks.

"My learned friend has discoursed upon the six geometrical forms, the trapezium, the square, greek cross, parallelogram or diamond, rectangle and triangle. The trapezium, he has told us is a geometrical form with four sides, no two of which are parallel. The shape was originated many years ago as the mainsail for a catamaran, the five other geometrical shapes will readily be recognized as the flags or ensigns of ancient yachts. The most interesting part of the whole business is that I can mark off the trapezium into five parts, which form six wonderful puzzles. Cut these five pieces out of paper and it will be no easy task to rearrange them to form the trapezium. Then utilize all five of the pieces so as to form a perfect square! They will also fit together to make a greek cross. If properly placed they will make a perfect par-

allelogram, or a rectangle, or a right angled triangle.

"Thus we have the six geometrical shapes illustrated by these five magical pieces, and it is safe to say that by the time you have guessed these six puzzles you will be pretty familiar with the geometrical form, and won't have gone to sleep over Euclid's eleven volumes either! All of the five pieces must be utilized in pro-

ducing each of the patterns shown, just as in the case of the trapezium, and will go far towards teaching the mystic affinity or relationship between the different geometrical forms as treated by ancient occult writers."

A Remarkable Cut Price Puzzle.



It looks as if Isaacstein, the popular one price cash clothier, was determined to dispose of his stock at any old price, but you will discover that there is method in his madness if you realize that it requires one more mark-down to reach cost. See if you can figure it out.

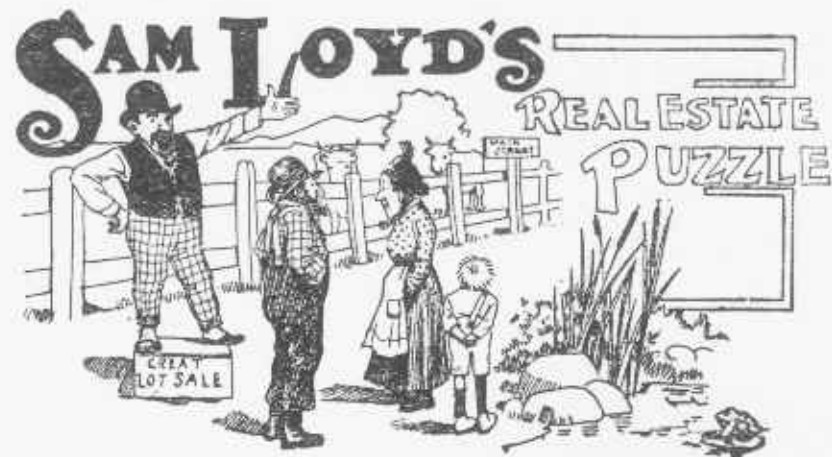

While the suburban boom is on we will take occasion to tell how a real estate speculator stopped off at a wrong station, and, having a couple of hours to wait for the next train, made a quick turn. He bought a piece of land for \$243, divided it

into lots, and sold them back to the original owners at \$18 per lot, and cleaned up the whole transaction before his train arrived. He made a profit on the deal just equal to his first cost price of six lots, so you are asked to tell just how many lots were laid out in the town of Boomville.

Puzzleland Park

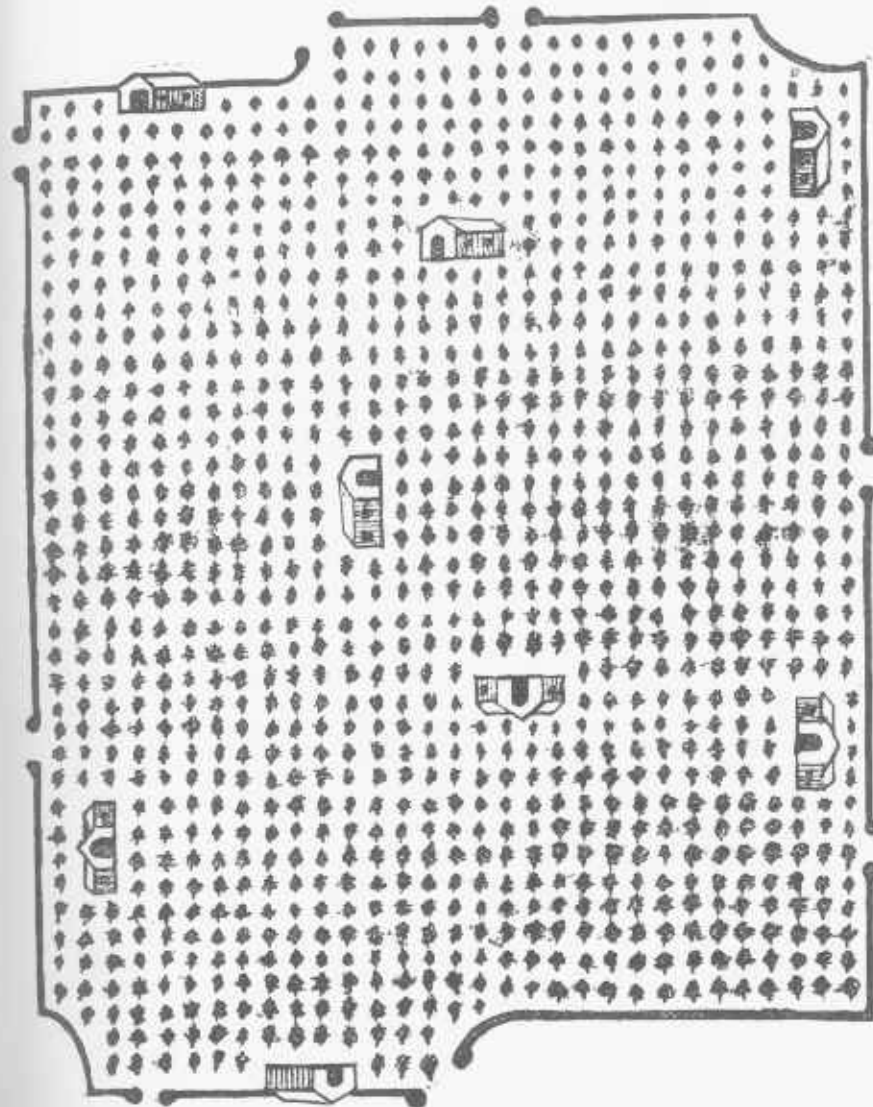

There are eight houses in Puzzleland Park, and the people of each house must only go out of the park by their private gate directly across, on a line with the door of their own house. Each family has a private path of their own leading to their gate between a row of trees; no paths cross any other paths; no inmates of one house ever meet any of their neighbors, so they never quarrel about which should turn out for the other in Puzzleland. Some of the paths are crooked and very funny, but as each one has a map with his particular route marked out by the landlord, who is a great puzzlist, they never get lost. Here is one of the maps, on which you are asked to

trace out the paths which each family must take to get to their private gate, across the park, but directly opposite to their door; but remember, none of the paths must cross!

The Hunter and The Squirrel.

Here is the old problem of the hunter who saw a squirrel on a tree and tries to get a good shot at it, but the squirrel cleverly manages to keep always on the opposite side. The hunter, as shown by the tracks in the snow, has gone around the tree so as to make a complete circle, but the squirrel has also gone around the tree, keeping on the opposite side, and we wish to know has the hunter walked around the squirrel? I give

the problem because puzzlists from all parts of the world have asked me to give my answer to the problem.

A thousand and one subtle argu-



ments have been offered to prove that the man does not go around the squirrel, principally based upon Webster's definition that around is, on all sides of; encircling, encompassing.

I claim that the man has most positively gone around the squirrel, just as the rim of a wheel goes around the hub which turns on the axle; just as the earth goes around the sun, which has a lesser orbit proportional to their difference in weight.

I remember going all around a field once, but a cross dog faced me all the time so I could not reach the apple tree; but I went all around that field and all that was in it. I wished at the time that I was big enough to take that dog by the tail and swing him around, but perhaps some philosopher would tell me that the dog was not being swung around, because he always had the same end toward me.

One of the same professors who maintain it is impossible to go around the earth unless the earth stops turning, places implicit faith in the old snake story. He says a snake can always swallow a snake of its same size; he once placed two four foot snakes together in a cage, and each seized the others tail and began to swallow it at the same time, so they both disappeared simultaneously. He asked Sammy to illustrate it upon the blackboard, and Sammy, who was quite a little artist, drew the following picture:



A Rebus

A bird select, on moorlands bred
And carefully remove its head;
Then your admirer, ladies see!
Cut his, and past and gone he'll be.

Cipher Answer.—16, 12, 15, 22, 5, 18.

MOTHER'S JAM PUZZLE



Mrs. Hubbard has invented a clever system for keeping tabs on her blackberry jam. She filled twenty-five jars and arranged the three sizes so as to have twenty quarts on each shelf. Can you guess her secret so as to tell how much one of the big jars contains?

Alfred Mercier says: "What we learn with pleasure we never forget," which is a more elegant way of expressing Josh Billings' trite saying: "There are better ways of knocking learning into a boy's head than with a wormwood club."

Tommy would like to learn how to extract unknown quantities from those jars of jam by reduction, elimination or even by the process of substitution of empty jars for full ones. The whole juvenile class would speedily reduce everything to the minimum quantities and clear off fractions if they were not awed by the mother's radical terms.

Like good Mother Hubbard we will solve the problem by inspection, and prove the quantities in the different jars. Knowing that each shelf contains just 20 quarts, let us begin

by cancelling off six little jars from the two lower shelves. The result proves that two big jars equal four medium ones, or one large one equals two medium size. Replace the jars and cancel the two large ones from

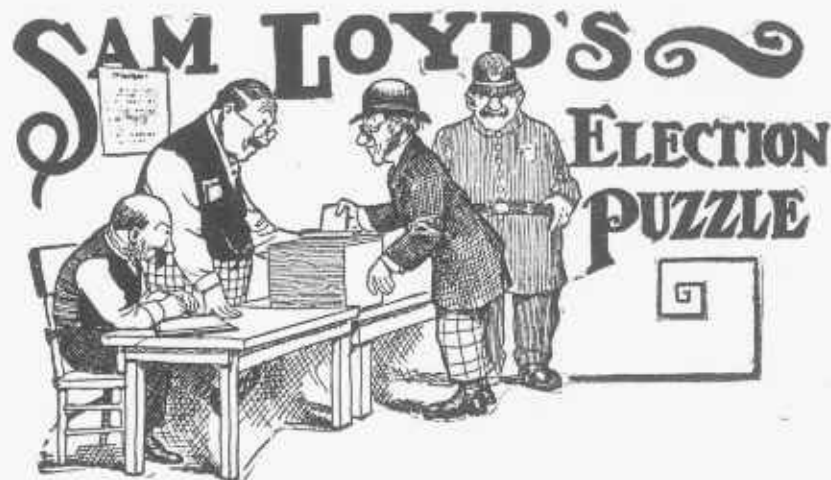

Here is a simple but somewhat pretty problem which developed at a recent election where 5,219 votes were cast for four candidates. The victor exceeded his opponents by 22,

the middle shelf and equalize the top shelf by removing the large one and two of the medium size. This shows that the one medium sized jar must hold as much as three little ones. Now multiply all the large jars by two and they are changed to mediums, and multiply the number then representing all the mediums by three to reduce them to the smallest size, and when we add them all together we find that the entire amount could be contained in 54 of the small size, 18 of the medium, or 9 of the largest. As a large jar would contain one-ninth of 60 quarts, we see that it would hold just six and two-third quarts.

A Rebus

My first on my second often there lies,
My first and my last should be of a size;
My whole, like my second, is always the same,
So now, if you're smart, just tell me my name.

Cipher Answer.—6, 15, 15, 20, 19, 20, 15, 15, 12.

A Charade

My first is found in many mines;
And there my costly second shines.
As for my whole—what shall I say?
It seems intended to betray.
Then, oh! beware, unthinking youth,
Adhere to honesty and truth.

Cipher Answer.—19, 20, 18, 1, 20, 5, 7, 5, 13.

30 and 73 votes, and yet not one of them knew how to figure out the exact number of votes received by each.

Can you give a simple rule for giving the desired results?

SAM LOYD'S VAUDEVILLE PUZZLE

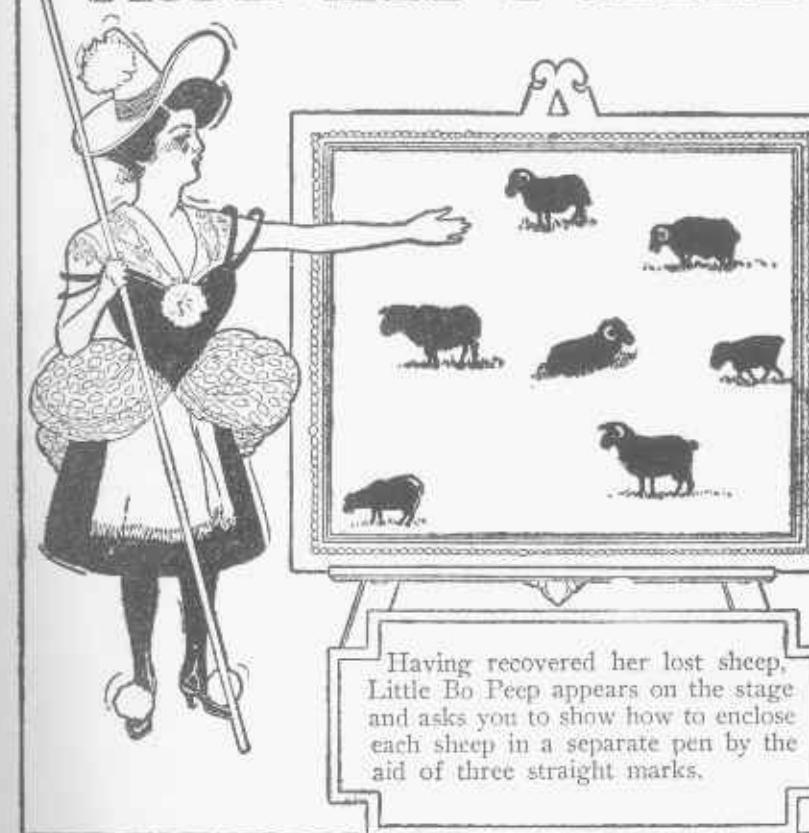

The Story of the Fish



The above sketch represents the greatest fish catch of the season, as told by the champion angler, who says: "The scales weigh nine pounds, and when putting the fish on the scales we find that they weigh three pounds. Now, take the fish off the scales and the scales off the fish and we find they weigh one-fifth of the weight of the fish without their scales. In view of the fact that the

weight of the fish without their scales is equal to one-fourth of the combined weight of the scales, what would be the weight of the fisherman if he is holding up just one-tenth of his own weight?" That is it! Never mind anything about the fish; what is the weight of the boy?

I don't know what the rest of the story has to do with puzzles, but, somehow or other, whenever I hear a story which makes a fellow stop and clear the cobwebs off his brain so as to think clearly, I say to myself that it is a good one to tell the class; wonder if it will bother them to see the point?

When Sammy brought his string of fish home his father said sternly:

"Sammy, I am going to punish you for disobedience. When I gave my consent to your spending a day at your grandfather's, I told you not to leave the place without his per-

mission. And yet you ran away and went fishing all the afternoon."

"But grandpa said I might," answered the lad.

"Come, come, sir! Your grandfather says you did not even mention the subject to him."

"Pa—"

The lad stood on one foot.

"Well?"

"There is an old saying that 'the child is the father of the man,' isn't there?"

"Yes."

"Well, then, that makes me your father, doesn't it? And if I am your father, of course I am also your son's grandfather. Your son asked me if he might go fishing, and told him he might if he would be a good boy. He said he would be, and he kept his promise, pa."

Here the lad stood on the other foot.

"Clarence, my son," said the fond father, with great feeling, "take good care of your health, for if you live you'll be a lawyer yet."

A Compound Rebus.



The students have tied one of their comrades in the tent; how do you know that he is not a young man?

How do you know that he is a scholar?

How do you know that he is smarter than his fellow students?

A Rebus

A pendant charm, bereft of tail and head,

A quadruped will give you in its stead.

Cipher Answer.—1, 13, 21, 12, 5, 20.

Mrs. Pythagoras' Puzzle

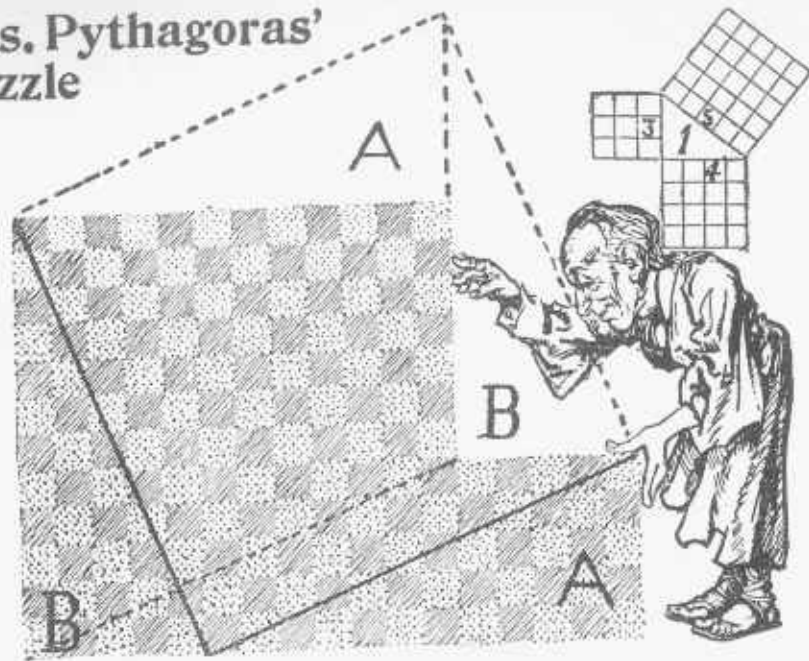

"I am feared these goods will fray if they are cut on the bias, so I want to get along without that hippopotamus line. Here is a plan which will also do it in three pieces: Cut out that long piece marked A, and stand it on end at one side; then move the piece C down one step, and it forms a 13x13 square, all right, all right."

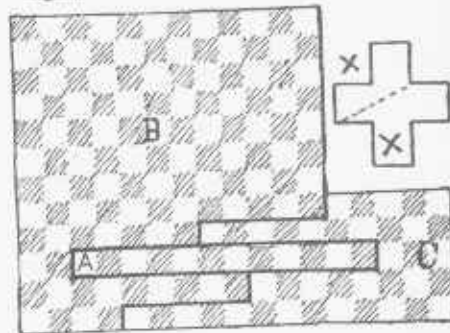

"But, I don't like it altogether, Thag; you see the pattern don't run quite right on the squares in that long piece. Can't you find a perfect answer without giving any of the squares that half turn? I know it can be done."

There we have Mrs. Pythagoras' new puzzle.

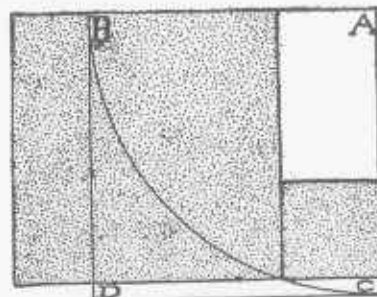

On the principle that every good rule should work both ways, we will now reverse the idea so as to produce two squares from one large square. Place the point of the compasses at A and describe the arc B C and any point on the arc will indicate the junction of the two smaller squares, which are equal to the area of the largest A B D C, and brings us back to a two-square form of any desired dimension.



It is easy to prove the truth of Euclid's famous proposition by erecting four triangles around the hypotenuse square C. The area of the large square being $(A+B)^2$ equals $A^2+2AB+B^2$; subtracting the contents of the 4 triangles $2AB$ proves A^2+B^2 of the side and base equals C^2 of the hypotenuse.

A SHORT TALK ABOUT TELEGRAPHY.

I went to Europe with Prof. Morse in 1865, and I remember one day while speaking about our ages he laughingly remarked that he invented the telegraph during the year I was born. He told many interesting things connected with the progress and development of what is known as the Morse code. As a souvenir of the occasion he dotted down in my note-book the following alphabet, accompanied by valuable instructions which I cheerfully pass on to the rising generation:

It never was contemplated that the messages should be taken by sound, but after years of practice in reading the tapes the modern expert developed and the old-time op-

erator was driven out of business. Don't imagine, however, that you could begin to take messages by sound; anyone can send a message, but it requires great practice and perfect familiarity with the alphabet to be able to note the differences between intervals in the ticks. Practice reading and writing telegraphy for months without thinking of the sound until you are actually an expert. Prof. Morse explained that the difference between a dot and a dash was just about as much as between the word "dot" and "dash," so to learn the alphabet, take a pencil and hit a quick, sharp blow, and say "dot" and for the dashes give a stronger push and always say "dash" and give a somewhat longer wait between the letters and a somewhat longer dwell between words. For ex-

ample in learning the alphabet say: A dot dash, B dash dot dot dot, C dot dot dot. Now do you notice that there is a little more space between those last dots? You would only detect that after you were a thorough expert. D dash dot, dot, E dot, F dot dash dot, G dash dash dot and H is dot dot dot dot.

I never became a real expert operator as I had no occasion to practice the same professionally, but at Professor Morse's suggestion I wrote several pages of the code until I became familiar with it. I learned this as well as many other things which I propose to talk about, merely as an accomplishment for my own amusement. "A little learning may be a dangerous thing," and "a jack of all trades may be a master of none," but I believe more in the old saying: "all work and no play makes Jack a dull boy." A boy who knows a little about everything is better than the boy who knows nothing about anything. Let the young store their minds with congenial knowledge and they will never forget it.

Just to familiarize you with the Morse alphabet, I will take occasion to tell a little incident which befel the professor and myself on our return to New York, by the time you have deciphered it you will have a very good idea of the technical features of the code.

A	B	C	D	E	F	G	H
· -	- · · ·	· · · -	- · ·	- ·	- · -	- · -	· · ·
I	J	K	L	M	N	O	
· ·	- · - ·	- - -	- -	- -	- · -	· · -	· · ·
P	Q	R	S	T	U	V	
· · · ·	· · · -	· · ·	· · ·	- - -	· · -	· · -	· · ·
W	X	Y	Z	&			
- · - ·	- · - ·	- · - ·	- · - ·	- · - ·			
,	?	1	2	3	4		
· ·	· ·	· ·	· ·	· ·	· ·	· ·	· ·
5	6	7	8	9	0		
- · - ·	- · - ·	- · - ·	- · - ·	- · - ·	- · - ·	- · - ·	- · - ·

The letters are readily learned by studying the scientific combinations of the dots and dashes. A single dot is E, two dots I, but if they are a little further apart, O. Three dots represents S, but with a little more space between the first and second, becomes

R; this reversed would be C. All of the letters change by reversal, so they should be learned in pairs. A changes to N, B to V, D to U, G to W, Q to X, and Z to &. A single dash represents T, but a longer dash is L. Anyone could learn the combinations in

fifteen minutes. I have not looked at them for nearly half a century, and here I am with my shaky old hand, writing out the above dispatch. Just for fun I send it to Tom Edison to see if I have made any mistakes.

WHEN Mrs. Pythagoras took counsel with her spouse regarding the best way of squaring a two-square formed remnant of Athenian matting, the great philosopher explained: "Knowing that a square erected on the hypotenuse line of a right-angled triangle is equal to the square of the base and the square of the side combined, we see that the square you require must be equal to both squares, and therefore must be equal to the square of the hypotenuse."

understood any number of squares or circles may be added together at a glance,

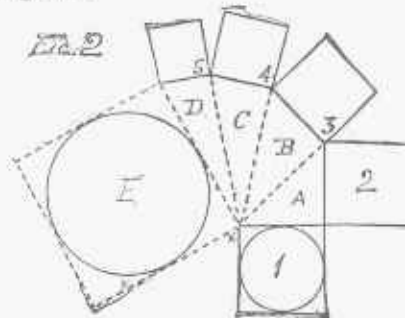

In the above illustration 1 and 2 would form a square equal to the hypotenuse line of A. Squares 3, 4 and 5 are each added to the hypotenuse lines, showing that the square E is as large as the five small ones. All manner of forms, like rhomboids, pyramids, crosses, etc., can be transformed into squares by this method, which is invaluable in the world of puzzlement. In the following small figure of a cross we see that the lower square X would fill the upper space Y, thereby forming a two-square form, which we know how to transform into a square which we can see must be of the dimensions of that dotted hypotenuse line.

But to get back to Mrs. Pythagoras' matting puzzle, which the great philosopher offered to solve upon the principle of Euclid's 47 proposition known as pons asinorum.

"Now, Thag," says she, for she always called him that in the house,

The truth of this great theorem is shown in the small illustration. No. 1 shows a right-angled triangle; being three inches high, the square of that side contains nine square inches; the base, being four inches long, contains sixteen square inches, and the five inch hypotenuse square contains as many square inches as both of the other squares added together.

If we wish to make one square out of two we merely place them together and draw a straight line from the top of the smallest and draw the line through the larger to the lower corner, B to B, and it will form the hypotenuse line of a triangle, giving the length of the square which will be equal to both of the other squares. A beautiful demonstration is shown in three pieces by clipping off the triangular pieces and fitting them above as shown. It will always make a perfect square from any two-square shaped piece of paper.

When this principle is thoroughly

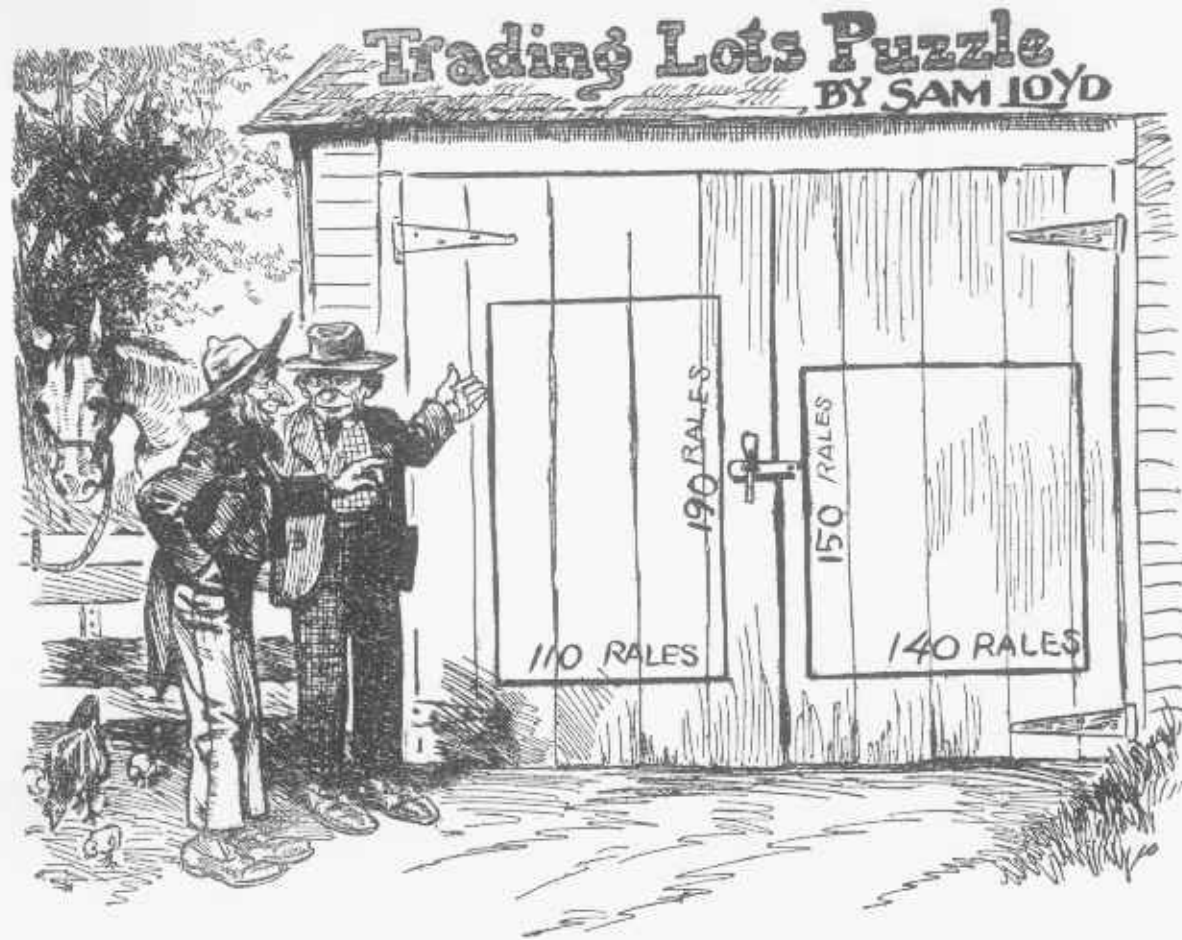

PROPOSITION—Here are shown the dimensions of two fields, the one enclosed by 580 rails, the other by 600. An acre contains 43,560 square feet and will raise 840 squashes. What will be the relative squash crops of the two fields?

OF COURSE ALL mathematicians, as well as such as have a natural bent towards the principles of geometry, appreciate the perfection of the form of the circle as compared with all other shapes. The nearer an oblong, square or polygon approaches the form of a circle the greater will be the surface in proportion to the length of line required to enclose it. This proposition is well illustrated in the following problem which is given to show that the length of fence required to enclose a field gives no indication of the acreage.

It appears that two Hayseeds, who knew nothing about an acre of land containing 43,560 square feet, had been figuring out on the barn door a smart dicker which they concluded with Farmer Sykes' boy, who was fresh from college.

They traded one large field for another, and believed that they got the best of the bargain because

it took more rails to enclose the new field. Their old lot had 140 rails on one side by 150 on the other, which would make 580 rails on the four sides. The field for which they traded has 110 rails by 190, which would make 600 rails on the four sides.

The dimensions of the two fields are correctly shown on the barn doors and illustrate a valuable lesson in geometry pertaining to form and dimensions. To present on problem in tangible form, let the proposition be: Supposing that 840 squashes are raised to the acre. How many squashes will those smart Alocs lose on the year's crop by trading fields? or, in other words, how much does Farmer Sykes' boy's knowledge of elementary geometry profit him per year in this one little transaction, to say nothing about the thousands of opportunities which will occur during the year for him to turn his practical knowledge of mathematics to account?

Why, when you paint a man's portrait, may you be described as stepping into his shoes? Because you make his feet yours (features).

Why may a beggar wear a very short coat? Because it will be long enough before he gets another.

Which is the most valuable, a five-dollar note or five gold dollars? The note, because when you put it in your pocket you double it, and when you take it out again you see it increases.

Why is a pretty young lady like a wagon wheel? Because she is surrounded by felloes (fellows).

What is the difference between form and ceremony? You sit upon one and stand on the other.

What is the most awkward time for a train to start? 12:50, as it's ten to one if you catch it.

Why is a camel a very pugnacious animal? Because he always has his back up.

Why can the world be compared to music? Because it is so full of sharps and flats.

THE HOUSE OF BETSY ROSS



AS THE BETSY ROSS trick of cutting a five pointed star with one clip with a pair of scissors has never been intelligently presented, I will endeavor to show how it was explained to me in my early youth. I wish it to be known that I was born in close proximity to that little house on Arch street in Philadelphia where Betsy Ross showed George Washington and Robert Morris how to design the five pointed star of freedom.

There are several ways of performing the feat, but I consider the following to be the best and most easily described. Take a rectangular piece of paper, say five by three and a half inches, and first fold it double as shown in Fig. 1. Then fold on a line from the center A to the two corners, folding the corner marked B forward and the corner C backward, as shown in Fig. 2. Now fold the paper on a line from C to the center point A, so as to bring the edge D parallel with the line B as shown in Fig. 3. Then fold the end E backward, bending it on the line from B to the center point A so the paper will be folded as shown in Fig. 4. Now, cutting a straight clip from F to G, it will produce the five

pointed star as shown by Fig. 5. The usual method, which has to be done more or less by guesswork, is shown in the next three illustrations.

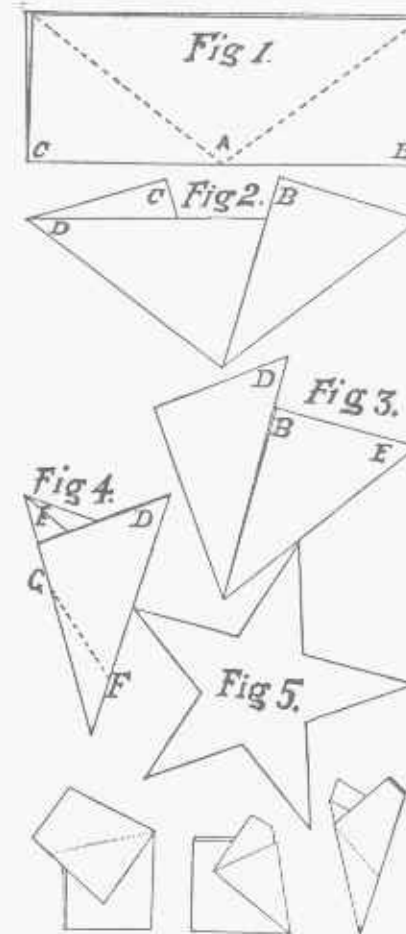

First fold a perfectly square piece of paper in half as shown, and bend it from the center point so that the double edge intersects the middle of the top. Then fold down the top on that dotted line so as to look like the second illustration. Then back the bottom piece on that bias line so it looks like the third illustration, and a cut on the dotted line will produce the shape similar to the other.

A Rebus.

Two words there are—the first will tell
What may be found in many a soil,
Where various treasures silent dwell;
And if you know their natures well,
The second may reward your toil.
Unite them, and you'll quickly guess
What I have tried in vain with you;
'Tis what I used, I must confess,
With little skill and less success,
To hide my meaning from your view.
Cipher Answer.—19, 20, 18, 1, 20,
1, 7, 5, 13.

A Rebus.

Two words which denote what old
Shylock will hold
On your house, or your land, ere he
lends you his gold,
Enjoined, name a being who wanders
from home,
And in many strange climates may
sojourn or roam,
But where'er he may be, in town,
country or strand,
He can never exist in his own native
land.
Cipher Answer.—1, 12, 9, 5, 14.

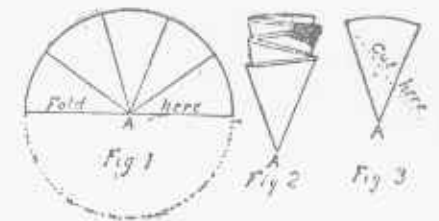

It just occurs to me to say that I remember as a boy that when I wished to make a perfectly symmetrical five-pointed star, I used to first cut out a round piece of paper and, folding it as shown, I would bend it in five parts and then give it one clip with the scissors, which insures a perfect star.



Here is a most interesting illustration of what might be termed an optical illusion. Look steadily for about ten seconds at the little star in the center of the above design, then, without winking, suddenly gaze at some small point on a sheet of white paper, the ceiling, or a blank wall. After a few attempts, by gazing intently at the one spot for ten or twenty seconds, the blurred form which first appears will assume the well-known features of a celebrated general.

It would appear to prove that color is purely a freak of the imagination, and that the colors we think we see are really created by the retina of the eye. Look intently at a bright colored spot, like the ace of diamonds or hearts, and then gaze at the blank wall or paper and you will see the red has changed to a bright green.

Artists employ this method to find what are the party color or complement to shade certain colors with, because the new color which appears on the space is the opposite to the color of the spot you have first looked at, as white is to black, green to red, etc. The mysterious feature of the experiment is that you now see a new color which exists only in your imagination.



THE PROBLEM of squaring the circle may be described as changing circular into square measure. The mind being trained to estimate in squares, refuses to deal with circles. A plane has a length and breadth, but no thickness. We say a lot is 25 x 100, or a shadow is 10 feet wide by 20 long. We talk about superficial surface without substance. Thickness pertains to the third power and introduces a new dimension which the mind can grasp. A tank 20 x 20 gives no idea of its capacity until we learn that it is 10 feet deep. Then 20 x 20 x 10 shows that it will hold 4,000 cubic feet of water.

If our ancestors had estimated in spheres with the diameter of a small marble as the unit of measurement, we might all be talking in circles, with the mathematicians trying to circle the square.

For thousands of years they have sought to discover the ratio of the diameter to the circumference as the key to the great problem. Ingenious methods have been employed which produce answers approximately correct, but there is always an infinitesimally small fraction left over which is technically known as π .

The ancients claimed the diameter to be one-third of the circumference, and had biblical authority for the same, as we read in the Book of Kings, VII, 23, that Solomon in making the vessels of the Temple "made a molten sea, ten cubits from one rim to the other, and a line of thirty cubits did compass it round about." This is but one of many references in the Bible to the ratio of the diameter of the circum. being one-third, this ratio gives a fairly good approximation, but for careful estimating we divide the circumference, or multiply the diameter by the decimal fraction 3.141592. From any given diameter we obtain an approximately correct answer to an infinitesimal degree by squaring the radius and multiplying it by π . It may be said that calculations have been carried out to seven hundred decimal points in the vain hope of hitting upon a cycle of repeating decimals which would close the circuit so as to give a definite value to π .

Here is the process worked out to seven hundred and seven points:

3.141592653589793238462643383279502884
1971693993751058209749445923078164062862
0899862803482534211706798214808651328230
6647093844609550582231725359408128481117
4502841027019385211055596446229489549303
819644288109756659334461284756482337867
8316527120190914564856692340034861045432
6648213393607260249141273724587006606315
588174881520920962829254091715364367892
5903600113305305488204665213841409519415
1160943305727036575950195309218611738193
2611793105118548074462379834749567351885
7527248912279381830119491298336733624419
364308622139501609244807723094362855309
6620275569307986950222474996206074970304
123668861995110080202383702131416941190
2988582544681639799904659700081700296312
377381342084130791451183980570985.

This stupendous calculation may be appreciated by explaining that you might imagine a sphere to be constructed with the earth as the central point and the orbit of the circle to extend to the star

Sirius, distant a hundred million miles—but you may make it a billion times farther if you wish—then imagine this immense sphere packed with minute microbes, so small that a billion could stand on the point of a pin. Now multiply that radius of the great circle by those seven hundred and seven decimals and the error as to the space filled with microbes will be less than the billionth part of a microbe!

The interest in the squaring of the circle has been kept alive by the offer of 100,000 francs by the Paris Academie of Sciences, and by the claim that the secret was known at the time of the building of the pyramids. The Paris Academie has withdrawn its offer and says it "will examine no more squaring problems, no more trisections of the angle, no more duplications of the cube, and no more perpetual motion schemes."

The offer was withdrawn because Prof. Gauss gave a rigid and positive demonstration of the impossibility of solving those problems mathematically. Prof. Gauss' proof is too profound and technical for the average student, but for the benefit of the thousand and one aspirants for fame who believe that they have new methods for solving the great problem we will put a new and interesting value to Mr. Shanks' seven hundred and seven point demonstration as a test wherewith to compare the new solutions. The greatest mathematicians of the world have indorsed his work as correct, and it has been approved by the Royal Society of London, Vol. XXI. All that is necessary to see how far the new methods compare with Mr. Shanks', and at what point they fail: It may be said that out of the hundreds of thousands of mathematicians, many of whom devoted their lives to the task—very, very few were correct as far as the fifth or sixth decimal, and here we have an absolutely correct standard up to seven hundred and seven points!

And now for a practical rule and explanation for the benefit of the engineer and mechanic, which when once learned will never be forgotten. To square a circle, multiply half the diameter (in inches) by half the circumference (in inches). The answer will be absolutely correct, and not merely approximately near, as many suppose. It is practical, because if you wish to know how many feet of sod will be required to cover a round grass plot, you take the tape and measure the circumference and the diameter, and multiply the half of one by half the other, and if your measurements are correct it will give the amount of sod required to less than the billionth part of an inch.

If the plumber wishes to know the contents of a circular boiler or cistern, let him measure the diameter and the circumference with the tape, then multiply the half of one by half of the other and the result by the depth, and he will have the capacity as close as a single drop of water. The correctness of the answer depends altogether on the accuracy of his measurements.

A tinsmith had to cover a circular roof 100 feet in diameter. Actual measurement made the circumference to be 314.16 feet. By the use of this rule he found it required 7,854 feet of tin, which was not a square inch out of the way.

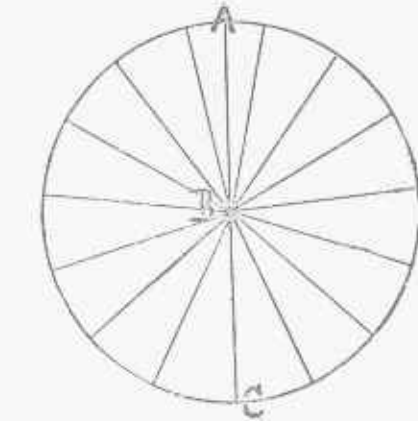

Now let us square that circle of the orange by the rule. Suppose the circumference proves to be 93.7 inches, and the diameter 3 inches; the half of the one by the half of the other gives 7 and 1-14 square inches as the correct answer. But why? Suppose the circle was cut in half from A to B, as shown on the circle. Now take each of the pieces of orange and straighten out the peel as shown in the following cut. It is clear that each

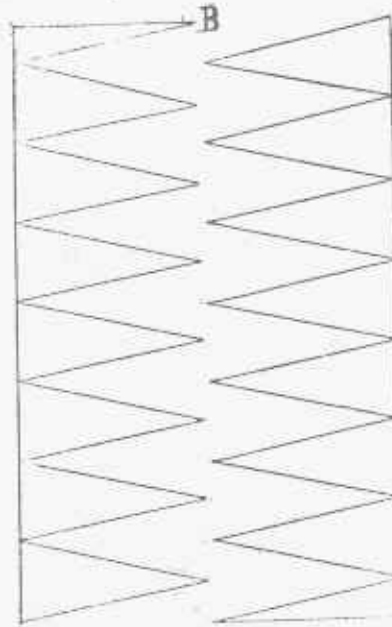

piece is as long as half of the circumference, because two pieces formed the entire circumference. The pulp is broken or separated into segments which are evidently half as wide as the diameter because they reached from every point of the circumference to the center at B. As these triangles taper from the half of the circumference to nil at their points, we will bring the two pieces together so as to fit them into a solid oblong one and a half inches wide by 45.7 inches long, containing a surface of 7 and 1-14 inches as stated.

As the reason why has to be taught to impress it upon the mind, we will give a little kindergarten illustration which explains everything. If you halve an orange you will notice how the pulp of the fruit is divided into triangular looking segments of a circle converging to the center B, as shown in the following illustration.

THE FIRE ESCAPE PUZZLE BY Sam Loyd.

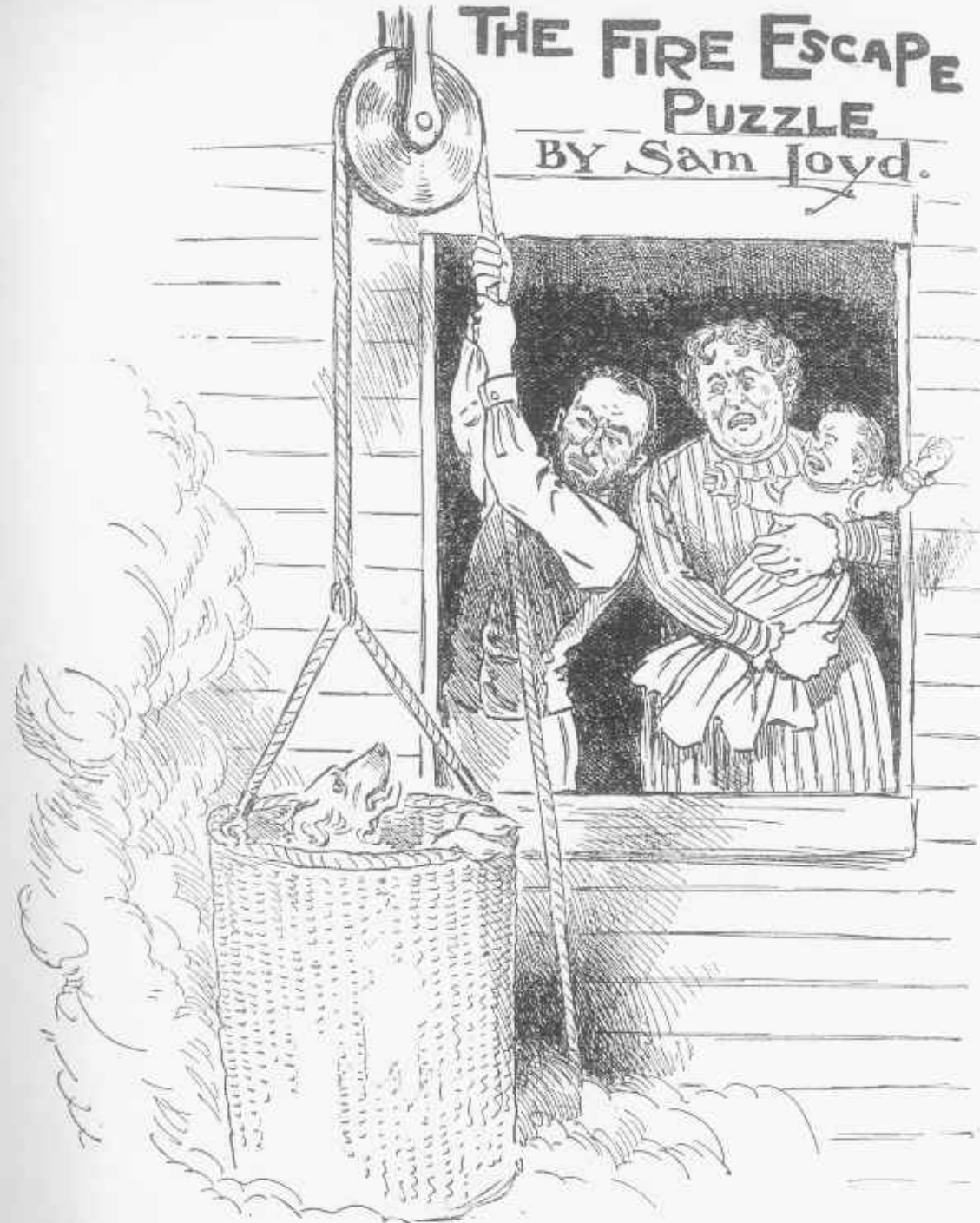

THIS PUZZLE IS BUILT upon common sense, and represents the Binks patent fire escape which the inventor says should be placed in every sleeping room in the world. It was tried at one of our hotels, but delinquent guests had such a way of decamping during the night with their worldly possessions that the scheme no longer finds favor with the landlords.

It is merely a rope with a large

bucket at both ends running over a free pulley, so that when one bucket goes down the other comes up. The ingenuity of the scheme consists in putting some object in one bucket to act as a counter balance to a heavier article to be lowered in the other.

Now then, supposing that thirty pounds is the limit of difference which would not cause your feelings to be jarred, the following problem presents itself in a way to be readily understood:

A fire occurred one night at a fashionable summer hotel, and all of the people escaped in safety except the night watchman and his family who could not be aroused until all ways of escape were cut off except by the Binks elevator. Now, the combined weight of Mr. Watchman, Mrs. Watchman, baby and dog amounted to just 390 pounds, so the problem is simply to show the quickest way of lowering the family, thirty pounds at a time.

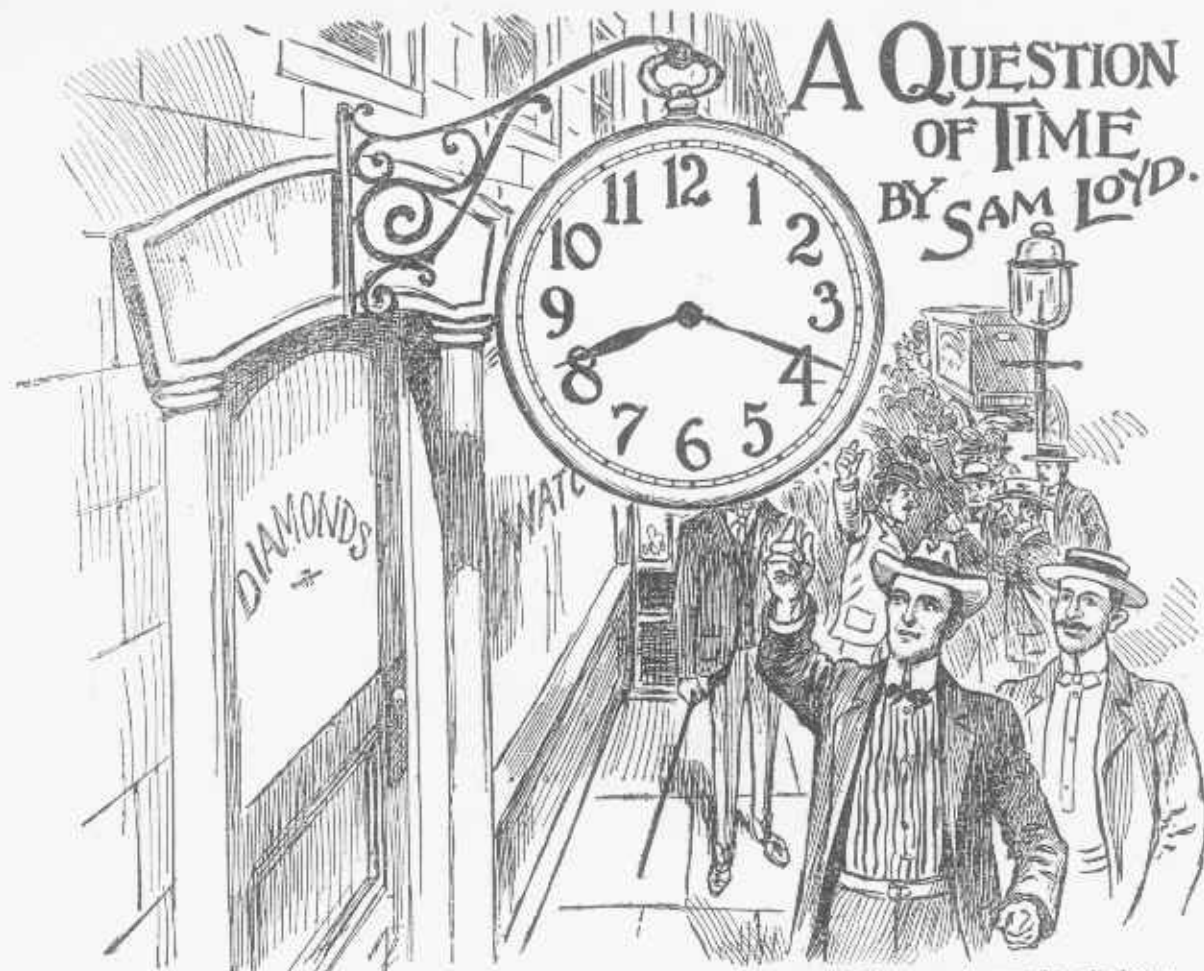

A QUESTION OF TIME BY SAM LOYD.

PROPOSITION—When the hour and minute hands are at equal distance from the six hour, what time will it be?



CURIOUS paragraph has been going the rounds of the press which attempts to explain why the signs of the big watches in front of jewelry stores are always alike. They are painted upon the dial, apparently in a hap-hazard sort of a way, and yet they invariably indicate a certain number of minutes past eight. It cannot be attributable to chance, for it would tax one's credulity to believe that such a coincidence could occur all over the civilized world.

There is no accepted rule or agreement established with the jewelers or sign painters, for careful inquiry proves that few of them are aware of the fact or ever noticed that any two are alike. It would be a marvelous case of unconscious imitation if it is looked upon as a mere custom, accidentally following a pattern set by the originator of the device of the sign of a big watch. In London, where they take pride in

such things, I saw several big watches, looking as if they had hung in front of the stores for countless centuries, all indicating the same mysterious time, accompanied by the announcement that the firms were established a couple of hundred years ago. I do not doubt for a moment that some such similar sign can be found at Nuremberg, where the watch originated during the Fifteenth Century.

The discussion seems to have brought out a recognition of the fact that from an artistic point of view, symmetry requires that the hands should be evenly balanced, as it were, on both sides of the face of the watch.

If they are raised too much there is a certain "exasperating, declamatory effect" which is not altogether pleasing.

The time would be incorrect if the hands pointed at 9 and 3, and at other points would be too low, so, as a matter of fact, and from an artistic point of view, the position is

well selected and is one of the points which, with the aid of a watch, can be shown to be possible. It is a fact however, that the mere puzzle of telling what time the watch indicates, has been held up to public gaze for all these centuries without being thought of or solved?

Take your watch and set it to the time indicated, with the hands at equal distances from the six hour, which shows it to be a possible position, and then tell what time of the day it is!

This is one of the many interesting puzzles which will be introduced to explain in a simple way several problems of the clock and divisions of time with which every one should be familiar.

How many boys know that a cord and stone will time a race more accurately than a \$1,000 stop watch?

It is safe to say that few know that a watch can be used instead of a compass, or that with the aid of a compass you can set your watch correctly!

CROSS AND CRESCENT.



Here is a pretty and scientific puzzle closely allied to Hypocrates' famous mathematic problem of the relation of a square to a lune. The problem in this case being to discover how to convert the crescent into the form of a Greek cross, as shown upon the goddess' head, by cutting the moon into the fewest possible number of pieces which can be fitted together so as to form a cross.



A-PUZZLING MIXTURE

BY SAM LOYD.

IT IS TOLD THAT AN honest and unsophisticated milkman, who had boasted much about his conscientious dealings and the fact of his never having disappointed a customer, found to his dismay one morning that his supply of milk was inadequate to the demands of his patrons. In fact, his stock was much too short to serve his route, and there was no possibility of getting any more milk.

Realizing the serious consequences which might result to his business, to say nothing about the disappointment and inconvenience to his customers, he was at his wits' end to know what to do in his dilemma.

After turning the matter carefully over in his mind he determined that as he was too conscientious and fair-minded to show partiality by serving some and passing others, he would have to divide what he had among them all, but would dilute his milk with a sufficient quantity of water to make it meet all demands.

Having found, after diligent search, a well of exceedingly pure water which he could conscientiously employ for the purpose, he pumped into one of the cans as many gallons of water as would enable him to serve all of his customers.

Having been in the habit, however, of selling two qualities of milk,

one for eight cents a quart and the other for ten, he proceeded to produce two mixtures, in the following ingenious manner, which is suggestive of a clever and interesting puzzle:

From Can No. 1, which contained only water, he poured sufficient to double the contents of Can No. 2, containing the milk. Then from No. 2 he poured back into No. 1 just as much of the mixture as he had left water in No. 1. Then, to secure the desired proportions, he proceeded to pour back from No. 1 again just a sufficient quantity to double the contents of No. 2, which leaves an equal number of gallons in each of the cans, as may be readily shown, although there are three gallons more of water than milk in can No. 2.

Now, this is not as complicated a transaction as it looks, for it requires but three changes to equalize the contents of the two cans, but assuming that pure milk cost him two cents a quart, I wish to know how much money he received altogether if he sold out the entire stock at ten cents and eight cents a quart?

It is a pretty problem from the ordinary affairs of life well worth knowing, as it gives an idea of the profits of the milk trust, and explains the Farmers' Union formula for producing standard milk.

A Legal Problem.

A correspondent who wishes to lay claim to an estate in chancery asks if there is a law in any of our states which would have prohibited his grandfather from marrying the sister of his widow. He says that the entire proof of his right of inheritance to an old farm now covered with sky-scrapers and palatial residences turns upon the solution of this question.

The problem has gone the rounds of the puzzle world as a clever catch which turns upon the point that a man must be dead to make his wife a widow, so he could not marry his widow's sister. Nevertheless, there is a good catch within the catch question which fairly reverses the popular answer. From a legal, as well as a practical, standpoint we would inform our correspondent that there was neither law nor objection to his grandfather having married the sister of his widow. Suppose A and B are sisters. The man in question marries A.; she dies, leaving him a widower. He then marries B., who survives him and becomes his widow. Thus he may be said to have married his widow's sister (A.), though she was his first instead of his second wife. The grandson is therefore legally entitled to the old farm with its crop of sky-scrapers.



THE Convent Problem

BY SAM LOYD



AS PERTINENT TO A reference to unsolved, or ancient puzzles the true conditions of which seem never to have been correctly understood, I wish to call attention to one which is popularly known as the Problem of the Nuns. It appears in almost all collections of puzzles, but is very childish and the answer too weak to satisfy the expectations of solvers.

I remember that the answer was very disappointing when I first saw it many years ago, and I recall the accompanying statement about its being of Spanish origin and founded on an incident which occurred many centuries ago. Recently I came into possession of some very old Spanish histories, in one of which I find a brief allusion to the convent of Mt. Maladetta, situated on the mountain of that name, mentioned as being the highest peak of the Pyrenees. Reference is made to the occupancy of that part of the country by the French invaders who were finally defeated and driven out through that famous pass which was the scene of many contentions for over a century.

The direct allusion to the puzzle, however, occurs in the passage which says: "Many of the nuns were carried away by the 'Frank' soldiers, which without doubt gave rise to the familiar problem of the nuns of the

convent of Mt. Maladetta."

As no explanation of the puzzle is so susceptible of double solutions, I take the liberty of presenting it in a form which preserves the spirit of the problem and at the same time eliminates the many other answers.

The convent as shown in the picture, was a square three-story structure, with six windows on each side of the upper stories. It is plain to be seen that there are eight rooms on each of the upper floors, which agrees with the requirements of the old story. As the legend goes, the upper floors were used for sleeping apartments, of which the top floor, having more beds in each of the rooms, accommodated twice as many occupants as the second floor.

The mother Superior, in accordance with an old rule of the founders, insisted that the occupants must be so divided or arranged that every room should be occupied; there should be twice as many on the top floor as on the second, and that there must always be neither more nor less—just eleven nuns in the six rooms on each of the four sides of the convent. Of course it is plain to be seen that the problem pertains to the two upper floors, so that the ground floor does not have to be considered at all.

Well, it so happened that after

the retreat of the French army through the Pyrenees pass, that nine of the youngest and most comely nuns were found to have disappeared, and it was always believed that they had been captured by the soldiers. Not to distress the mother Superior, however, the nuns who discovered the loss found that it was just possible to conceal the fact, by a judicious manipulation or change of the occupants of the rooms, a maneuver with which they had long been familiar, as when at times it became necessary to conceal the absence of some of their more zealous workers.

So they managed to readjust themselves in such a way, that when the mother Superior made her nightly rounds, every room was found to be occupied; eleven nuns on each of the four sides of the convent; twice as many on the top floor as on the second, and yet the nine nuns were missing. How many nuns were there and how were they arranged?

The merit of the puzzle lies in the paradoxical conditions of the problem, which strikes us at the first blush to be absolutely impossible. Nevertheless it yields so readily to experimental puzzle methods, when one knows there is an answer, that our puzzlists will find it an amusing and instructive lesson.

The Office Boy's Puzzle

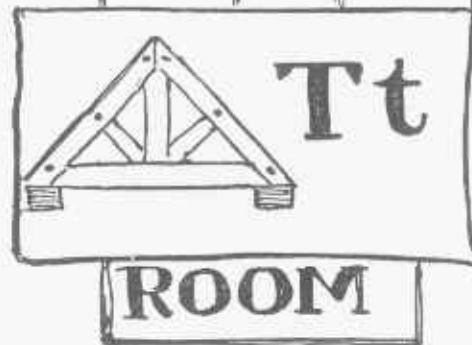

PROPOSITION—Can you decipher the rebus sign on the door of the directors' room?

IT IS NOT GENERALLY known that in the bank, where I worked myself up to the presidency, and made that great financial coup, just before making a Candian tour, I first made my debut as office boy. It was due, it was said, to a phenomenal genius for making a puzzle out of every little thing that came under my notice that it was unanimously voted that some other position should be tendered me.

To illustrate my earnest desire to make everything clear by kindergarten methods, I recall that just before I was promoted, there was a meeting of the directors, and I took occasion to pin an explanatory sign on the door of their room, just to see which of them had brains enough to decipher it. I looked upon it as a sort of competitive test, as it were, to decide which of them was best qualified to fill the position of teller, which was vacant at the time; but, as none of them could

tell, I thought that somebody about my own size was best qualified to fill the position, and therefore used it as a stepping stone to the presidency. Doubtless many of our puzzlists of an older growth will recall the incident and can furnish the answer to such as are ambitious to improve their positions by similar tactics.

What lesson of life can the small boy learn from the fire engine? It must work or it can't play.

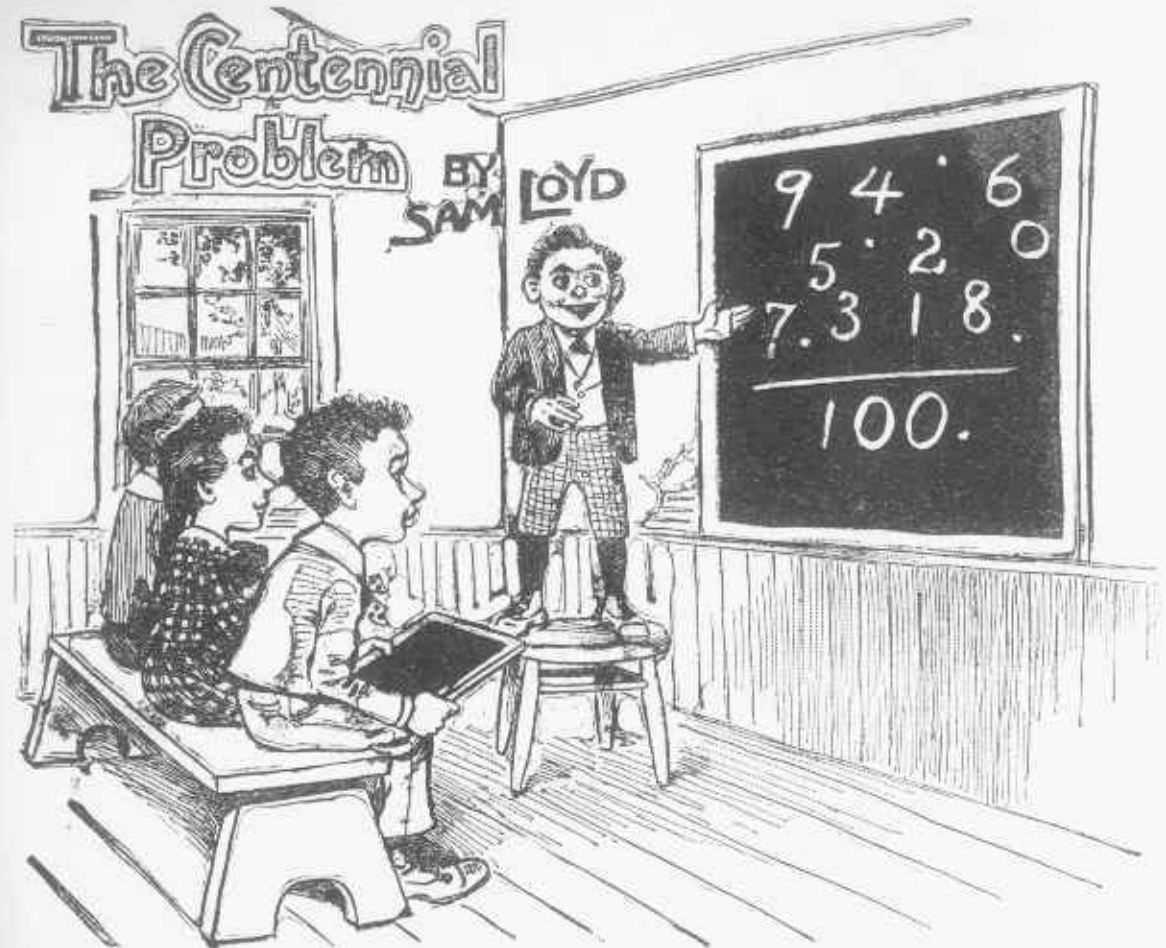

PROPOSITION—Arrange the ten figures, 1, 2, 3, 4, 5, 6, 7, 8, 9, 0 and the four dots so they will add up exactly 100.



OVER A QUARTER OF a century ago, when the centennial of 1776 was duly celebrated in Philadelphia by a grand exposition, I designed a little arithmetical puzzle, which gave rise to considerable discussion. The conditions of the problem, correctly stated, were to arrange the figures 1 2 3 4 5 6 7 8 9 0 and the four dots in such a way that they would add up so as to make exactly 100. The puzzle was quoted and republished all over the world, accompanied by explanations or criticisms so different from those actually expressed and intended that the real answer was never published. Owing to the fact, therefore, that scores of solutions which were supposed to fill the bill, would not fairly satisfy the conditions, I am sure that it will interest such readers to discover wherein they were mistaken, for which reason the terms are again stated: Simply arrange the figures and dots so that by one addition, without the use of signs or numbers

other than those shown on the blackboard, they will make the given answer of 100 correct.

Despite of its apparent simplicity this little puzzle embodies a most scientific mathematical principle which every one should know, and it is now given to introduce or pave the way for a new and interesting class of puzzles, which explains an important and interesting feature, which every teacher and lover of mathematics or even elementary arithmetic should understand.

A Poetical Perplexity.

Here is a clever potpourri of well-known lines to test a person's acquaintance with famous authors:

The curfew tolls the knell of parting day
In every clime, from Lapland to Japan;
To fix one spark of beauty's heavenly ray
The proper study of mankind is man.

Tell, for you can, what is it to be wise,

Sweet Auburn, loveliest village of the plain.

"The Man of Ross," each lispng babe replies,

And drags, at each remove, a lengthening chain.

Ah, who can tell how hard it is to climb

Far as the solar walk or milky way?

Procrastination is the thief of time,
Let Hercules himself do what he may.

'Tis education forms the common mind,

The feast of reason and the flow of soul;

I must be cruel only to be kind,
And waft a sigh from India to the pole.

Sphax! I joy to meet thee thus alone,

Where'er I roam, whatever lands I see;

A youth to fortune and to fame unknown,

In maiden meditation, fancy free.

Multiplication and Addition

By SAM LOYD

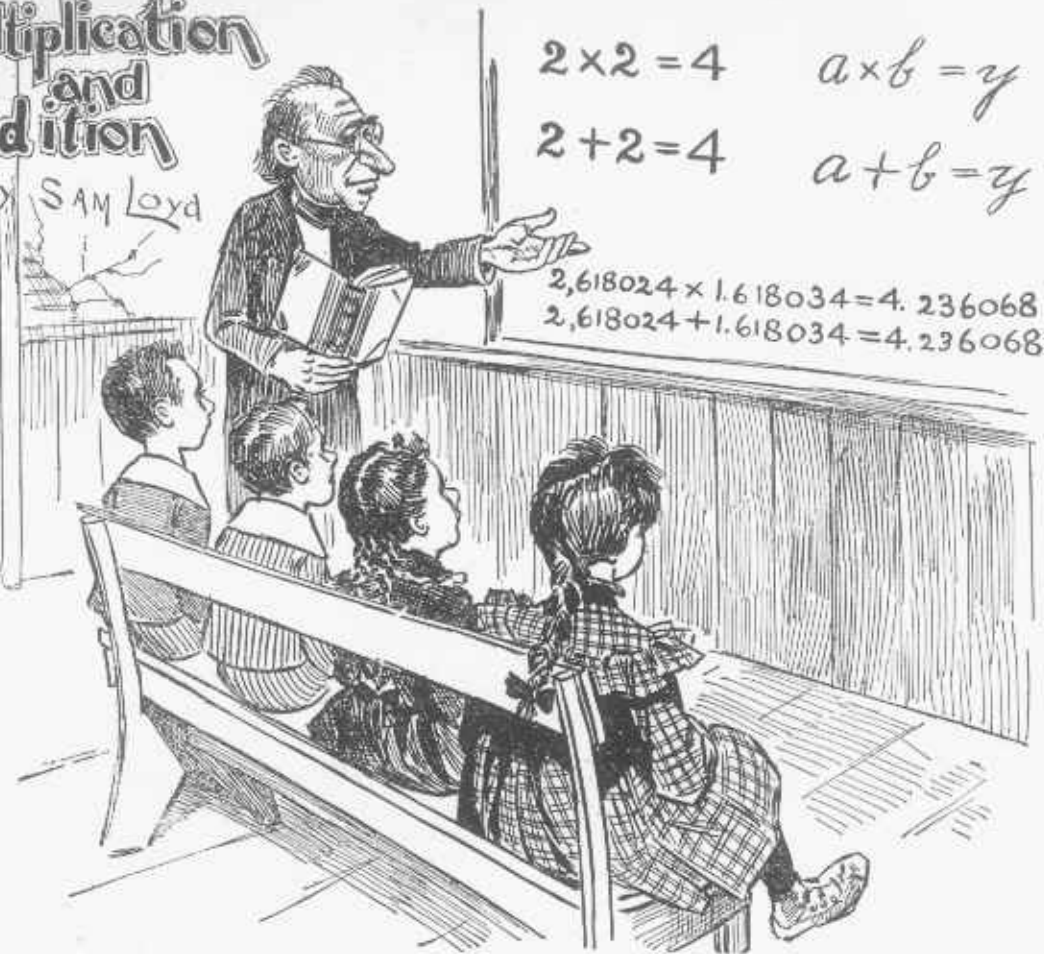

PROPOSITION—Give different values for $A+B$ and $A \times B=Y$



F COURSE YOU ALL understand multiplication and simple addition and do not require pencil and paper to do a little sum like two and two make four, and yet there are peculiarities about the number 2 which many have overlooked.

Well, some time ago the editor of Notes and Queries, who devoted considerable space to the discussion of mathematical questions, gave a very startling reply to a searcher after information, who pointed out the fact of 2 multiplied by 2 producing the same result as 2 added to 2, and asked if there were any other two quantities which when multiplied or added together would give the same result. The editor said that there was one other solution to the proposition where $a+b=y$, and where $a \times b=y$, but by a curious blunder in multiplication said $2.618024 \times 1.618034 = 4.236068$, just as $2.618024 + 1.618034 = 4.236068$.

It is self evident that one of the quantities which we will term a or b

is wrong, and as it is merely a problem in simple addition and multiplication, but is sufficiently out of the ordinary to be confusing, it is presented as a puzzle to correct one of the quantities so that the sum will be equal to the product.

It is really a curious and remarkable fact that there should be any two numbers or series of numbers which when multiplied or added together should give the same result. Calling a 2 and b 2 and y 4 we have shown as an elementary lesson in algebra that $a \times b = y$, just as $a + b = y$, and it is safe to say that it would puzzle many a clever person to think of any other numbers or quantities wherewith to perform the same feat and yet there is such an endless variety that you may select any number or series of numbers by chance and I will at once tell what to add or multiply with to produce similar results.

The rule is extremely simple and well worth knowing, as it proves that 2 is not a freak number as is generally supposed.

Domestic Complications.

Here is a pretty little tangle from the ordinary affairs of life, which the good housewife solved in a minute, but which drove a mathematician to the verge of insanity.

Smith, Jones and Brown were great friends. After Brown's wife died, his niece kept house for him. Smith was also a widower, and lived with his daughter. When Jones got married, he and his wife suggested that they all live together. Each one of the party (male and female) was to contribute \$25.00 on the first of the month for household expenses, and what remained at the end of the month was to be equally divided. The first month's expenses were \$92.00. When the remainder was distributed each received an even number of dollars without fractions. How much money did each receive, and why?



THE Fighting Fishes of Siam

PRIZE PUZZLE BY SAM LOYD



PROPOSITION—Tell how long it will take one species of fish to vanquish the others.



THE PEOPLE OF Siam are natural born gamblers, who would bet their last vestige of clothing upon any event which offers a chance to win or lose. They are not especially belligerent themselves, but they love to witness a fight between any other creature from a toad to an elephant. Dog-fights or cocking mains are of daily occurrence and are conducted pretty much according to the recognized lines of civilized countries, but in no other land upon the globe is it possible to witness a fish fight!

They have two kinds of fish, which, despite of their being very choice food, are raised and valued solely for their fighting qualities. The one is a large white perch, known as the king fish, and the other is the little black carp, or devil fish. Such antipathy exists between these two species of fish that they attack each other on sight and battle to the death.

A kingfish could readily dispose of one or two of the little devilfish, but their methods or tactics are so agile and they work together so harmoniously that three of the little fellows would just equal one of the

big ones, and they would battle for hours without any results. So cleverly and scientifically do they carry on their line of attack that four of the little fellows would kill a large one in just three minutes and five would administer the coup de grace proportionately quicker.

These combinations of adverse forces are so accurate and reliable that the feature of a fish tournament is to calculate upon the exact time it will take a given number of one kind to vanquish a certain number of the enemy.

By way of illustration a problem is presented in simple puzzle form with four of the kingfish opposed to thirteen of the little fighters.

Who should win? And how long should it take one side to annihilate the other?

This problem was presented to me at Bangkok and, while owing to the peculiar complications of the case, it took me quite a long time to figure out the correct solution from a mathematical standpoint, I found that any Malay youth would give the same answer off hand, either by intuition or from knowledge obtained from practical experience. But it is an actual

fact that everyone seemed to know to a second the time required for a certain number of fish to destroy another given number of opponents with but a small margin of deviation contingent upon the better quality of the fishes or the accidental fortunes of war.

Why are married men like steamboats? Because they are sometimes blown up.

What ship contains more people than the "Great Eastern"? Courtship.

Why do women make good post-office clerks? Because they know how to manage the mails (males).

Why is lip-salve like a chaperon? Because it is intended to keep the chaps away.

What is worse than raining cats and dogs? Hailing omnibuses.

Why is an umbrella like a pancake? Because it is seldom seen after Lent.

What is that which every living person has seen, but will never see again? Yesterday.

What is the difference between dead soldiers and repaired garments? The former are dead men, and the latter are mended (dead).

THE FERRY BOAT PROBLEM BY SAM LOYD

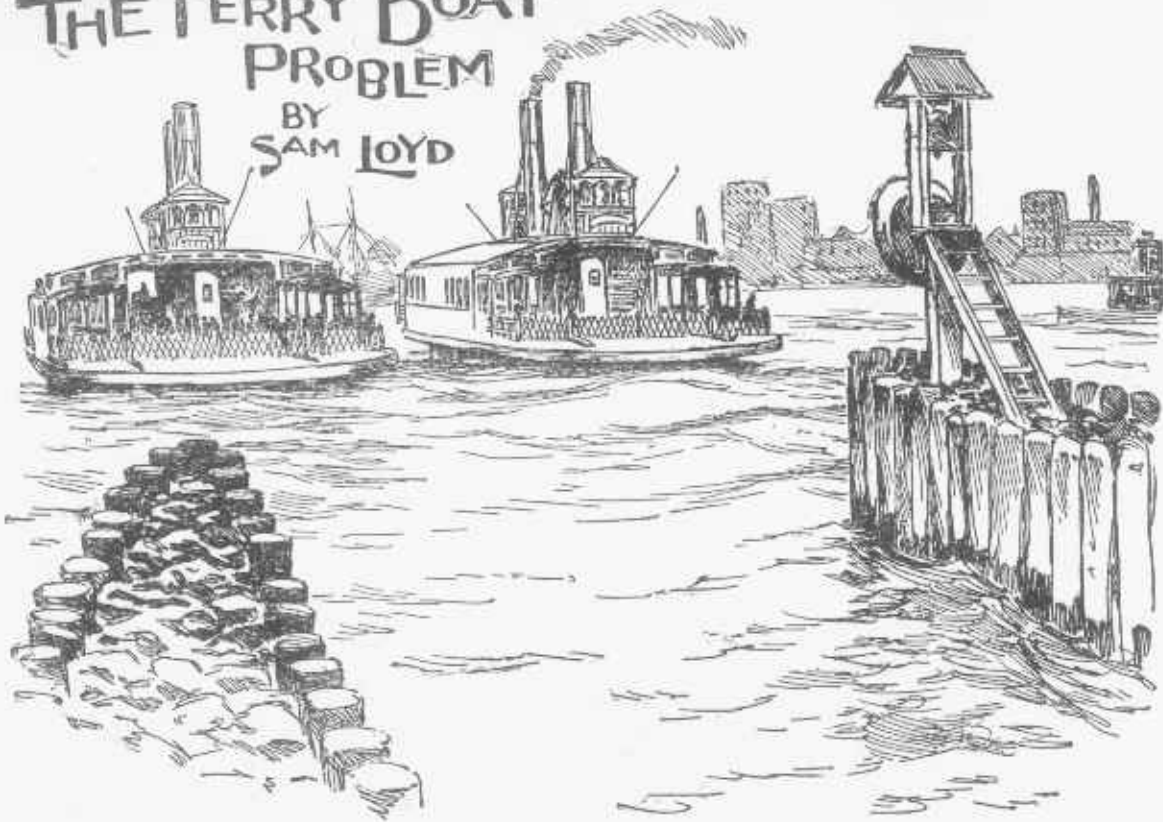

PROPOSITION—Two boats start from opposite sides of a river at the same instant, and meet 720 yards from the shore. They remain in the slips ten minutes, and on the return trip meet 400 yards from the other shore. How wide is the river?

JUST TO SHOW HOW the average mortal follows the cut and dried rules for doing ordinary calculations and will be puzzled by simple problems which call for original lines of thought, attention is called to this practical example which requires only a slight knowledge of the most elementary arithmetic. By a kindergarten process it can be explained in a few minutes so that any child can do it, and yet I hazard the opinion that ninety-nine out of every one hundred of our shrewdest business men would fail to figure it out in a week. So much for learning mathematics by rule instead of common sense which teaches the reason why!

I went to a ferry a short time ago to investigate the relative speeds of two boats, and by calculation evolved the following information: The two ferry boats started from opposite sides of the river at the same instant. One boat, however, was faster than the other, so they met at a point just 720 yards from the shore. Each boat remained but ten minutes in the slip to change

passengers and then started on its return trip, when, by careful calculation, I found that they now met at a point just 400 yards from the other shore.

From the data given, our puzzlers are asked to show a simple way of determining the exact width of the river.

A Parlor Trick.

Robert Heller had the happiest faculty of showing a card trick to its best advantage of any performer I ever met.

Writing the name of a card on a piece of paper, he would fold, without showing or naming, and handing it to one of the spectators, tell him to stow it safely in his vest-pocket.

Let us suppose he has determined to make you choose the deuce of diamonds, which he has written upon the paper. Holding the pack in his hand, he says: "Here are fifty-two cards—twenty-six red and twenty-six black. Which color do you prefer?" If you say black, he throws down the black, and says, "That leaves me the red." But if

you had said red, he would throw down the black cards all the same, and would say, "All right, here are the red." Then he would say, "There are thirteen hearts and thirteen diamonds. Which do you want?" If you say "hearts," he throws them down as before, and says, "I will keep the diamonds," and he would have worked the game as previously described if you had preferred diamonds.

Then he would say, "Here are six cards, and here are seven. Which shall we keep?"

Of course he keeps the six low cards, and dividing again, asks, "Do you select the low cards or the high ones?"

Discarding as before, he places the ace, deuce and tray together and asks, "Which card do you select?"

The second is chosen, and he says, "Look at the paper!" But if the others had been chosen, he would say, with equal effrontery, "All right, that leaves me the deuce. Look at the paper!"

THE POTATO RACE PUZZLE BY SAM LOYD.



IN THE GOOD OLD days of our daddies no country fair was complete without a potato race, and in some localities the pastime, with certain innovations which make it closely allied to a puzzle, is still popular with the rustic lads and lassies. A hundred potatoes are placed on the ground in a straight line, just ten feet apart, which are to be picked up one at a time and placed in a basket which stands ten feet back from the line. Sometimes when two boys compete, the elder or quicker one is handicapped and has to give his opponent the odds of one or more potatoes. In other words, if Harry and Tom compete in a potato race and Tom gives the odds of one potato, Harry has the right to pick up one potato and drop it in the basket before Tom begins.

It is a sufficiently interesting problem for the average mathematician to figure out how far a person has to travel to pick up the hundred potatoes and bring them in one at a time to the basket. That is one of grand father's old-time puzzles, with which we are all so familiar that in place of being caught by guessing a

distance which is miles too short, the modern puzzler is apt to give an estimate many miles too long. There is a simple rule for solving problems of this kind, so we will also ask our young students to calculate how far the lad must travel to pick up 100 potatoes placed 10 feet apart and carry them one at a time to the basket placed ten feet back?

The real potato race puzzle, however, which will tax the cleverness of our solvers turns upon the relative speed of two lads and the question of handicapping by giving the odds of one potato.

Now, in the present case the lads are very evenly matched, nevertheless, as it was found that Tom was 2.04 per cent. quicker than Harry, it was agreed that he should give him the odds of just one potato! So, in order to win the race, Tom, who moves 2.04 the quickest, must bring in fifty potatoes before Harry can get his forty-nine. The sketch shows Harry dropping in the potato which he has selected out of the 100, which starts the race.

It will be found that the result of the race varies according to which one of the potatoes Harry elects to receive for his handicap. The sec-

ond and more difficult proposition, therefore, is for you to tell the exact result of the race if Harry selects the most favorable potato, always remembering that Tom runs 2.04 per cent. the faster.

Deeply Injured.

Her eyes were wild, her hair was in disorder, her face was flushed, her hands were clenched. She was a deeply injured, desperate woman.

"Oh, cruel one," she cried, in anguished tones, "I have borne with you too long! You have injured the very foundations of my being. Day by day you have tortured me, and yet I could not bear to give you up. When first we met, how your ease and polish attracted me! When you became my own, how many friends envied me! Yet your understanding is too small for my large soul. You are opposed to my advancing myself. You have ruined my standing in society. If we had never met I might have walked in peace. So begone. We part forever!"

There was a moment's convulsive breathing, a gritting of teeth and a sharp sigh. It was all over. By a supreme effort she had removed her —?

THE MOVING DAY PUZZLE

BY
SAM LOYD.



PROPOSITION—In how few moves can you transpose the position of the whisky flask and the scrubbing brush.

THERE IS A PRETTY little study, presented as a seasonable souvenir for the consideration of the rank and file of veterans who will march on May Day to new quarters.

The sketch shows a migratory couple, who, having had their worldly belongings landed by contract into their cozy little six-room flat, have been wrestling for several hours with the domestic 14-15 block puzzle. They have five large articles, the bedstead, table, sofa, ice box and bureau, which are so bulky that no two can be placed in any one room at the same time on account of the close packing of the other small articles, which minor belongings, however, need not be mentioned, as pertaining to the problem.

It so happens, however, that the ice box and the bedstead were placed by the furniture wreckers in the wrong rooms, and the man and his good wife have been struggling for several hours to transpose them.

Being one of the many who solved my old 14-15 puzzle, the man has marked out a diagram of his flat on the table, with the connecting doors as shown, and has placed five articles on the squares to represent the pieces which are to be moved.

It is only necessary to mention that the whisky flask represents the bedstead and the scrubbing brush may be taken for the ice box, and that you are to transpose the positions of these two articles by moving one piece at a time in a sequence of plays in which the flat-iron, pepper box and mouse trap may be used to advantage.

Of course there are a thousand and one ways of performing this simple trick, but on Benjamin Franklin's well-known axiom that "three moves are as bad as a fire," the feat must be performed in the fewest possible number of moves, and as there is never more than one vacant square to move to, correspondents or others who wish to record their answers can write out the same as concisely as possible by merely mentioning the article moved, viz: "I perform the feat in thirty moves, as follows: Whisky flask, scrubbing brush, flat iron, mouse trap, etc., etc. Solve the puzzle by the use of small pieces of paper for counters placed on the diagram of the flat.

Why is a book your best friend and companion? Because when it bores you can shut it up without giving offense.

Why is playing chess a more re-

putable occupation than playing cards? Because you play chess with two bishops, and cards with four knaves.

When may ladies who are enjoying themselves be said to look wretched? When at the opera, as then they are in tiers.

Why should a minister be believed? Because he is nearly always accurate (a curate).

Why is a mad bull like a man of convivial disposition? Because he offers a horn to everybody he meets.

What should be looked into? A mirror.

Why is the map of Turkey in Europe like a frying pan? Because it has Greece on the bottom.

How many young ladies does it take to reach from New York to Philadelphia? About one hundred, because a miss is as good as a mile.

Why should a colt avoid exposure? Because it might take cold and become a little horse (hoarse).

In what respect is matrimony a game of cards? Why, a woman has a heart, a man takes it with a diamond, and after that her hand is his.

What word of one syllable, if you take two letters from it, becomes a word of two syllables? Plague ague.

THE PLUMBER'S PROBLEM

BY
SAM LOYD

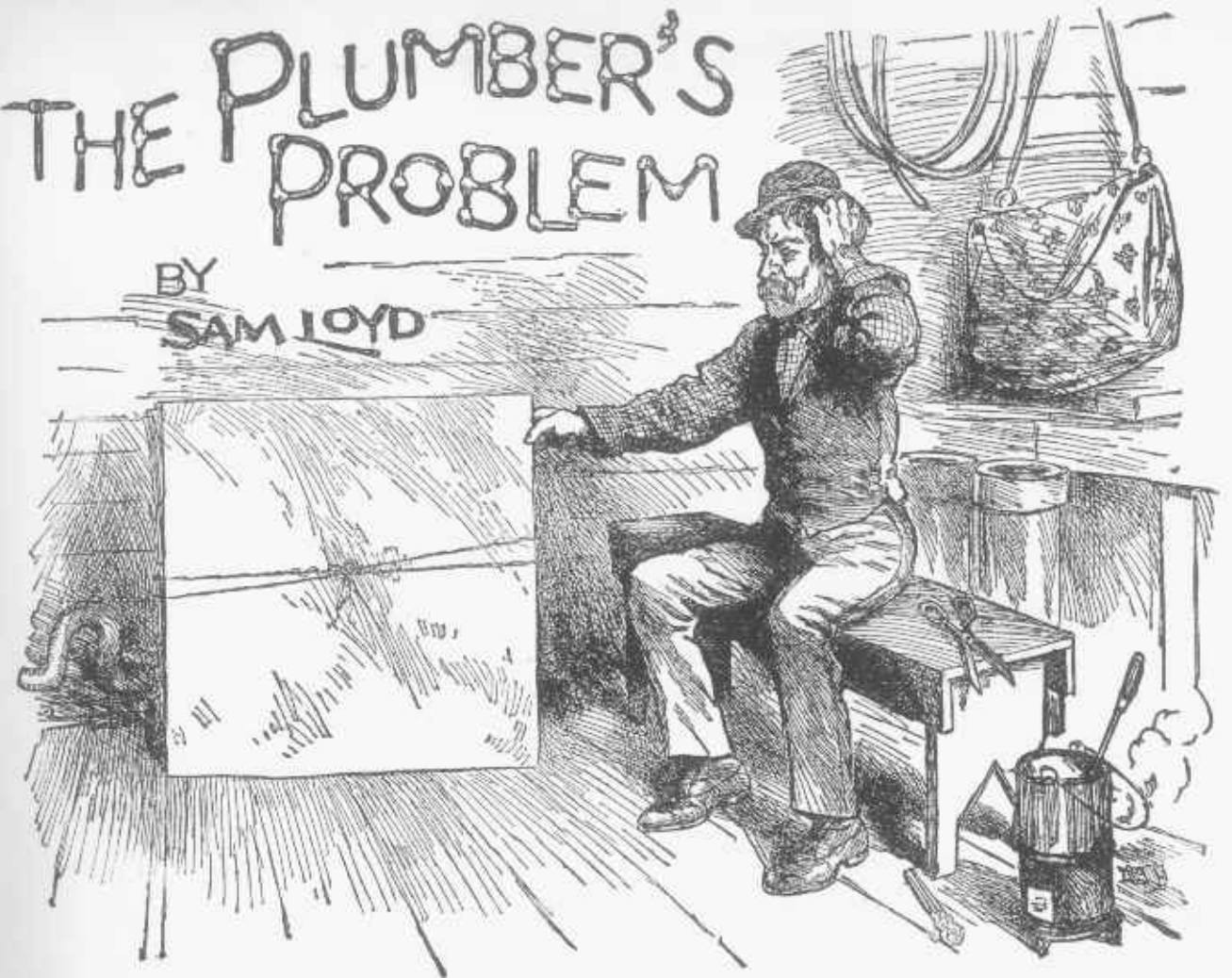

PROPOSITION—What is the most economical form of a tank designed to hold 1000 cubic feet?

THERE IS A PRACTICAL plumbing lesson which will interest those of a mechanical turn of mind. Plumbers, boiler-makers and tank builders estimate in cubic feet, reckoning seven and a half gallons to the cubic foot, which is close enough for all practical purposes. Of course a mathematician would tell us that there are 1,728 cubic in. to a cubic foot, because $12 \times 12 \times 12 = 1,728$, while to seven and one-half gallons there are 1,732½, but then plumbers are a liberal set of fellows who cheerfully throw in the extra four and a half inches. A plumber wanted to estimate the lowest possible cost of a copper tank to hold 1,000 cubic feet. Copper comes in sheets three feet square, worth \$1.00 per square foot, so the problem is to determine the most economical dimensions of a square tank capable of holding 1,000 cubic feet.

It is self evident that if the bottom of the copper tank is ten feet square, 10 multiplied by 10 gives 100 as the area of the bottom, which multiplied by 10 for the depth, gives the correct dimensions of a tank which will hold 1,000 cubic feet.

Mathematically speaking, 10 is here shown to be the cube root of 1,000, and by reversing the proposition we get a clear understanding of what is known as the square and cube of a number. A number multiplied by itself gives its square or 2nd power, like 10 multiplied by 10 equals 100; while if we multiply it once more by the first power, viz: 10 multiplied by 100, we get the cube or third power. The third power is always a perfect cube, but when we multiply it again by 10, which would make 10,000, we have raised the product to the fourth power, and may continue with the fifth, sixth, seventh, etc.,

A cube ten feet square will hold 1,000 cubic feet it is true, but as that would require 500 feet of copper, (100 on the bottom and each of the four sides) it shows that the real point of our problem is to determine the most economical form of a tank: viz: to hold 1,000 gallons and use the least possible amount of copper.

It is a simple every-day piece of shop work which any mechanic would tackle in a way satisfactory to himself, but which a mathematician will discover involves "the duplication of the cube" which has baffled the world for countless centuries.

The "unsolved problem of the duplication of a cube" is to give the dimensions of a cube twice as large as another, viz.: If a cube ten feet square contains 1,000 cubic feet, what would be the size of a cube containing 2,000 cubic feet?

TELL MOTHER'S AGE

PROBLEM
BY
SAM LOYD.



PROPOSITION—The ages of the three amount to 70 years and the father is just six times as old as the boy. When their combined ages amount to twice 70 years the father will be only twice as old as the boy. What is the age of the mother?

AGE PUZZLES, AS they are termed, are always interesting, and possess a certain fascination for the young folks who are at all mathematically inclined. As a rule, they are extremely simple, but in the present case the data is so meagre, and the proposition so different from what is expected, that the query actually appears startling.

It was sprung in the family circle the other day, and gave rise to a discussion which taxed the mathematical ingenuity of all present to the full limit.

One of the trio as represented in the picture was having a birthday anniversary, which aroused Master Tommy's curiosity regarding their respective ages, and in response to his queries his father said:

"Now, Tommy, our three ages combined amount to just 70 years,

and, as I am just six times as old as you are now, it may be said that when I am but twice as old as you, our three combined ages will be twice what they are at present. Now let me see if you can tell me how old is mother?"

Tommy, being bright at figures, readily solved the problem, but then he had the advantage of knowing his own age, and could guess pretty closely to the ages of the others. Our puzzlists, however, have merely the data regarding the comparative ages of the father and son, followed by the startling proposition as to "how old is mother?"

A man had twenty-six (twenty sick) sheep and one died, how many remained? Nineteen.

Why is it easy to break into an old man's house? Because his gait (gate) is broken and his locks are few.

Where can one always find happiness? In the dictionary.

When will there be but twenty-five letters in the alphabet? When U and I are one.

What was Joan of Arc made of? Maid of Orleans.

I went out walking one day and met three beggars; to the first I gave ten cents, to the second I also gave ten cents, and to the third I gave but five—what time of day was it? A quarter to three.

What is that which by losing an eye has nothing left but a nose? Noise.

What is that which is full of holes and yet holds water? A sponge.

What is that which is put on the table and cut, but is never eaten. A pack of cards.

How can you by changing the pronunciation of a word turn mirth into crime? By making man's laughter manslaughter.



A DAISY
PUZZLE GAME
BY SAM LOYD.

REFERRING TO THAT oft-repeated query as to the origin of certain puzzles, occasion is taken to say that I have fashioned quiet a number of Swiss puzzles, from flags to Sweitzerkase and Alpine roses, and believe my penchant in that direction may be traced to a little incident which occurred over a quarter of a century ago.

With a party of tourists who were doing the Alps in the summer of '65, and who had undertaken the long tramp over the snows from Altdorf to Fluellen, to see the historic spot where Tell used to shoot apples, we were enjoying a rest, after a long day's journey, when spying a little peasant girl gathering daisies, and, thinking to amuse the child, I showed her how to prognosticate her matrimonial future, by plucking off the petals of the flower to determine whether she would be a bride of the "rich man, poor man, beggar man or thief." She said that the sport was well known to the country lassies, with the slight difference that a player was always at liberty to pluck a single petal or any two

contiguous ones, so that the game would continue by singles or doubles until the victorious one took the last leaf and left the "stump" called the "old maid" with your opponent.

To our intense astonishment the pretty madchen, who could not have been more than ten years of age vanquished our entire party by winning every game, no matter who played first.

I did not study out the trick until we were back in Luzerne, but I was so bantered by the party that I made quite a point of investigating it, but never had the satisfaction of beating the little mathematician at her own game. I will say, incidentally, however, that I returned to Altdorf some years later and visited the locality of my previous defeat, and it would give me pleasure and add to the romance of the story if I could say that I found little Gretchen developed into a beautiful mountain fraulein, with a phenomenal mathematical bent. I doubtless saw her, however, for the entire female population of the little dorf was preparing to sow the fall crops. They were all prematurely old and exactly alike, and I

imagined I recognized my former friend harnessed up with a cow to a plow, which was guided through the rocky soil by her noble husband.

The game is shown in the picture in the form of the daisy, and is played by two persons, who in turn cover the petals by placing upon them small markers, until all are covered. The one who covers the last petal wins, leaving the old "maid" stump to his opponent.

It is evident that the one who begins a game must lead off by covering one or two leaves, so the puzzle question which you are to answer is to tell the best replies in case he begins with one or two leaves, and incidentally to discover the winning system or principle which the little Swiss maiden worked so successfully.

Why is a nobleman like a book? Because he has a title.

What class of women are most apt to give tone to society? The belles.

Why is a very amusing man like a bad shot? Because he keeps the game alive.

Where are two heads better than one? In a barrel.



PROPOSITION—Tell which one of the players should pay for the game.

THERE ARE PUZZLES or problems connected with almost all kinds of games, either in the play itself or in the manner of scoring a victory. Now, it is safe to assume that every one knows more or less about fifteen-ball pool. Nevertheless, here is a little problem which does not call for a practical demonstration with the cue, so our puzzlists will have just as good a chance for the prizes offered for the answers as the most skillful experts.

There are fifteen balls to be pocketed, and according to custom, the one who pockets the least number of balls must pay for the game.

Well, three players were starting a game the other day, and No. 1 who was an expert, agreed to pocket as many balls as players No. 2 and No. 3 both together. Just as they were going to start a fourth man came in and joined them, but, as he was a stranger, he did not receive any handicap odds and played on even terms with each of the other three players.

The rack shows the number of balls which each man made during the play, and a discussion then ensued as to who was the loser.

The puzzle is to tell which one of the players should pay for the game according to the terms of the agreement. That the problem is not so simple as it looks may be inferred from the fact of its having been referred to the competitors in a recent championship pool tournament where it was found that no two of the players agreed upon the same answer. Tell which one should pay for the game, and why.

Notes and Queries.

Among the curious questions which find their way into the puzzler's sanctum is the following, which, although not intended as a puzzle, is worth a passing notice as illustrating some of the queer things we are expected to know: "Suppose that three generations of fathers and sons, with the names of all three alike, were residing together, and you wished to send a

letter to the third generation, how would you address it?"

Answer: This problem should not cause sleepless nights or needless worry, as a letter addressed to "John Smith the Youngest" would meet the requirements of society and reach its proper destination.

But supposing the communication related to the following business transaction, then the problem would require more careful consideration. The writer had seen that invaluable article known as the "tailor's goose," and knowing that Mr. John Smith manufactured the same, desired to purchase two of them. How should he write his order—"Send me two Tailor's Geese," or "Send me two 'Tailor's Geese.'"

Or would it be considered a "give away" to dodge the issue by saying, "I want a Tailor's Goose, but you may as well send me two of them."

Why are bells the most obedient of inanimate things? Because they make a noise whenever they are told.

FREE ACRES

A squatter problem?
BY SAM LOYD.

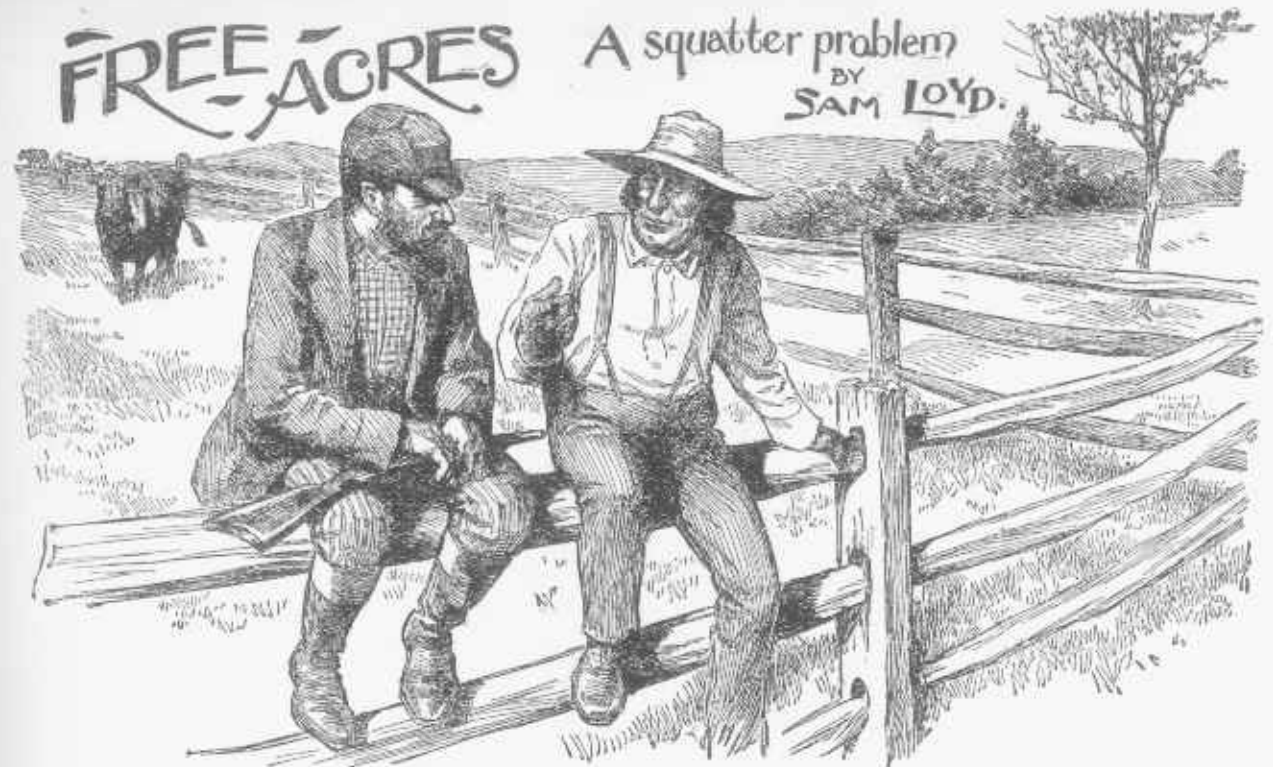

PROPOSITION—How can you enclose as many acres of land as there are twelve-foot rails to a fence?



THERE IS A PRETTY puzzle from the Lone Star State, introducing a famous old problem and a bit of American history with which many of our readers are doubtless familiar. Texas was practically settled, or rather overrun, by the Americans as far back as 1830, but it was not until the end of fifteen years of fighting with the Mexicans and Indians that it was admitted into the Union, and it was shortly after that date that the famous squatter law was introduced which gave a settler free all the land he would inclose or cultivate within a year from the time of taking possession. Some of the early settlers had pretty hard times with the Indians, greasers and bears, but the descendants of such as managed to "stick it out," as they termed it, now rank among the great cattle kings of the world, and, according to an official report just issued during the past month, it will soon develop that some of the most wealthy landed proprietors of the world will be found to be Indians. Among the great ranches of the West, whose owners would not be appalled by the size of the flocks of the "white bulls and the dappled bulls which grazed on the plains of Sicily" as grandiloquently described by Archi-

medes, may be mentioned the comfortable ranch of Texas Pete, a half-breed Indian, who was among the first to take up land under the squatter act which gave him the ownership of all the land he could inclose or cultivate within one year.

According to his own story, and he is still a hale and hearty man, although well beyond the three score years and ten allotment, he says his wife was the better man of the two in staking out their claim. The understanding, as he explains it, was that they were to get free all the land they could inclose with a three-rail fence within twelve months, so for one whole year he and his wife were putting up this fence, which inclosed an immense tract of land, which they afterward cultivated or turned into great pasture fields which eventually became filled with flocks of sheep and cattle.

From this story we deduct the following curious problem: Let us suppose that the tract of land is exactly square and is inclosed by a three-rail fence, as shown in the sketch, and that each rail is exactly twelve feet long. Now, then supposing that there are just as many acres inclosed as there are rails in the entire fence. How many acres of land has Texas Pete got in his great cattle ranch?

Who may marry many a wife and still be single all his life? A clergyman.

Why is a plum-pudding like the ocean? Because it contains many currants.

Of what trade is a minister at a wedding? A joiner.

What three misses are those whose days are always unlucky? Mis-chance, mis-fortune and mis-hap.

What miss is always making blunders? Mistake.

What misses are of a very jealous tempers? Mis-give and mis-trust.

Why is an umbrella a paradox? Because it is best when used up.

When does the shoemaker display wonderful powers of endurance? When he holds on to the last.

What part of the face resembles a schoolmaster? The eyelid, because it always has a pupil under the lash.

At what time of life may a man be said to belong so the vegetable kingdom? When long experience has made him sage.

Which is the gayest letter in the alphabet? U, because it is always in fun.

When is a very angry man like a clock fifty-nine minutes past twelve? When he is just going to strike one.



PROPOSITION—Tell how much money each of the men had when they commenced to play.



HAVE ALWAYS found the young folks to be particularly clever at all manner of tricks with coins, so here is one which will please them, and at the same time make them more familiar with our United States money.

Three Milwaukee Dutchmen played pinochle for two days without stopping, and when they adjourned it was found that Claus had won just 8 cents and his brother Karl 22 cents. The problem which I want the young folks to find out is to prove just how much money the other fellow, Heindrichs, had when the play ended, for, as you see in the picture, each has just two coins, and those six coins, which are worth a total of just \$3, represent all the money belonging to the party. It is to be assumed that the money that they now have is all that they had when they started the play, so that the score for beer and pipe, which must be settled for, does not pertain to the problem.

How They Made Love in Puzzledom.

Here is a little story told in verse which should greatly interest our sweet young women puzzlists:

He dwelt in Massachusetts,
An she in Muscatine;
And they liked the "Puzle Corner"
Of the Hogwash Magazine.

She could reverse, eviscerate,
And syncopate a word,
Add two-fifths of a famous man
And find a common bird,

And the thing whose 8, 4, 1
Was a flower, and 6, 7, 2,
11, 9, 6, 3, 14, 4
An antique city knew.

She used to send solutions in
And signed them "Dimple Dew,"
While he successful answers gave
As "Montfort Montague."

Cupid o'er Massachusetts flew,
And over Muscatine,
And fed the flame that gradual grew
With the Hogwash Magazine.

Until one day the editor
Offered a handsome pize
For those who 'tween his 2d and 1st.
His third could recognize.

"Dimple Dew" and "Montague"
The sole replies sent in;
She got an oroide penhandle,
He an Alaska pin.

Their names upon the "Roll of Fame"

Were printed side by side;
He from the editor got her name
And he claimed her for his bride.

"Oh, be my first," he wrote, "and I
'My second' and my third,
And my sixteenth, and finally
Henceforth shall deem absurd."

And she wrote by return of post:
"Decapitate a glove,
Prefix an orb and add a sheep
And let that tell my love."

He packed his carpet 2, 1, 7,
And went to Muscatine,
They wedded there and took a file
Of the Hogwash Magazine.

And spent a rapturous honeymoon
As blythe as joyous birds,
And found their second was their first

And 8, 6, 3 and 4 was thirst
And syncopating words.

Why is a buckwheat-cake like a caterpillar? Because it is a kind of grub that it makes the butterfly.

What is that which has neither flesh nor bone, yet has four fingers and a thumb? A glove.

Barnum drove a ten-in-hand through New York city, and his horses had only twenty-four feet among them; how was that? They had twenty fore feet.

When is the sun a mechanic? When it is a Mason (May sun).

Of what trade are all the Presidents of the United States? Cabinet-makers.

THE PUZZLE OF THE DUTCHMEN AND THEIR WIVES



PROPOSITION—Guess the names of the men and their wives.

SOME OF THE OLD Dutch customs are yet preserved of trading cattle, poultry and farm products in odd numbers and quantities pertaining to each variety, such as to buy eggs by the score, some things by the dozen, others by bushel, peck or small measure, sugar by the three and half pounds, etc., etc.

This custom explains a curious old problem, published a couple of centuries ago in a unique collection of anecdotes of old Manhattan, with which many are familiar, but which for apparent lack of perspicuity has caused its meaning to be questioned.

In the language of this quaint old volume, it says: "There came three Dutchmen of my acquaintance to see me, who, being recently married, brought their wives with them. The men's names were Hendrick, Claas and Cornelius, the women's Geertring, Catrun and Anna, but I forgot the name of each man's wife. Well, they told me that they had been to market buying hogs, each person buying as many hogs as they gave shillings for one hog. Hendrick bought 23 hogs more than Catrun, and Claas bought 11 more than Geertring. Likewise they said that each man laid out three guineas more than his wife. Now, what I want to know

is whether it is possible from this description of their purchases to tell the names of each man's wife?"

The inference was that the merry party got so befuddled over their beer and schnapps that they could not tell just who was who, so the worthy landlord finds himself compelled to sort out the different couples properly, by a process of extracting the square roots of the hogs; the squares of the money and the squares of the men and their wives!

It is a curious problem which yields readily to experimental puzzle methods, so everyone is expected to solve it.



Guessing-Match

A guessing-match about cats is entertaining. Write out the following list for each competitor without giving the answers, which are here printed in parentheses, and the ones guessing the largest number wins:

- An aspiring cat (catamount).
- A cat that can swim (catfish).
- A cat that can fly (cat-bird).
- A cat that will be a butterfly (caterpillar).

- A cat's near relations (catkin).
- A horned cat (cattle).
- A cat that throws stones (cata-pult).
- A tree cat (catalpa).
- A water cat (cataract).
- A cat that flavors the grapes (Catawba).
- A cat that covers acres of grounds (cataclysm).
- A subterranean cat (catacomb).
- A cat that, living, appears dead (catalepsy).
- A cat prized as a gem (cat's-eye).
- A cat with a cold (catarrh).
- A cat that is good to eat (catch-up).
- A cat that asks questions (catechism).
- A library cat (catalogue).
- A dangerous cat (catastrophe).

Why would it be impossible to starve in the desert of Sahara? Because of the sand which is (sandwiches) there.

How did the sandwiches get there? When Ham was sent there with his followers, who were bred (bread) and mustered there.

Why can you never expect a fisherman so be generous? Because his business makes him sell fish.

Why was a defeated candidate after the late election, like the earth? Because he was flattened at the poles.

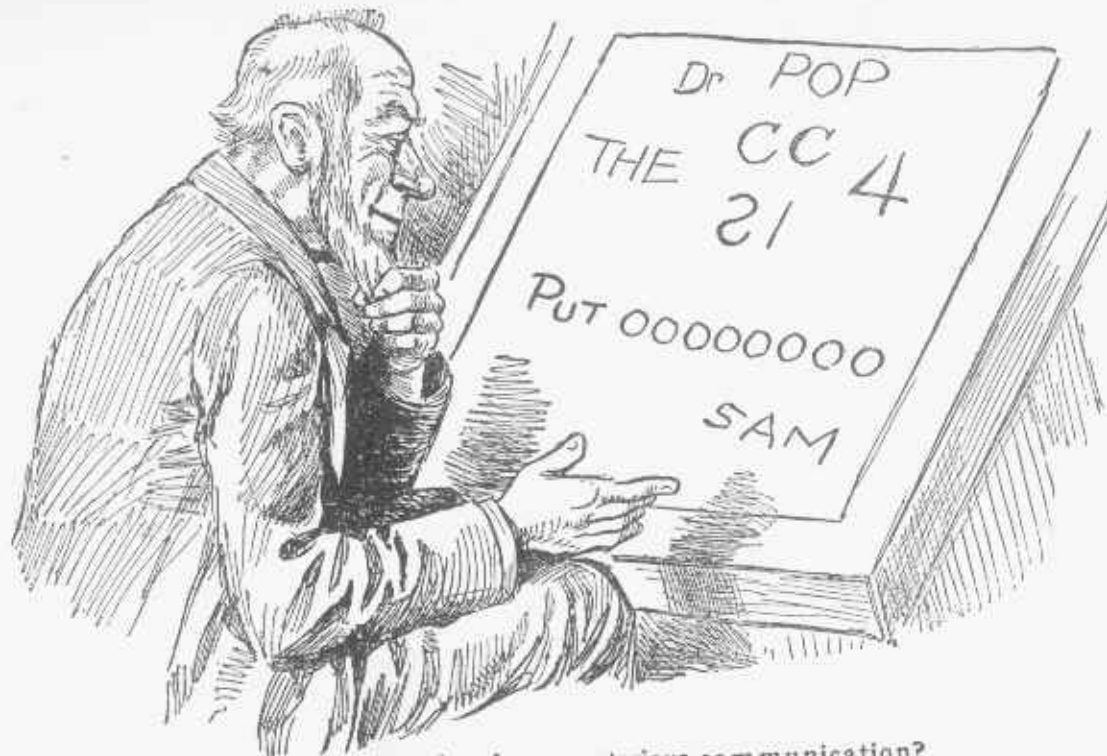

PROPOSITION—Can you decipher the above mysterious communication?

I HAVE JUST RECEIVED a puzzling communication from that boy of mine, who is studying at an agricultural college in New Jersey, and the reading of the same has bothered me and Mandy considerably. He is making great progress he tells us, nevertheless, some of his reports are so mysterious and baffling that I am compelled to ask the assistance of our clever puzzlists to decipher this one. It strikes me as being what in the old days we used to term a rebus puzzle, which conceals some sort of a cryptographic message or other, which can be guessed or read, if you are smart enough to master it.

He has such funny ways of writing everything that he keeps his friends guessing all the time. He wrote Utica, UTK and Tennessee XEC, and Ohio he described as oO, although by transposing them to Oo he says it means owe nothing, all of which is mentioned to assist you in deciphering his cryptographic letter, so, if you have XAIOOT you will find his XAIOOT meaning.

All of which is suggested by Dr. Whewell's letter to a young lady. "You O a O, but I O thee, O, O no O, but O, O me, & O, let my O no O go. But give OO I O you so!"

The Great Diamond Robbery.

In one of Dumas' narratives of noted criminals mention is made of a certain jeweler of the Rue Faubourg St. Honore, who during a long career of crime had robbed many ladies of distinction of their finest gems, either by substituting imitations or by changing the positions of the stones so that their abstractions would not be detected.

To illustrate the clever rascal's mode of procedure let us look at the accompanying antique pin containing twenty-five diamonds. The lady who owned it had been accustomed to count down from the top and branch out from the centre, right, left or down so as to always count thirteen.

She had this particular piece of jewelry repaired by the noted criminal referred to, and remembered showing her method of counting the diamonds, which the polite jeweler again called her attention to when returning the same. For many years afterwards she continued to count them in the same way, always finding the thirteen to be correct as before, and yet two of the finest gems had been purloined! How did the ingenious thief conceal the crime?

Here is a sketch of the antique pin with the twenty-five diamonds

as it was when the jeweler received it:

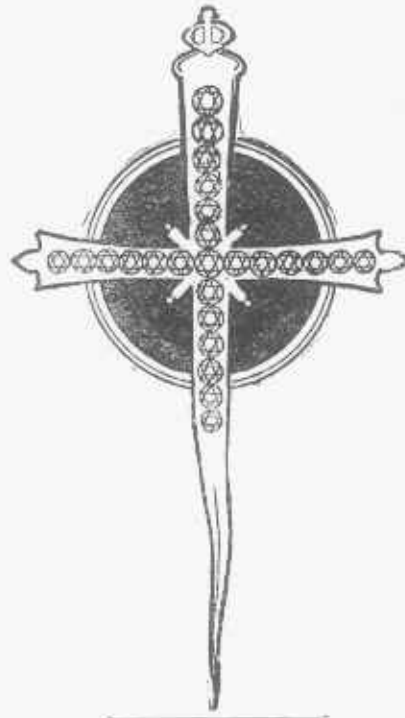

Why is a man who never bets as bad as a gambler? Because he is no better (better).

Why is the root of the tongue like a dejected man? Because it's down in the mouth.

What is that which we often return, but never borrow? Thanks.



PROPOSITION—If the water lily is ten inches above the water, and disappears under the surface at a point distant twenty-one inches, what is the depth of the lake?

THE POET LONGFELLOW was a fine mathematician who often spoke about the advantage of clothing our mathematical problems in such attractive or congenial garb as would appeal to the fancy of the student in place of following the dry, technical language of the textbooks. He would connect the proposition with some familiar subject which best explains the problems to be solved.

A clever kindergarten illustration of a mathematical theorem leaves a clearer and more lasting impression upon the mind of a student than a whole term of uncongenial study.

He always held mathematics to be the most important branch of knowledge taught in our colleges and high schools, for the reason that it enters so largely into all of the arts and sciences, and yet the average student graduates with such an undying aversion to figures that he speedily dismisses all recollections of them from his mind.

The water lily problem is one of several introduced in Longfellow's "Kavanah," written while occupying the Chair of Modern Languages in Harvard University, 1849. It is so simple that anyone, even

without a knowledge of mathematics or geometry, could solve it with a pair of compasses or rule, and yet it illustrates an important geometrical truth in a never-to-be-forgotten way, which many graduates have never grasped at all.

I forget the exact language of the problem, as he described it to me personally during a discussion of the subject, but he told of a water lily growing in a lake; the flower was one span above the surface of the water, and when swayed by the breeze would touch the surface at a distance of two cubits, from which data it was desired to compute the depth of the lake.

Now, let us suppose, as shown in the sketch, that the water lily is ten inches above the surface of the water, and that if it were pulled over to one side it would disappear under the surface at a point distant twenty-one inches from where it now stands, say just where the young lady is supposed to have drawn it, which shows that the two flowers are anchored to the same root at the bottom of the lake, what is the depth of the water?

To Tell a Person's Age.

This method is the easiest and best one known. Let the person whose age is to be discovered do

the figuring. Suppose, for example, a girl is 13 and was born in November, put down the number of the month. (November is the eleventh month.)

	11
Multiply by 2.....	2
	22
Add 5.....	5
	27
Multiply by 50.....	50
	1350
Add age (13).....	13
	1363
Subtract 365.....	365
	998
Add 115.....	115
	1113

As she answers 1113, tell her her age is 13 and November is her birth month. This test never fails up to 100. In computing ages under 10, a cipher will appear prefixed in the result, but no notice is taken of it.

Why would an owl be offended at your calling him a pheasant? Because you would be making game of him.

THE MISSING NUMBER



PROPOSITION---Arrange the nine digits and a cipher in two rows so that they will add up correctly as shown.



HE CHINESE ARE wonderfully expert at figures, although in some way or other they seem to do everything backwards, just as they do in their reading which always goes uphill. They seemingly do their multiplication by division, and addition by subtraction.

They are very clever at mental arithmetic and do some queer calculations by rules or tricks which they cannot or will not explain.

One of their professors showed me some exercises in addition, which in their own peculiar way he reversed so as to do it by subtraction and working backwards from the answer to get the figures which were added together.

He asked me to arrange the nine digits, 1, 2, 3, 4, 5, 6, 7, 8, 9, and a cipher in two rows, add them together and rub out the two rows and any two figures I liked from the sum, and he would restore them at once. It appeared to be a simple, but pretty feat, so I present it to our puzzlists and ask them to replace the ten missing digits, although the real puzzle is simply to tell what are the erased numbers taken from the answer.

Missing-Word Anagram.

Here is a clever missing-word puzzle. Use a four-letter word, the same letters each time, in each of the blank spaces, and make good sense of the following rhyme:

A _____ old woman on _____ bent
Put on her _____ and away she went;
_____ she cried, as she went on her way.
How are we going to _____ to-day?

Why is a glass-blower the most likely person to set the alphabet off at a gallop? Because he can make a D-canter.

What letter in the Dutch alphabet will name an English lady of title? A Dutch—S.

What Christian names besides Anna, reads the same both ways? Hannah or Eve.

When you stole my first, I lost my second, and you are the only person to give me my whole.

Hearts-ease.

Why is a bridegroom often more expensive than a bride? Because the bride is given away, but the bridegroom is often sold.



THE FAMOUS HOT CROSS BUN PUZZLE

PROPOSITION---Tell how many children there were and how many hot cross buns each received.



HERE IS A TIMELY souvenir calculated to interest such philosophers as have been delving into the hidden meanings of Mother Goose's quaint rhymes, for as a matter of fact most of those jingling old melodies conceal riddles or puzzles which are really worthy the investigation of us children of a larger growth. Now, just listen to the cry of the Hot Cross-Bun man:

"Hot-cross buns, hot-cross buns,
One a penny, two a penny,
Hot-cross buns.
If your daughters don't like them
Give them to your sons!
Two a penny, three a penny,
Hot-cross buns.
I had as many daughters
As I had sons,

So I gave them seven pennies
To buy their hot-cross buns."

The inference is clear that there are three sizes of buns—one for a penny, two for a penny and three for a penny. There were just as many boys as girls, and they were given seven pennies so as to treat each one alike. How many buns did each receive?

Put Eleven Men in Ten Beds.

Every now and then some correspondent, probably a hotel keeper in search of practical information asks for an explanation of the following perplexing proposition:

An innkeeper had a sudden influx of guests, eleven arriving in one party and demanding separate beds. The host had only ten beds at his disposal, but he notwithstanding

managed to accommodate them as follows: He put two in the first bed, with the understanding that the second should have a bed to himself in a few minutes as soon as the others were settled. He then put the third in the second bed, the fourth in the third bed, and so on the tenth being accommodated in the ninth bed. He had thus one bed still left, which the eleventh man, who was temporarily placed in the first bed, was now invited to occupy.

As a matter of course this problem is not supposed to be susceptible of a rigid mathematical demonstration. It is based on a paradoxical proposition, but the error is so cleverly concealed that it is liable to avoid detection. That is all there is to it.

Why is a room full of married folks like a room empty? Because there is not a single person in it.

How many wives are you allowed by the Prayer-book? Sixteen: viz. fo(u)r better, 4 worse, 4 richer, 4 poorer; total sixteen.

Why are good intentions like fainting ladies? Because all they want is carrying out.

What is the difference between a carriage-wheel and a carriage-horse? One goes better when it is tired; the other don't.

Formed long ago, yet made to-day,
I'm most employed while others sleep;

What none would like to give away,
Yet no one likes to keep?

Bed.

I came to a field and couldn't get through it,

So I went to a school and learned how to do it?

Fence.

What is that which, supposing its greatest breadth to be four inches, length nine inches, and depth three inches, contains a solid foot? A shoe.

What was the difference between Noah's ark and Joan of Arc? One was made of wood, the other was Maid of Orleans.

There is a word of three syllables, from which if you take away five letters a male will remain; if you take away four, a female will be conspicuous; if you take away three, a great man will appear; and the whole word shows you what Joan of Arc was? He, her, hero, heroine.

What is that which a young girl looks for, but does not wish to find? A hole in her stocking.

ANCIENT ORDER — OF THE — IRON CROSS

BY
SAM LOYD



THE DISCUSSIONS pertaining to the armless statue of Titus Livius, in the famous Corsini collection, are very similar to those of the Venus de Milo. In both cases the statues were discovered without arms, and either for lack of artistic ability or owing to certain anatomical difficulties or contradictions, sculptors have been unable to suggest acceptable restorations.

In the case, however, of Titus Livius, the warrior and historian, who was the founder of the order of the Iron Cross, a curious legend has been unearthed which carries with it the paradoxical implication that the lack of arms was a necessary feature to the completeness of the statue.

It is stated that Caesar Augustus, the first Roman Emperor, while riding one day in his chariot, espied the soldier Titus Livius, who had lost an arm in battle, begging alms of passers-by. Augustus addressed the veteran and asked why he had not received the cross of honor and pen-

sion awarded to such as had lost a limb in honorable service.

"Great Caesar!" replied the warrior, with becoming modesty, "I was but an humble soldier in the ranks, and was doubtless overlooked." Caesar took the decoration from his own breast and placing it upon the soldier, said: "If thou hadst lost both arms, thou shouldst be the founder of a new order." Whereupon the soldier promptly drew his sword, and by a deft stroke lopped off his other arm!

We will not go into a discussion of the paradoxical features of the exploit, by asking with what arm he must have drawn the sword to chop off "the other," as it is a matter of history, that Titus originated the well-known Victoria Cross which is closely allied to that of the St. Andrew's form.

In designing the insignia for a new order of the Iron Cross, Titus had to conform to the established law of adopting a symmetrical form of cross which could be constructed from the parts of a square.

By reversing this proposition

we obtain a remarkable puzzle which forms an important link in the mysterious chain of relationship which connects all of the ancient signs and symbols, including the square, triangle, cross, swastica, monad, crescent, etc., etc.

The puzzle is merely to divide a square piece of paper into the fewest number of pieces which will fit together so as to form the irregular St. Andrew's Cross, as shown in the sketch.

False Logic.

A brute of a judge recently refused to allow damages to be awarded for killing an infant. His line of reasoning must have been somewhat as follows:

A baby is a crier,

A crier is a messenger,

A messenger is one sent,

One cent is not worth two cents;

Therefore, a baby is not worth two cents.

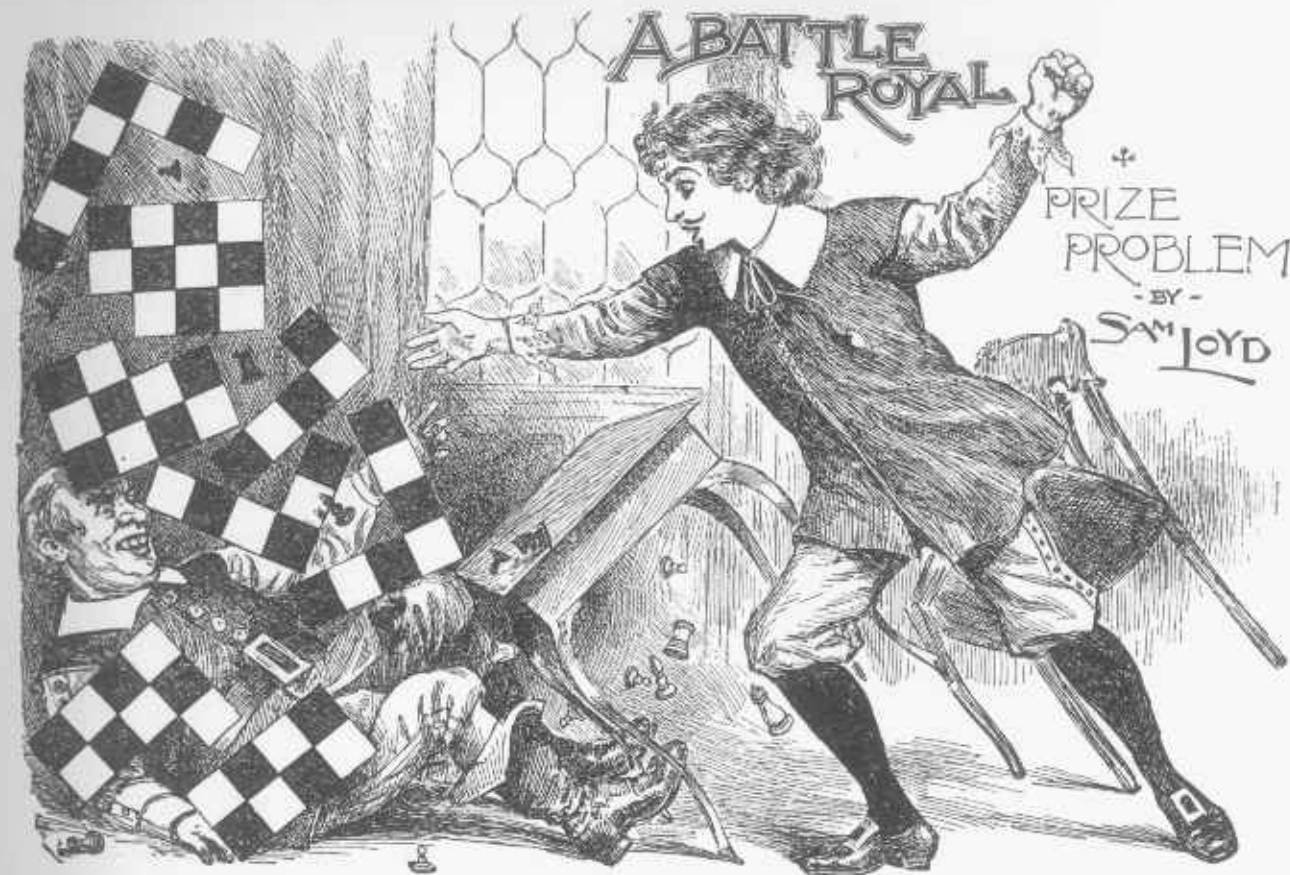

PROPOSITION.—Rearrange the eight pieces so as to form a perfect checker board.



IN THE HISTORY OF the kings of France is told an amusing story of how the Dauphin saved himself from an impending checkmate while playing at chess with the Duke of Burgundy by smashing the chess board into eight pieces over the Duke's head. It is a well-known story often quoted by chess writers to prove that it is not always politic to play to win, and has given rise to a strong line of attack in the game known as the King's gambit.

Now, my view of it is that the Dauphin was an enterprising sort of a fellow, who had gotten up the match upon the most approved modern methods of playing for the biggest purse that any club would hang up, inclusive of the kinetoscope rights of the play, so when at the end of an hour his opponent had winked but once, and it required some 30,000 pictures to show that he had transferred his piece of chewing gum from the right to the left cheek, the young Dauphin's backers called on him to throw some action into the pictures, with the result that he turned the tables on his ad-

versary in a way that has made the incident one of the most notable events in the annals of the royal game.

The smashing of the chess board into eight pieces was the feature which always struck my youthful fancy, as it might possibly contain the elements of an important problem which had been overlooked by historians, the more especially as I could find no authentic reference to the putting together again of the broken chess board. The restriction to eight pieces does not give scope for great difficulty or variety, but not feeling at liberty to depart from historical accuracy, I shall give our puzzlists a simple little problem suitable for summer weather: Show how to put the eight pieces together so as to form a perfect 8x8 checker board. The puzzle is a simple one, given to teach a valuable rule which should be followed in the construction of tricks of this kind, viz.: By giving no two pieces of the same shape, other ways of doing the puzzle are prevented, and the feat is much more difficult of accomplishment, as you will find before discovering the answer to this one.

Draw an 8x8 checker board on paper and try to find how to cut it into eight pieces like those shown.

When is a soldier like a watch? When he is on guard.

What word of ten letters can be spelled with five? X-p-d-n-c (expediency).

Why should the highest apple on a tree be the best one? Because it is a tip-top apple.

Why would a spider appear to have wings? Because it often takes a fly.

Why is a railroad exceedingly patriotic? It is bound to the country with the strongest ties.

What is the most wonderful feat in jugglery? For a man to revolve a thing in his own mind.

Why is chloroform like Mendelssohn? Because it is the greatest of modern composers.

Do women like to see themselves in print? No; they prefer silk or satin.

Who is the man who invariably finds things dull? The scissors grinder.

What sort of men are most above board in their actions? Chessmen.

THE GUIDO MOSAICS PUZZLE BY SAM LOYD

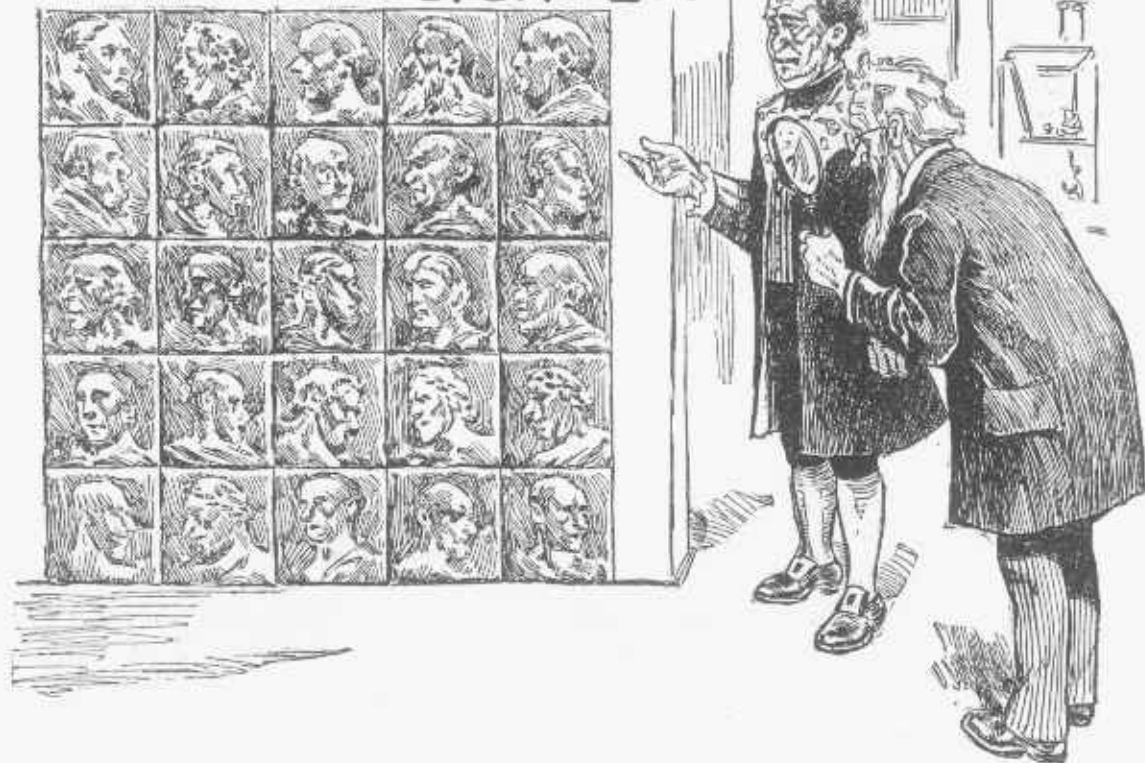

PROPOSITION—Show how to divide the mosaics into two squares.

IT IS NOT GENERAL-ly known that the celebrated piece of Venetian mosaic by Domechio, known as the Guido collection of Roman heads, was originally divide into two square groups, which were discovered at different periods. They were brought together and restored into what is supposed to be their correct form, in 1671. Considerable discussion was aroused regarding the possibility as well as appropriateness of uniting the collections of 25 heads into one square, as it now exists, when, apparently by accident, it was discovered that each of the two squares consisted of several pieces which would fit together into one 5x5 piece as shown.

It is a pretty puzzle, and as all puzzles, like mathematical propositions, can be worked backwards to advantage at times, we will reverse the problem, and ask you to divide the large square into the fewest number of pieces which can be refitted into two squares which conform to the conditions described.

This puzzle is given as differing

from the Pythagorean principle of cutting lines on the bias, for, while we know that by the theory of the hypotenuse line two squares can be divided so as to produce one larger square, and vice versa, it is assumed in this puzzle that we must cut on the lines only, so as not to destroy the heads. It may also be mentioned incidentally, that students who have mastered the principles of square root, as explained in the Pythagorean problem, will not find much difficulty in discovering the same old theory cropping up among the Roman antiques, to tell them how many heads there must have been in the smaller squares which saves considerable experimental work.

As a lesson in puzzle construction it may be said that problems of this kind which call for the "best" answers, in the "fewest number of pieces," etc., offer great scope for cleverness. Anyone might find a solution in many pieces, or which stands some of the old Romans upside down.

Why is the emblem of the United

States more enduring than that of France, England, Ireland, or Scotland?

The Lily may fade and its leaves decay,

The Rose from its stem may sever,

The Shamrock and Thistle may pass away,

But the Stars will shine forever.

Why is a kiss like a sermon? Because it needs two heads and an application.

When two people kiss, what kind of a riddle does it make? A rebus.

What is it George Washington seldom saw, God never saw, and we see every day? Our equals.

Prove by logic that an oyster is better than heaven. Nothing is better than heaven; an oyster is better than nothing; therefore an oyster is better than heaven.

What is the difference between a honeymoon and a honeycomb? One is a big sell, the other little cells.

Why is a man who makes pens a wicked man? Because he makes men steel (steal) pens and then says they do write (right).

PROBLEMS OF HISTORY BY SAM LOYD.



IN ACCORDANCE with the time honored belief that mathematics and history are the most important branches of education, in my early days I was presented with nine ponderous volumes of Hume's History of England, accompanied by promises galore of guns, ponies, and everything else calculated to excite a boy's energy if I would only study those books.

Our puzzlists would not be interested in putting me through an examination of ancient history, as they would find that what I don't know on that subject would more than double the size of an ordinary library, but some of the things which I did discover about those ponderous tomes may be worth mentioning as the subject of an interesting and instructive puzzle.

In experimenting for instance, it was found that by placing the four volumes above the eight, as shown in the picture, 6729 over 13458 is equal to one-half. Then

by another mix-up of the books, always employing them all, they may be made to represent the equivalents of one-third, one-fourth, one fifth, one sixth, one-seventh, one-eighth, and one-ninth. It is a simple puzzle, without any mathematical difficulties, so it is presented as an amusing study which will familiarize the young folks with the peculiar properties of figures.

This problem suggests an inexhaustible field of puzzles and an excellent school for learning to originate new puzzles, as the idea can be carried on indefinitely in the construction of other and more difficult problems.

What are the embers of the expiring year? Nov-ember and Dec-ember.

How is a poultry dealer compelled to earn his living? By foul means.

Why is a butcher's cart like his top boots? Because he carries his calves there.

Why does a maltese cat rest bet-

ter in summer than in winter? Because summer brings the caterpillar (cat-a-pillow).

Is there anything a man with a kodak cannot take? Yes, a hint.

Why do American soldiers never run away? They belong to a standing army.

Why does tying a slow horse to a post improve his pace? It makes him fast.

What is it that a man, no matter how smart he is, overlooks? His own nose.

What goes most against a farmer's grain? His reaper.

Why may we suppose that Noah had beer in the ark? Because the kangaroo went in with hops, and the bear was always bruin.

A duck before two ducks, a duck behind two ducks, and a duck between two ducks; how many ducks were there in all? Three in line.

How many fathers has a man? Nine: his father, his godfather, his father-in-law, his two grandfathers, and his fore- (four) fathers.



PROPOSITION—Divide seven quarts and seven pints of wine, and five empty quarts and five empty pints.

THERE IS A LITTLE study in subtraction and division which shows the importance of being well up in elementary arithmetic, no matter what our vocation in life may be. Solvers with an aversion to figures, however, need not be deterred from tackling the puzzle, for the subtraction and division here referred to calls for the cleverness of a Sherlock Holmes rather than the learning of a mathematician.

It appears that a gentleman's wine cellar had been burglarized to the extent of two dozen bottles of wine, which the robbers carried off and might have kept if they had been as proficient in division as they were in subtraction.

They stole a dozen quarts and a dozen pints of champagne, but finding the same somewhat heavy to carry, they proceeded to reduce the weight by drinking off five quarts and five pints to the success of their respective candidates in the next aldermanic election. To leave no traces behind, as well as on account of their value, they took the empty bottles with them, but upon reaching their rendezvous they could not hit upon an equitable division of

seven full quarts and five empty ones, and seven full pints and five empty pints, so that each should have the same value in bottles and wine, although the same would have been an easy matter, probably, if they had not already imbibed so freely as to muddle their brains.

Not knowing enough to keep "mum," which was very essential in this case, they quarreled and made a great racket, which attracted the attention of a couple of policemen, who descended upon them and drank all of the champagne which had cost them so much labor to secure. But that, as well as what became of the empty bottles, like the question as to how their heads felt in the morning, has nothing to do with this puzzle.

Without asking me for any further information, as I do not wish to appear to know too much about this transaction, I require you to tell me how many burglars there were and how they might have divided their seven quarts of wine and seven pints of wine, and the five empty quart bottles and the five pint bottles so that each man would have an equitable share. Of course it is assumed that no wine is to be transferred from one bottle to another.

Any reputable burglar knows that champagne can not be handled in that manner, so there is no opportunity of introducing a clever juggling trick in connection with the puzzle.

Poetical Decapitations.

Here is an odd little bit of decapitation, where the removal of the first letter, then the second, third and fourth in the three missing words, makes the meaning clear:

The lilies on the bank are —, —,
While in our little bark we're — —,
Our course to favoring breezes — —,
Like birds upon the — —.

With lily-pads the oars are — —,
As eager hands the blossoms — —;
Each shouts "Dull care away — —,"
And echo answers " — —."

It seems to me a strange — —,
That we should pay so great — —,
For trifles like a little — —,
Or such a common thing as — —.

19 35 2



Pythagoras' CLASSICAL BY- PROBLEM SAM LOYD

PROPOSITION—Take a piece of paper of the dimensions of the two squares, as shown in the picture, and cut it into three pieces which will fit together and make a perfect square.

IN ACKNOWLEDGMENT of a flattering criticism from Professor Rogers, which is going the rounds of the press, wherein he says, "Sam Loyd is doing more to encourage higher mathematics than all of our colleges put together," accompanied by a hearty endorsement from a noted professor, I take occasion to discourse upon what he terms my life-long hobby."

Half a century's interest in puzzle matters has shown me that in puzzles we have the only elementary school for the development of ingenuity and a love of the mathematical and mechanical arts. I have witnessed such a wonderful record of civil service examinations, as well as growth of master minds from the ranks of puzzledom, that, when I hear of a puzzlist trying for some competitive position, it seems like a foregone conclusion that his success is assured. On the other hand, my connection with mechanical matters frequently shows a class of graduates whose course of study appears to have made them so stupid as to be unfitted for their professions.

The "kindergarten school" of teaching aims to fascinate pupils with their studies, and is built upon the fundamental law that the mind should not be burdened with rules which are to be committed to memory. If the theory of the lesson is made clear, the student formulates his own rules and methods, just as one describes an incident in his own language.

The science of mathematics is heavily freighted with musty rules, so ponderous and obscure that few even with explanations, grasp their meaning, and are glad to dismiss them from their minds when they leave school or college. When a principle is thoroughly understood difficulty ceases to exist, for even in what are termed abstruse calculations we can do nothing but add or multiply, so, while it may take more time to multiply 888,888 by 777,777 it is really as easy as to multiply 8 by 7. The difficulty of a complex sum is due entirely to lack of knowledge, or familiarity with the principle involved.

Mechanical science and the principles of higher mathematics may be taught through the medium of a simple puzzle, and to relieve the dry

technicalities a little fun may be injected into the puzzle story which will do much toward cultivating an appreciation of humor. The problem should be clothed in suitable dress to make the result sought appear probable and more readily understood. It is well also to base the proposition upon some mechanical truth, historical incident or bit of classical lore such as may improve the general knowledge of the student, for in this way a thousand and one little tid-bits of information may be picked up and unconsciously stored away in the mind in a way never to be forgotten.

Twenty-four hundred years ago Pythagoras discovered that if he drew squares upon the three sides of a right-angled triangle the larger square will be exactly equal in area to the two smaller squares combined.

He was so elated over the proof of the larger square being equal to the other two, no matter what might be the dimensions of the triangle that he gave away all of his worldly goods and chattels in offerings to the gods, and yet he was ridiculed and told to show his discovery to the dogs.

Focas'le Yarns



PROPOSITION—Can you solve Neptune's conundrums?

SPEAKING ABOUT stock jokes and the nerve not to say phenomenal genius, required to get them off repeatedly in a way that preserves a resemblance of freshness and impromptu originality, I suppose that comparatively few of our readers have had the luck or occasion to cross the equator, so as to witness the jolly pranks which the jack tars are prone to indulge in when "crossing the line."

The first time I witnessed it I expressed to the captain my un-

bounded appreciation and admiration of the humor and ready wit of the old salt who represented King Neptune, as well as the lubbering lout whose main duty was to be knocked about and soused with buckets of water. I laughed at Neptune's ready reply to the droll conundrum: "What would you do if all the seas were dried up?" And the equally good one: "Why is a man as is lookin' for the philosopher stone like Neptune?" and the more up-to-date one, "why are wash-women great navigators?"

The captain looked a little quizzical as I complimented the men so lavishly, but I did not realize how green I must have appeared until, many years afterward, I crossed the line on several occasions and heard the same old stock jokes rehearsed, with all the former vigor and freshness!

As I said before, some of our younger folks have not yet crossed the line, so they are given this opportunity to ponder over the two conundrums as propounded by Father Neptune.

THE MAN WITH THE HOE

BY SAM LOYD.



PROPOSITION—Tell how two hayseeds divided their earnings.

AS SHOWING HOW intuition, or a practical knowledge of farming, will sometimes solve a puzzle which might baffle those who revel in figures and calculations, I ask for an answer to the following simple proposition, which is really so devoid of all semblance of mathematical difficulty that I hate to introduce it as a puzzle and yet, without offense to Edward Markham, the recognized authority in hosiery matters, I believe that, like his celebrated poem, it opens the doors for an interesting discussion, as

"Bowed by the weight of centuries he leans upon his hoe and gazes on the ground."

It appears that Hobbs and Nobbs agreed to plant a field of potatoes for Farmer Snobbs for five dollars. On testing their respective abilities they find that each one excels in a different branch of their profession. Hobbs, who can drop a row of potatoes in twenty minutes, can drop two rows while Nobbs covers two.

The puzzle is to tell how the money and work should be divided so as to equalize matters.

Mr. Hayseed says his "college-bred boy doesn't know nothing, while the other one does." The question is to tell which knows the most.

What keys will open the doors of civilization? The Yan-kees.

Why is a coach going down a steep hill like St. George? Because it's always drawn with the drag-on.

Which of the reptiles is a mathematician? The Adder.

Why is a thing purchased like a shoe? Because it's sold.

Why is a man who will only wager a penny likely to get well? He is a little better.

What relation does the soap-bubble bear to the boy who blows it? It is his air.

When is a sewing machine a great comfort? When it's used to sew lace.

What two female names express a chemist? Ann Eliza.

How would a leopard change his spots? By moving to some other spot.

Why are young ladies like arrows? Because they are all in a quiver until they get a bow.

Spell eye-water with four letters. Tear.

How would you divide seven eggs among seven persons so that one egg remains in the dish? One takes the dish with the egg in it.

What is often brought to the table, always cut but never eaten? A pack of cards.

When is a thump like a hat? When it is felt.

What is the best word of command to give a lady crossing a puddle? Dress up in front, close (clothes) up behind.

Why do hens only lay in the daytime? Because at night they are roosters.

What fort has been stormed the oftenest? The Piano-forte.

Take two letters from money and there will be but one left, but if a thief takes money from two letters there would be none left.

Why is a loafer like a weather-cock? Because he is continually going round doing nothing.

When does a man rob his wife? When he hooks her dress.

Why are dairy maids happy? They have their own whey.

Why is matrimony like a besieged city? Because they who are in want to get out, and those who are out want to get in.

THE BOXER'S PUZZLE

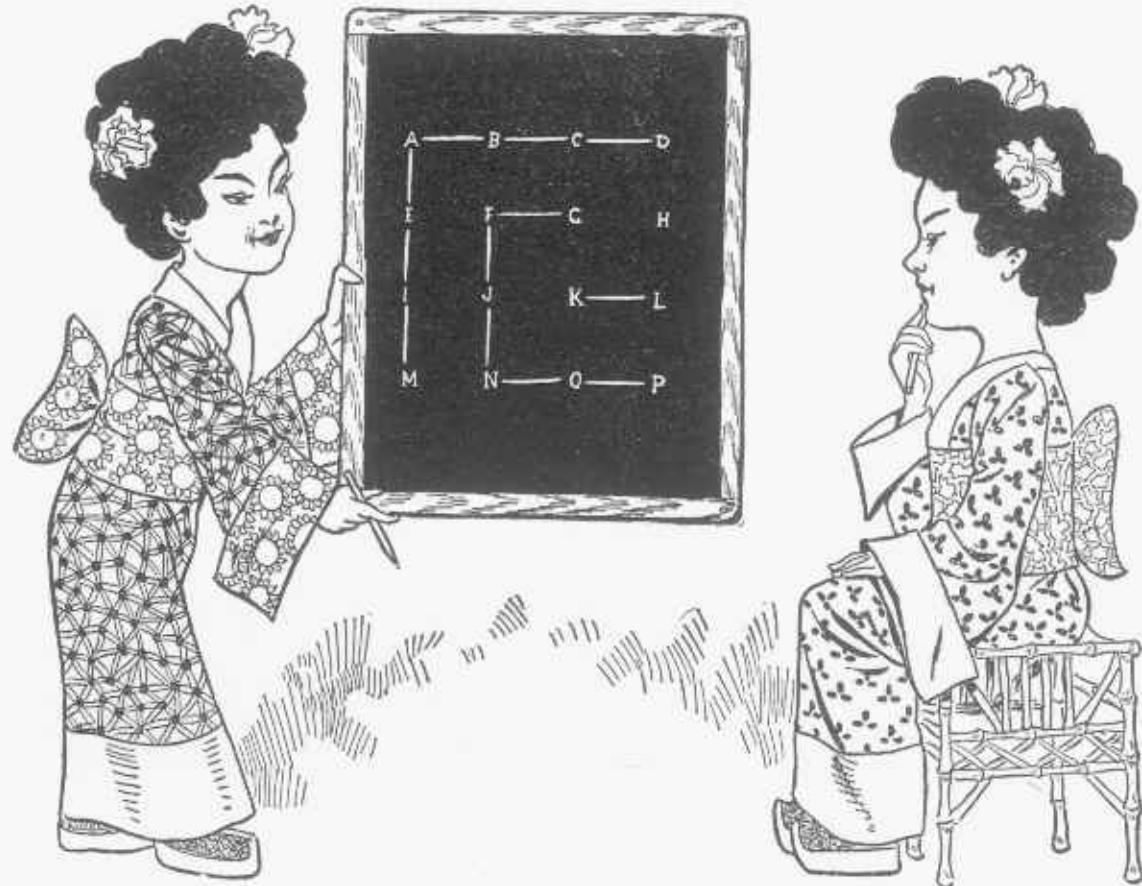

PROPOSITION—Show the best play and tell just how many "boxes" it should win.



HERE IS AN ODD little puzzle-game from the East which is played upon lines very similar to the well-known game of "Tit, Tat Toe, three in a row." One of the Chinese girls writes sixteen letters on a slate in four rows, as shown, and after marking a straight dash, which connects A to B, passes the slate to her opponent, who connects E with A. If the first player should now connect E with F the other player would connect B with F and score "one box," and have the right to play again. But they have played so well that neither one has yet scored a box, although each has played six times, but the game is reaching a critical point where one of them must win, for there are no draws in this play, as in other games. The little maiden sitting down has to play now, and if she connects M and N her opponent could score four boxes in one run, and then having the right to one more play would connect H and L,

which would win all the rest. What play would you now advise, and how many boxes will it win against the best possible play of the second player?

Remember, that when a player scores a "box," he plays again. Suppose for example a player marks from D to H, as the game shows on the slate. Then the second player marks from H to L, and then no matter what mark the first player makes, the second player scores all nine boxes without stopping. It is a game that calls for considerable skill as you will discover after trying a few games. But in the game shown on the slate, where each player has made six marks, you are asked to tell what is the best play now to be made and how many boxes will it surely win?

What's the difference between a bee and a donkey? One gets all the honey, the other gets all the whacks.

Why is the letter N like a pig? Because it makes a sty nasty.

What must you add to nine to make it six? S, for IX with S is six.

Twice ten are six of us,
Six are but three of us,
Nine are but four of us,
What can we possibly be?
Would you know more of us?
I'll tell you more of us:
Twelve are but six of us,
Five are but four, do you see?

If you asked the Alphabet to come to dinner, which letters could not accept your kind invitation till later in the evening? The last six, as they couldn't come till after T.

What kind of a cravat would a hog be most likely to choose? A pigs-tye, of course.

A man bought two fishes, but on taking them home found he had three; how was this? He had two—and one smelt.

Why is a room full of married people like an empty room? Because there is not a single person in it.

Which one of the United States is the largest and most popular? The state of matrimony.

PICKET POSTS

A PUZZLE
BY
SAM LOYD

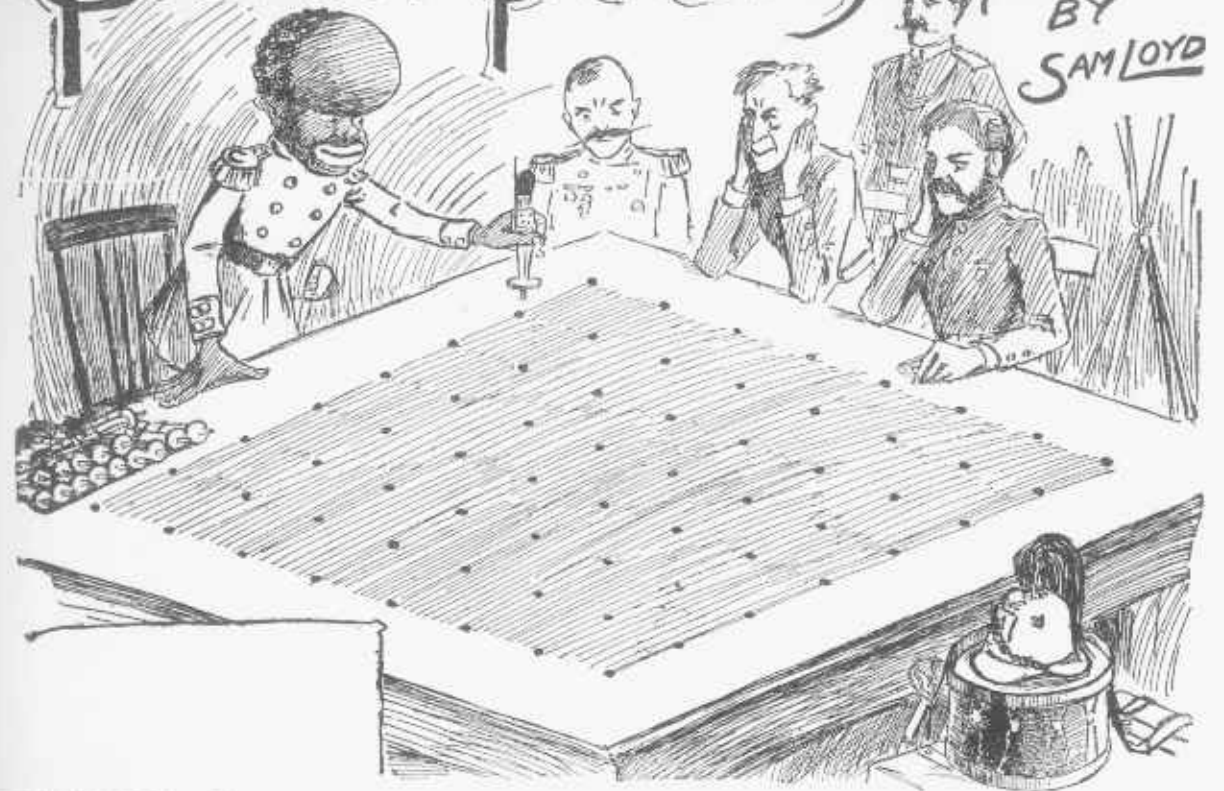

PROPOSITION—Place two officers in the center of the field, guarded by fourteen men, so that there are no three in line.



HERE IS AN ODD little problem in military tactics which can be worked out advantageously upon an ordinary checker-board of sixty-four squares, the puzzle being to place sixteen checkers upon the board so that there shall not be more than two in a line in any possible direction. In the puzzle given, however, it is stipulated that we begin by placing two officers upon the spots as near as possible to the center of the field. This makes the puzzle less difficult, as we have two of the men placed properly to begin with, and the problem is then merely to post the other men so that there shall be no three in a line. In other words, after the sixteen figures are posted correctly a cannon ball coming from any possible direction could not hit more than two men. It is a pretty and interesting puzzle, somewhat akin to the famous problem of placing eight queens upon a chessboard so that none can be taken by another. It yields readily to a system of exhaustive analysis which may be introduced upon a simple

plan, but will try the patience of such as attempt to master it by hap hazard experimental methods. The theory of analysis by exhaustive trial, enters largely into puzzle practice in the construction as well as guessing of problems and pertains to an invaluable training of the mind. First place the officers in the center of the board, and then devise a method of exhaustive analysis which will ring every possible change of the placing of the fourteen men so that the same trial positions never recur a second time.

Why does a minister always say "dearly beloved brethren" and not refer to the sisters? Because the brethren embrace the sisters.

In what liquid does the Queen of England take her medicine? In cider (side her).

Why is a restless man in bed like a lawyer? Because he lies on one side, then turns around and lies on the other.

Why do tailors make very ardent lovers? Because they press their suits.

What is the difference between a rejected and an accepted lover?

One misses the kisses and the other kisses the misses.

Why is a lover like a knocker? Because he is bound to adore (a door).

In what colored ink should we write our secrets? In violet (in-violate).

Why is a young lady like an arrow? Because she can't go off without a bow (beau), and is in a quiver till she gets one.

If a young lady fell into a well why couldn't her brother help her out? Because, how could he be a brother and assist her (a sister) too?

Why does a Russian soldier wear brass buttons on his coat, and an Austrian soldier wear steel ones? To keep his coat bottomed.

What is the difference between an old penny and a new dime? Nine cents.

How is the best way to make a coat last? To make the trousers and vest first.

What word of four syllables would a man utter if he should eat his wife and wanted to express his approbation of the deed? Gladiator (glad I ate her).

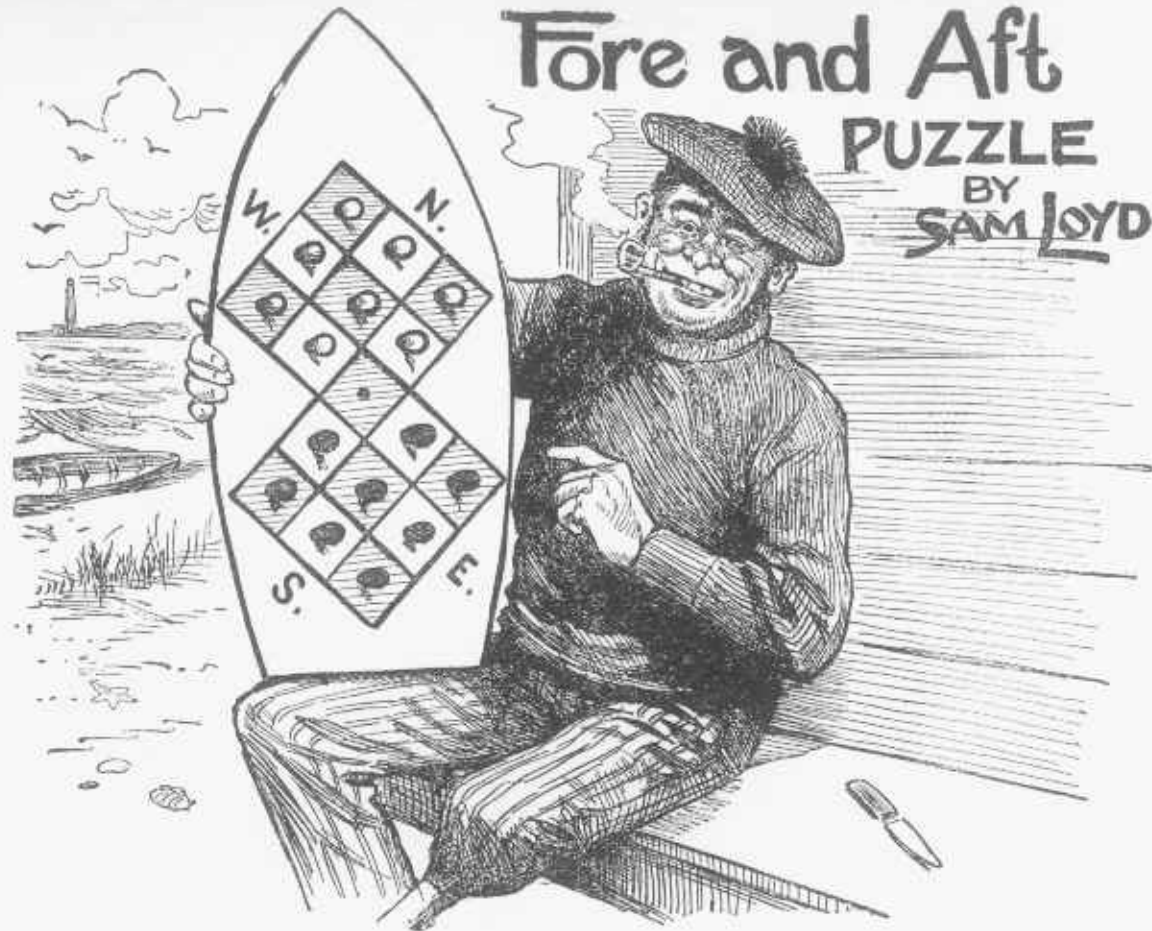

Fore and Aft PUZZLE BY SAM LOYD

PROPOSITION—In how few plays can you move or jump the pegs from the north to the south and the others from the south to the north?

TAKE OCCASION to call attention to the origin of a pretty puzzle game, or species of solitaire, which became quite popular in Europe. It is an English invention, in that it was originated by an English sailor, who spent forty years of his life at Sailor's Snug Harbor, on Staten Island, and whose proud boast was that he had sailed under Captain Randall, the founder of the institution.

The old sailor used to pick up quite a little bit of extra "baccy silver," as he termed it, by selling the puzzles to visitors as fast as he could whittle them out with a jack-knife. The game was brought out in London and enjoyed quite a run under the name of the English sixteen puzzle, but was never marketed on this side of the pond.

The object of the puzzle is to move the set of pegs from the right to the left and those on the left over to the right, like in the old 14-15 puzzle, from one square to another, with the additional privilege of

jumping over a peg to a vacant hole, to expedite matters. The problem is to transpose the positions of the black and white pegs in the fewest number of moves, and the board is marked North, South, East and West, to enable puzzlists to record the sequence of their plays.

According to an eye witness, the old sailor was very proud of his expertness, and used to give purchasers a rule to perform the feat in the fewest number of plays. He was mistaken, however, in his rule, or it must be classed along with the lost arts, or perhaps the world has advanced since his time, for the methods given in the English puzzle books, as well as mathematical works, to be the shortest, are defective and may be shortened by several moves.

Remember that the pieces move squareways, so as to change to an opposite color each time, and not like playing checkers.

Who was the most successful financier mentioned in the Bible?

Noah, because he floated a limited company when all the rest of the world was in liquidation.

Why is a schoolmaster like the letter C? He forms lasses into classes.

Why are authors who treat of physiognomy like soldiers? Because they write about face.

I went into the woods and caught it, I sat down to look for it, and then I went home with it because I could not find it. A splinter.

How did the whale that swallowed Jonah obey the divine law? Jonah was a stranger and he took him in.

Why is the polka like bitter beer? There are so many hops in it.

Why is your nose in the middle of your face? Because it is the scenter.

When may two people be said to be half witted? When they have an understanding between them.

Why is a jailer like a musician? Because he fingers the keys.

Why is a field of grass like a person older than yourself? Because it's past-your-age (pasturage).

Puzzle of THE DEWEY PILLOW. BY SAM LOYD.

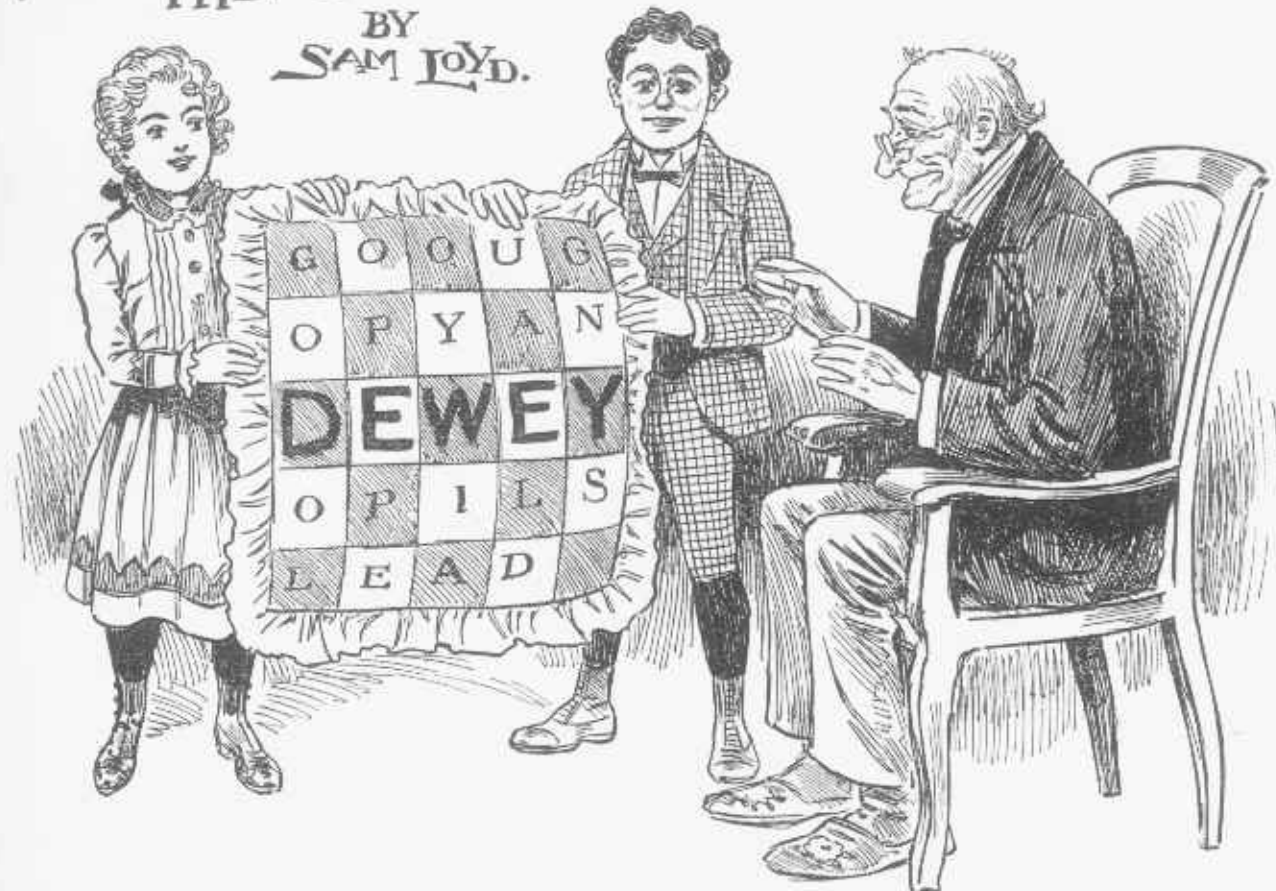

PROPOSITION—Commencing with the left hand upper corner, G, decipher a continuous sequence of twenty-four letters which reveal the intended motto.

SPEAKING ABOUT appropriate and timely presents, I wish to tell the young folks how Harry and his sister Nelly sprang a brilliant surprise upon their grandfather. It was his 93d birthday, and the children presented him with an elegant "sleepy pillow," as they termed it, for his sofa. He was an old navy officer, so they had to make him happy by introducing the name of Dewey in the middle of it, but in accordance with their own plan of working in a secret cryptogram which would conceal an appropriate motto, they raked their young brains to find a sentiment which would be suitable for the occasion.

Of course, mistakes are liable to happen in the best regulated families, especially when the moving spirits are so young, and it would be misleading if I should intimate that the motto was as appropriate as it might have been; nevertheless,

if our puzzlists exercise their brains over this problem as much as Harry and his sister did, they will deserve prizes if they succeed in unraveling it. Commence at the G on the upper left-hand corner, and move in any direction to adjacent squares, so as to spell out a continuous sequence of the twenty-four letters, which reveals the intended motto.

If from a reasonable quantity of my second, I frequently but judiciously take my first, it will materially contribute to my whole? Support.

When do we see cannibalism? When a rash man eats a rasher, or when the cook fries a little Indian meal for you.

Why does a poor tailor spoil your disposition? He gives you bad habits.

Why are tottering houses like false reports? They are stories without any foundations.

When is a skein of thread like the

root of an oak? When it is full of knots.

Who has a mouth but never speaks, and a bed but never sleeps in it? Mrs. Sippi.

Why are children like castles in the air? Their existence is only in fancy.

What is higher and handsomer when the head is off? A pillow.

Why is a proud girl like a music box? She is full of airs.

Why is a short negro almost white? Because he is not a tall black.

Why are discontented people easily satisfied? Because nothing satisfies them.

Why are ripe potatoes in the ground like thieves? They should be taken up.

Why is a man going to town like one prepared to parry a blow? He is going to ward it.

Why is swearing like an old patched coat? It's a darned bad habit.

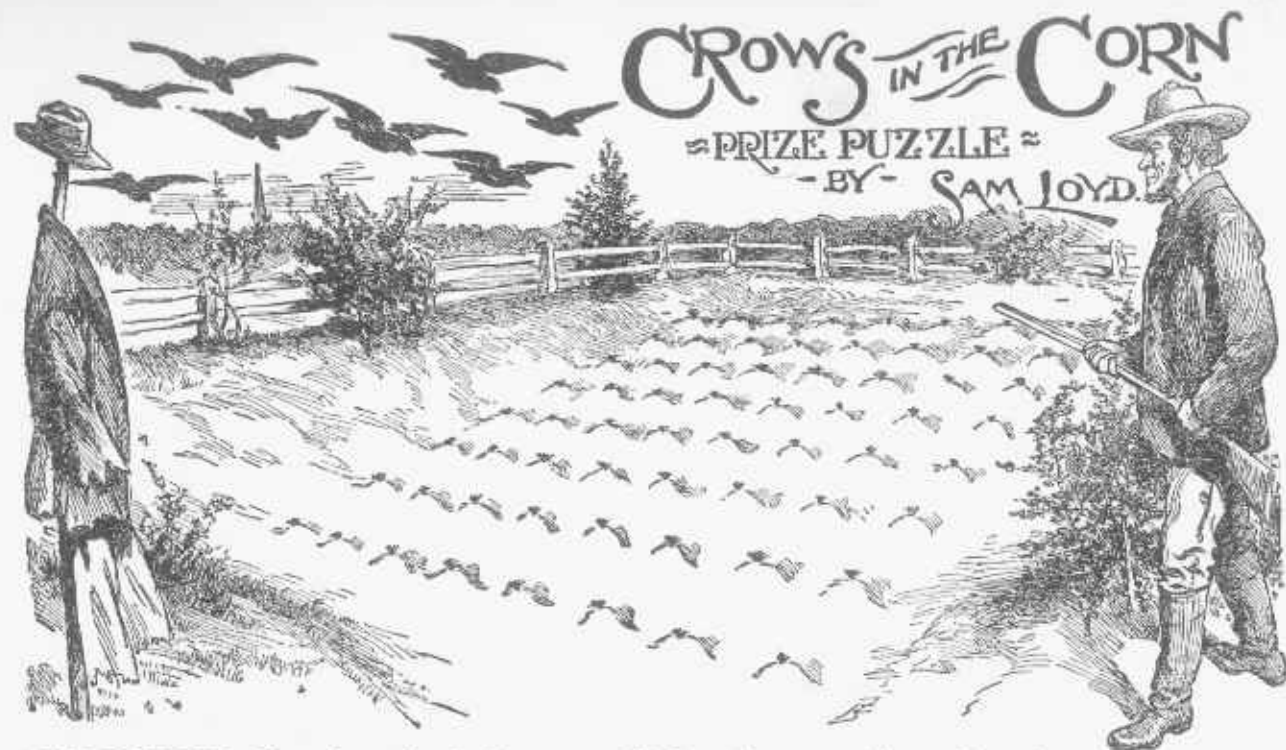

PROPOSITION—Show how the eight crows settled on the corn with no three in a row.



NOTED ORNITHOLOGIST, describing the habits and sagacity of birds, tells how he witnessed a flock of marauding crows descend upon a corn field and dispose of themselves according to established military tactics. Each bird was posted like an army picket, so as to keep an unobstructed view of every one of his companions, and by his motions apparently maintain a noiseless code of signals which kept the entire flock informed of any approaching danger.

Without attempting to investigate the mysteries of crow wireless telegraphy, occasion is taken to show that the statement of the distinguished ornithologist suggests a very pretty problem in the science of picket posting.

Take sixty-four points like the centers of the squares of an 8x8 checkerboard, as represented by the hills of sprouting corn in the picture, and the puzzle is to place eight crows on such points that there are no two crows on the same row or diagonal; and so that the man with the gun going around the field would find it impossible to get a shot at three birds in a row. The puzzle is closely allied to my well-known problem of placing eight queens on a chess board so that none is attacked by another, but is an improvement upon the same in that there is but one way of performing

the feat, while to the other there are twelve different answers, which by turning the board might be increased to 96 transpositions.

The Secret-of-Success Puzzle.

A country grocer, who was always complaining about his lack of success, fell asleep one day in his store, and dreamed that his goods were discussing the secret of success. "No one should do busi-

ness on tick," said the clock. "One wants push," said the button. "And never should be led," said the pencil. "Take pains," said the window. All of the articles in the store had something to say, and their remarks were so good that it becomes a puzzle worth propounding, to see if our friends cannot suggest a score or more bright things which the other articles might have said.



We have just had one war;
Keep us from having another.



PEAKING ABOUT labor strikes which are occupying the public attention at presents reminds me of a war problem I thought to sketch for our juveniles the other day while passing through one of our manufacturing centers. There was a certain parade and mobilization of troops going on, which so revived my old-time patriotism and military spirit that I joined the crowd and cheered for the Union, when, to my dismay, I discovered that I was participating in a labor strike and shouting for the motor-men's union, whose members were bent upon pulling up the car tracks.

Despite my sympathy for the laboring men, I found that my enthusiasm had placed me in a false position, so I most heartily indorsed the sentiment of a good citizen as given in the description of the picture, which it will be found conceals the locality of the incident.

A PROBLEM.

As I was beating on the meadow grounds,
Up starts a hare before my two grey hounds;
The dogs, being light of foot, did fairly run,
To her fifteen rods, just twenty-one;
And the distance that she started up before,
Was six and ninety just and no more;
Now I would have you clever folks declare
How far they ran before they caught the hare?

Why may a beggar wear a very short coat? Because it will be long before he aets another.

NOTED.

Our juvenile puzzlists are so clever in getting at the correct locality of these concealed places, that I will ask them to explain a matter which puzzled me considerably some time ago.

I had heard a certain person referred to once as "the most noted man in his State," and, as his fame for any particular art or science had never reached me, I asked regarding his specialty, and was told that he was not looked upon as a great genius, but simply as being "noted." I was baffled by the puzzle, until it so happened that during a visit to his town I observed that strangers and friends alike were so struck by his remarkable appearance as to make him indeed the most noted man in town.



"Did you ever see such a color?"
"A downright brick red isn't it!"

I pass the puzzle on to our young friends, and will ask them to discover the locality of this noted man as concealed in the remarks which I heard upon the streets.

A REBUS.

A bird select, on moorlands bred,
And carefully remove its head,
Then your admirer, Ladies see!
Cut him, and past and gone he'll be.
Cypher Ans. 17, 13, 15, 22, 5, 18.

What is the difference between a mother with a large family and a barber? One shaves with his razors, and the other raises her shavers.

Why is a horse an anomaly in the hunting field? Because the better tempered he is the easier he takes a-fence (offense).

Which eat most grass, black sheep or white? White, because there are more of them.

When is a sailor not a sailor? When he's aboard.

Why are persons with short memories like officeholders? Because they are always for-getting every-thing.

What is that from which you may take away the whole, and yet have some left? The word whole-some.

What is a quick way to kill ants? Hit your uncle's wife on the head with a hammer!

What is the difference between dead soldiers and repaired garments? The former are dead men, and the latter are mended (dead)!

Why should painters never allow children to go into their studios? Because of them easles (the measles) which are there.

THE DOMINO PUZZLE

BY SAM LOYD

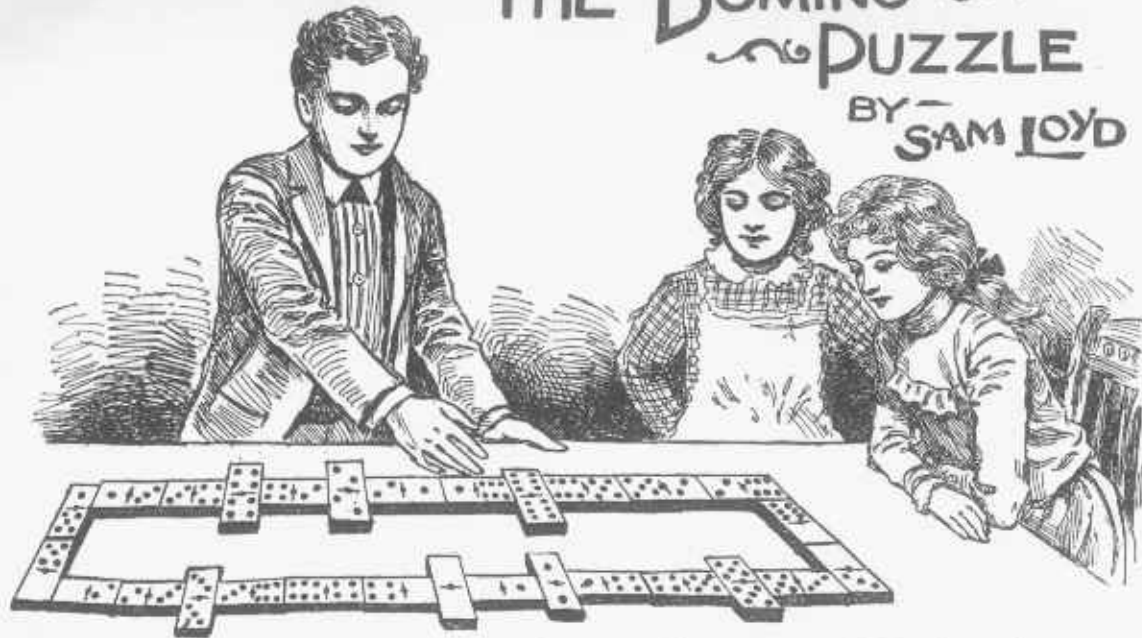

PROPOSITION—How many points can be scored in a game of dominoes?

I USED TO BE VERY fond of dominoes, and flattered myself that I could put up a pretty stiff game of straight muggins, but it was my privilege to meet a certain Monsieur Blume, in Paris, who speedily disillusioned me of the notion that I knew anything about the science of dominoes. He was a professional player, of about 80 years of age and had been blind from birth. He made a living by going about the cafes, giving exhibitions of his wonderful play in which he gave phenomenal odds to all opponents. I have upon several occasions alluded to the fact that every game or pastime is susceptible of furnishing a series of problems or puzzles, as in whist or chess, which illustrate in an instructive way the peculiar strategy of the play. M. Blume would always finish a game of dominoes after the manner of a problem, in that he would announce that he would make exactly five, ten or twenty points, as the case might be, and it was this feature of the play which suggested to me the domino puzzle of: "What is the greatest possible number of points that can be scored by both players in the regular game of muggins wherein the two ends are counted whenever they add up five, ten, fifteen or twenty?" It may be mentioned to such of our puzzlists who may not have a set of dominoes conveniently at hand, that the sketch shows a complete set of twenty-eight stones,

which may be utilized to solve the puzzle.

Just lay them down one at a time and count both ends whatever they add up, 5, 10, 15, or 20, and see how much you can make.

While on the subject of dominoes I will explain one of the neatest parlor tricks you ever saw. Take a full set of the 28 dominoes and mix them up well, and unobserved by any of the spectators conceal one of the stones in your hand. Tell them you will go out of the room while they match the set in one long row, and you will tell them what the two ends will be.

Be careful not to select a double number. Mix them all up carefully and while doing so return the one you had, at the same time telling them that the two ends were 3 and 1, or whatever numbers you had on the dominoe.

Here is another puzzle which incidentally introduces two very interesting subjects: the origin of the game of dominoes and that ever popular theme of the magic square.

According to a well-authenticated bit of history, two monks who had been committed to a lengthy seclusion contrived to beguile the dreary hours of their confinement without breaking the rules of silence which had been imposed upon them by building up magic squares with small flat stones, upon which they had black dots like "dice." The amusement gradually advanced into a species of a game of skill, and by a

preconcerted arrangement between the players the winner would inform the other of his victory by repeating in an undertone the first line of the vesper prayer. In process of time the two monks so far completed the set of stones as to represent every possible combination of two figures from double blank to double six and perfected the rules so as to make a most interesting game, so that at the end of the term of their incarceration it became generally adopted by all of the inmates of the monastery as a lawful and instructive pastime.

It soon spread from town to town and became popular throughout Italy, and the first of the line of the vespers was reduced to the single word Domino, by which the game has ever since been known.

An old writer on the subject says that the various combinations, or arrangements by which a number of the stones, being the same as our ordinary dominoes, might be formed so as to make magic squares which would add up the same in every direction, seems to have been lost, and its possibility has been questioned by eminent mathematicians. In this respect, however, the writer errs, for to modern puzzlists, who are familiar with the theory and construction of magic squares, the feat is an easy one, and as such I present it to our young puzzlists.

What is the keynote to good manners? B natural.

DISPUTED CLAIMS & PRIZE PUZZLE BY SAM LOYD

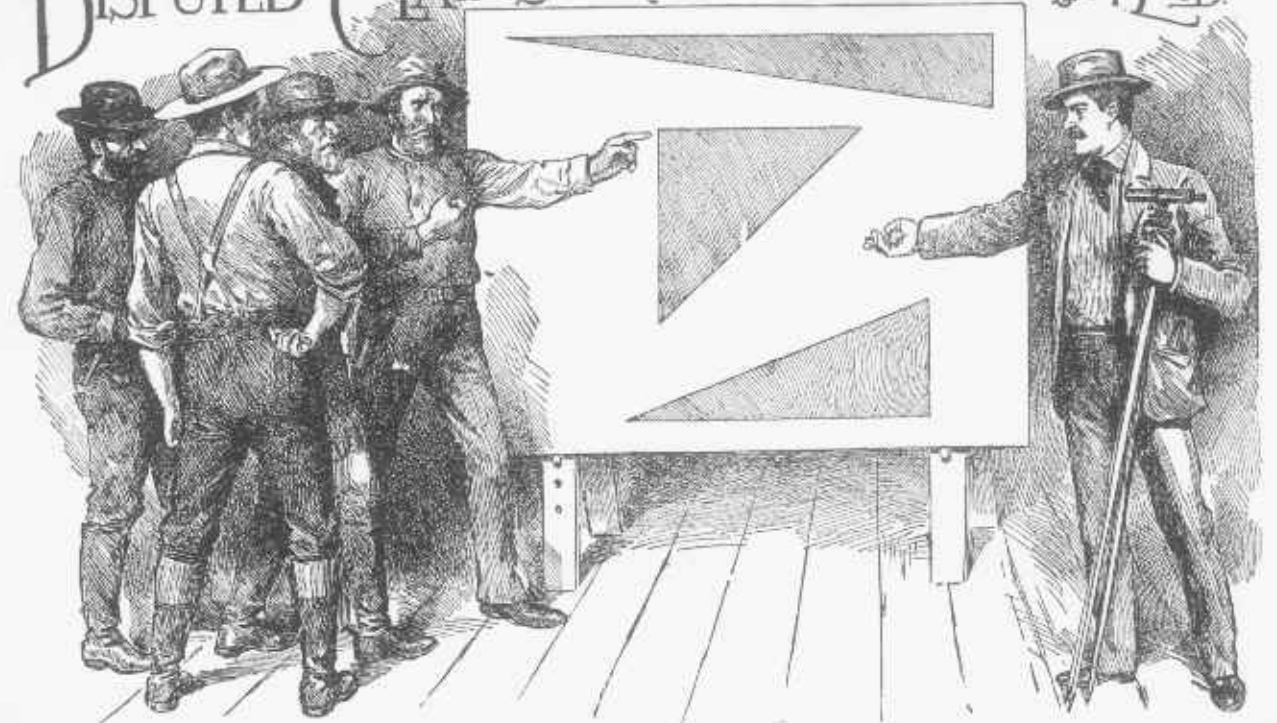

PROPOSITION—How many triangles can you make of the same size with different sides?

A PUZZLE EDITOR I take occasion to say that now and then a correspondent will write to ask why a certain solution obtained a prize, when, according to his way of thinking, his solution was "just as good." It may be a problem which turns upon a little mathematical point, and, whereas the winner followed the puzzler's custom of carrying the result out to only three decimals, the writer had gone to the pains of working it out to ten points, thereby producing what he considers a better answer. He employed half a dozen sheets of foolscap and worked out his solution by algebra. The winner's solution, produced by natural methods which anyone could understand, covered less than half a postal card, and clearly showed that he understood the point of the puzzle and could carry the answer out to any number of decimals, if the prize were offered for patience or endurance.

An umpire cannot always give his reasons for making an award, and so long as it is done fairly and impartially, should not open the way to discussions. It may be that the winner's answer came several days before the others, or was clear and sharp to the point, while the others

were vague and full of errors which the umpire does not desire to discuss.

These remarks are made as a hint for competitors to always give short, clear answers, as free as possible from mathematical terms. Solutions should be perfectly clear when they first go to the umpire, as no arguments or amended explanations should be accepted afterwards.

Our puzzle shows an animated dispute between some miners over their respective claims. It seems that they had obtained "patents" on some mining claims of the same size. Each claim was in the form of a right angled triangle, and all of exactly the same area, but of different dimensions, as would be the case with a triangle with a base of 35 feet, an elevation of 12 and the hypotenuse of 37, as compared with another with dimensions of 20, 87 and 29, as both contain areas of 210 feet.

The puzzle calls for a number of triangles containing 210 feet in each, with complete and definite dimensions without any two triangles being of the same shape. This puzzle gives great scope for ingenuity and perseverance, as it turns upon being able to discover the greatest number of such triangles.

How many right angled triangles of definite dimensions can you give,

which will all contain the same areas, but of different dimensions on the sides?

A REBUS.

Whether backwards or forwards
I'm read,
Matters to me not a bit;
I am gentle and light, and transposed
Am ever ready and fit.

CHARADE.

In battle-field when front to front,
Contending armies bear the brunt,
My first is in the fray;
If e'er with quantities perplexed,
You gents may measure with my
next,
Or with my total weigh.

Of what part of London does r
lame man remind us? Of cripple-
gate (cripple gate).

Why would a tanner make a good
chemist? Because he understands
ox (h)ides.

Why are you better looking than
a carpenter? Because he is a deal
plainer (planer).

Why is the letter F like death?
Because it makes all fall,

Whose chins are never shaved?
Ur-chins.

Why are gloves unsaleable arti-
cles? Because they are made to be
kept on the hand.

SAM LOYD'S PUZZLE

Sporty men are supposed to have unlimited nerve, and as a rule are seldom discouraged. Nevertheless, while returning from the Epsom races on the top of a "bus, I encountered the worst case of hopeless discouragement I ever witnessed. A little fakir who had been running a side show game known as the new Monte Carlo was bemoaning his fate to the shell-game man. Business had been "rather badly," as he put it, but in the hope of retrieving his fortune he stood out in a soaking rain for a couple of hours. He was preparing to give up in despair when a party of jolly fellows came along, and one of them, too far gone in liquor to know what he was doing, placed £10 on the 3, threw three of a kind, and cleaned him out of his last shilling!

The game is quite popular, and as no two persons can be found who give the same opinion regarding the chances of breaking this bank of Monte Carlo I offer it as an elementary problem in the theory of chances. There are six squares marked 1, 2, 3, 4, 5 and 6, as shown in the sketch, and all are invited to place what money they wish on one or more of the numbers. Three dice are then thrown, and all who pick the numbers which turn up get their money back and as much more. If you place \$1 on No. 5 and two 5s turn up you receive \$1 stake and \$2 more. If three 5s are turned you get \$1 and \$3. Now, then, how many of our clever mathematicians can tell what are the chances for or against the person who tries his luck?

What is that which you cannot hold ten minutes, although it is as light as a feather? Your breath.

What roof covers the most noisy tenant? The roof of the mouth.

Why does an orator resemble a pawnbroker? Because he lives by spouting.

What instrument of war does an angry lover resemble? A cross bow (beau).

Why is a horse smarter than a fox? Because a horse can run when he is in a trap and a fox can't.

Unsolved Riddles.

Probably every one of the millions upon millions of people who have enjoyed Lewis Carol's masterly and realistic description of the vagaries which flit through our minds while in dreamland have pondered over certain unanswered conundrums which were given by Alice in Wonderland.

While Alice, the Mad March Hare and the crazy Hatter were enjoying their tea, the hatter suggested some riddles, and asks, "Why is a writing desk like a raven?"

Alice said she believed she could guess it, but every time the question was revived it flitted from her mind, and faded away like that mysterious cat, which left nothing more tangible than its everlasting smile. It is safe to assume, however, that the famous Oxford mathematician and noted puzzlist had some clever answer up his sleeve, or he would not have propounded the conundrum.

The book itself is a riddle, and many persons, while revelling in its extravagant absurdities, have failed to recognize the faithful and wonderful description of a dream. It abounds in riddles and conundrums, like "Why was the turtle that kept

school like a tortoise?" Because he tort us. What is more puzzling than that tangle of words when the countess deduces the moral? Be what you would seem to be, or never imagine yourself not to be otherwise than what it appears to others that you were or might have been, would have appeared to them to be otherwise."

All of which is too apparent to require further digression from our subject:

Why is a writing desk like a raven?

I have never heard the answer, nevertheless, like the ancient query, "Why is a crow?" it has been asked so often that I am satisfied that our clever puzzlists will suggest a fitting answer.

CONCEALED GEOGRAPHY.

71. When in India Lord Raglan cast Eros, the blind dog, at his feet. Venus laughed.

71. The bride wore white, the bridesmaids blue. (An island.)

72. Trust no past, fear no future. (A river.)

73. Stocks, or rent, or what, make the best investment?

74. Did you ever read in Goldsmith of the curse of ambition?

75. The wounded are borne off the field on litters. (An island.)

76. Not money, but base love of money, harms.

77. a "A widowed bird sat, mourning for her mate, upon a wintry bough." (River.)

78. Tall or short, fat or lean, shall make no difference here.

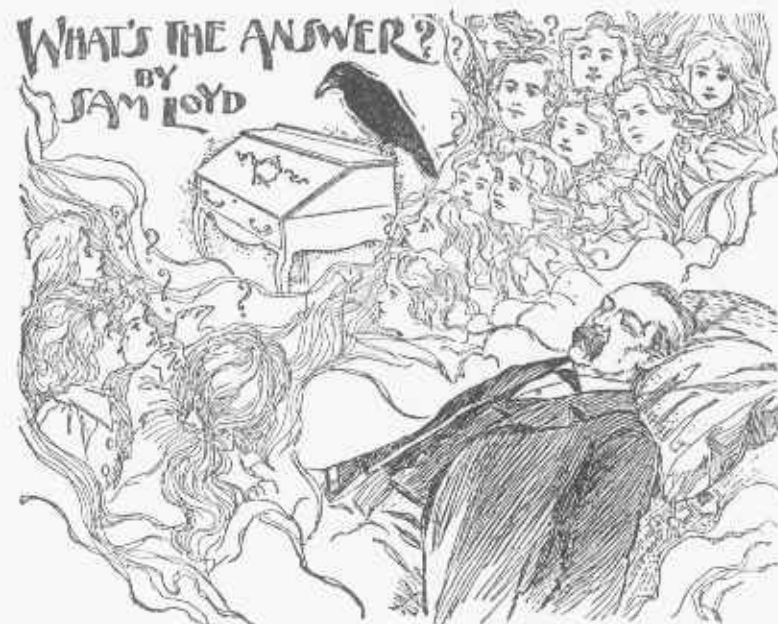

Occasion is taken to tell how a member of the recent expedition to the north pole attempted to capture a bride after the custom of the upper arctic circles. Every one sleeps in a bearskin sack up there, so when an elopment is planned the love-sick swain just creeps in and steals a sack with its valuable contents and bears it off to his home. In this case the lover had quite a distance to journey, but calculated that he could go there at the rate of 5 miles per hour and return with his burden at the rate of 3 miles per hour. He carried out the programme on schedule time, making the tour in just seven hours, but when he opened the sack to show the prize to his shipmates he found that he had run off with the girl's grandfather! The story has been so greatly exaggerated that it is claimed that he must have gone from Petermann's Point to Franz Josef's Land, and thence chased by the grandfather to several degrees beyond the parallel reached by Dr. Nansen in 1895. Will our experts assist in figuring out just how far he travelled on this memorable journey.

A REBUS.

Transpose a portion of the year, A Christian name will then appear; The same, transposed again will show

A plant that does in India grow. May, Amy, Yam.

How do you define a ring? As a hole with a rim around it.

What did Adam and Eve do when they were expelled from Eden? They "raised Cain."

What town is most frequently drawn? Cork.

What kind of a receptacle is that which is always asking permission to move? Can-i-stor.

What would you advise a person to do who had some money and a buggy-top? Buy a fine tooth-comb.

What part of a fish weighs most? The scales.

When you fine vessel on the ocean speeds, Unto my first the watchful tar's attending;

And yet my second oft employs his thoughts, When at my whole his powerful form is bending.

Cypher Ans. 23, 9, 14, 4, 12, 1, 19, 19.

Why is a pen like a perverse child? Because it never does wright of itself.

Why is a horse like the letter O? Because g makes it go.

When is a boat like a snow bank? When it is adrift.

Which animal requires the most baggage, and which two the least? The elephant takes his trunk, the fox and cock only a brush and comb.

What relation is that child to its father who is not its father's own son? His daughter.

Why is the boy that disturbs a beehive like a true Christian? He is an anxious bee-leaver.

Why are two heads better than one? Because they are fore-sighted.

Why is a cart-horse always in the wrong place? Because you have put the cart before the horse.

What has many leaves but no stem? A book.

What two letters make a prophet? C R.

Why is a black woman like a doorway? Because she is an egress (an egress).

Why do cabmen prefer tall ladies to short ones? Because the higher the fare (fair) the better they like it.

Why is a newly-married couple like a pair of sugar tongs? Because they are two spoons joined.

Which is better! getting the gir, or youf choice or half a loaf of bread? Half a loaf of bread; as nothing earthly can be better than getting her you love, and we know that half a loaf of bread is much better than nothing.

Spell one word with the letters: In magic tale. Enigmatically.)

Spell one word with the letters: Tis no demon's art. (Demonstration.)

A REBUS.

My first, gentle lady, you give to the youth, Who now breathes the fond wish of his soul; Whom with ardent affection, and honor and truth, You perceive is indeed in my whole.

In my snug little second, secure from the storm, We the the helpless and innocent find; And my whole when a contract or bargain you form, You should give, the agreement to bind.

Cypher Ans. 5, 1, 18, 14, 5, 19, 20.

CONCEALED GEOGRAPHY.

14. A friend, named Dorcas, owned a red raven named Jehoshaphat.

15. I sailed past Africa, Oceanica I rounded, and came to America.

16. Adam, as customary in Paradise, snubbed Eve.

17. A good nap lessens the length of the day.

18. Napoleon begins as a comet, ends as a falling star.

19. Said Henrietta "Unto no man give I my heart."

20. I bet he loses the race.

21. France may not bear this rebuff a long time.

22. Is there a railroad over the top of Mount Washington?

23. If we drink too freely of the cask, age racks us with pain.

24. Tell King William to send some officer of rank for the answer of Jules Favre.

25. The ravings of the mob I leave to your imagination.

26. To get gold to par is the Secretary's prime object.

27. I saw a little maiden very gayly clad.

28. The Harvard Base Ball Club is composed of nine vehement strikers.

29. Rent on Cornhill is low, but rent on State street is high.

30. She was so fond of beer, she baked her pancakes in it.

31. Which do you like best, fricasseed frog, or ham and eggs?

32. In the days of Queen Elizabeth, Lehens & Co. were jewellers in London.

33. The artist should work with art for duty, not pleasure.

Spell one word with the letters: Tis no demon's art. (Demonstration.)

SAM LOYD'S



NEWSBOYS' PUZZLE

It appears that five clever newsboys formed a partnership and pooled their issues to lay in a good stock of papers, which they rattled off like hot cakes and then figured up their accounts as follows: Tom Smith sold one paper more than one quarter the whole lot, while Billy Jones disposed of one paper more than a quarter of the remainder. Ned Smith sold one paper more than a quarter of what was left, and Charley Jones disposed of just one paper more than a quarter of the remainder. A this stage of the game the Smiths were just 100 papers ahead, but little Jimmy Jones the youngest kid of the bunch, sold all that were left, so in this friendly encounter the Jones won out by how many papers do you think?

A REBUS.

Four letters form me quite complete,
As all who breathe do show;
Reversed, you'll find I am the seat
Of infamy and woe.
Transposed, you'll see I'm base and mean,
My name betrays my race;
Transposed once more, I oft am seen
To hide a lovely face.
Cypher Ans. 12, 9, 22, 5.

A CHARADE.

A vowel with two beasts unite,
You'll have what poets often write.
There are two equally good answers to this charade, 5, 16, 9, 7, 18, 1, 13, or 1, 14, 1, 7, 18, 1, 13.

What chasm often separates friends? Sar-casm.

Why is O the only vowel sounded? Because all the rest are in-audible.

Why is coffee like an axe with a dull edge? Because it must be ground before it is used.

Why is an old coat like an iron kettle? Because it represents hard ware.

Why is a dressmaker a most deceptive woman? Because she is not what she seams.

A RIDDLE.

Perhaps you may know
That two centuries ago
My name in the world was unknown;
But now 'tis allowed
In the midst of a crowd
I am met with in every town.
Though varied each lot
In life I have got,
Yet nothing my course e'er endangers;
And wherever I go
So familiar I grow
That I am nodded to even by strangers.
I am cunning and bold.
For young or for old
I fear not but brawl out aloud;
Pugnacious you'll say,
For I knock down by scores in a crowd.

A REBUS.

Though small I am, yet, when entire
I often set a house on fire;
Take off one letter, and 'tis clear
I then could hold a herd of deer;
Dismiss one more, and you will know
That once I held a strange cargo.
Spark.



Mrs. Smith says you must leave at least one more letter each morning or she will patronize some other postman.

A REBUS.

My primal is found where the wild waves are dashing,
And thick falls the cold briny spray;
My final is seen, where the fierce eyes are flashing,
And fortunes are oft thrown away.

To draw your conclusions by spanning my whole,
As to what lies beneath or concealed,
Will oft prove as false as the base flatterer's soul,
When facts, stubborn facts are revealed.
Cypher Ans. 19, 21, 18, 6, 1, 3, 5.

A CHARADE.

Without my first you cannot stand,
My second you may now command;
Together I attend your will.
And am your humble servant still.
Cypher Ans. 6, 15, 15, 20, 13, 1, 14.

What kind of a hen lays the longest? A dead hen.

I will ask the young folks to enjoy a simple study in concealed geography by locating the poor postman's trouble, as illustrated in the following picture:

You see, some charitably disposed schemer had been working an endless chain racket on an unsuspecting public, and was receiving such an immense correspondence that other ladies in the neighborhood became jealous, so the letter-carrier's patience reached the limit when Mrs. Smith threatened to patronize some other postman if she did not get more letters!

ÆSOP'S EAGLE

CLASSICAL PUZZLE
BY SAM LOYD.



Æsop, who lived some twenty-five hundred years ago, was a slave belonging to a noble Athenian, who, being struck by his originality and marvelous gift of inculcating morals or cutting satire in his stories of birds, animals and fishes, brought him to the notice of Croesus, King of Lydia. Among his oldest fables is the story of the ambitious eagle, which resolved to fly to the sun. Every morning as the sun rose in the east the eagle would fly towards it, going a thousand miles before the hour of noon, when the sun would be on the meridian, thus as the sun would pass on towards the west the eagle would continue its hopeless chase, and just as the sun would disappear below the western horizon the eagle would find itself back to the original starting point.

The story is all right as told, but his mathematics are slightly out of gear, and present a pretty problem for our puzzlists to study over. In the early start towards the sun, they are both advancing towards the meeting point, and we will accept the intimation that the sun goes five times faster than the eagle, so they will speedily be on the meridian, but a stern chase is a long chase, so the afternoon race will be the longer one, and will carry the eagle 500 miles farther west every day, so that it will be many a long day before Æsop's point is actually accomplished and the foolish eagle returns to the starting point after making a complete circuit of the globe.

The circumference of the earth being known, and it being assumed that the eagle flies at a height from the earth's surface which does not

materially affect the distance, it is shown that the eagle would go 500 miles further west each day. Let us start the bird on his tour from the dome of the Capitol at Washington, Wednesday January 1st, 1896, on which day of the week would he return to the starting point?

Here is the way a Dutchman gave the problem: "Suppose two geese start from opposite windows of that dome at Washington, what direction would they have to fly to meet again in the shortest possible time?"

Third proposition: Do you know why it is that if you saw an Island exactly one hundred miles away due north-east, you would never get there by sailing due north-east?

NEW YEAR'S RESOLUTION PUZZLE

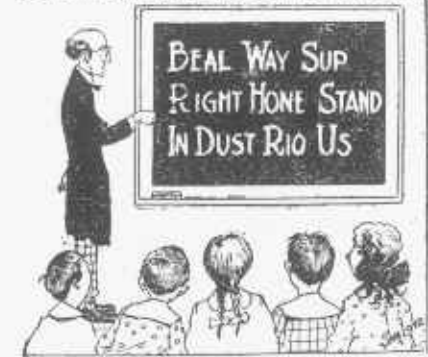

The Puzzleland Sunday School Teacher is giving the children some good resolutions with which to begin the new year. It is a good idea to inject a little difficulty into the lesson so as to impress it well on the memory. Of course, it is any easy puzzle for the little folks, nevertheless let us see if you are clever enough to read it right off.

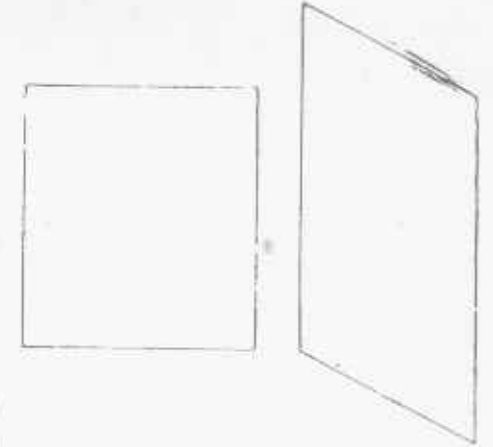

How to Make Diamonds

The juvenile readers will find in the following an interesting method of passing an hour or two out of school hours or to amuse an evening party. All that is needed is a pair of scissors and some paper which may be cut into the form of a parallelogram or rectangle as shown in the above illustrations:

The puzzle is to discover how either one of the forms can be divided into equal halves which will fit together so as to form a perfect diamond. As both diamonds will be of equal dimensions, it shows that the above forms are of the same size. It would have been a more difficult puzzle to have required you to prove the forms to be of the same size by merely cutting them into halves. It will be found that they are built upon different ideas, although based on scientific principles of geometry well worth knowing.

Of course, it is understood that no paper is wasted, as the diamond, when completed, will be just as large as the present figure.

Cutting puzzles of this kind are always popular and instructive in that they exercise the inventive faculties and serve as an elementary drawing school.

A Rebus

As to what lies beneath or concealed,
Will oft prove as false as the base flatterer's soul,
When facts, stubborn facts are revealed.

Cypher Answer.—19, 21, 18, 6, 1, 3, 5.

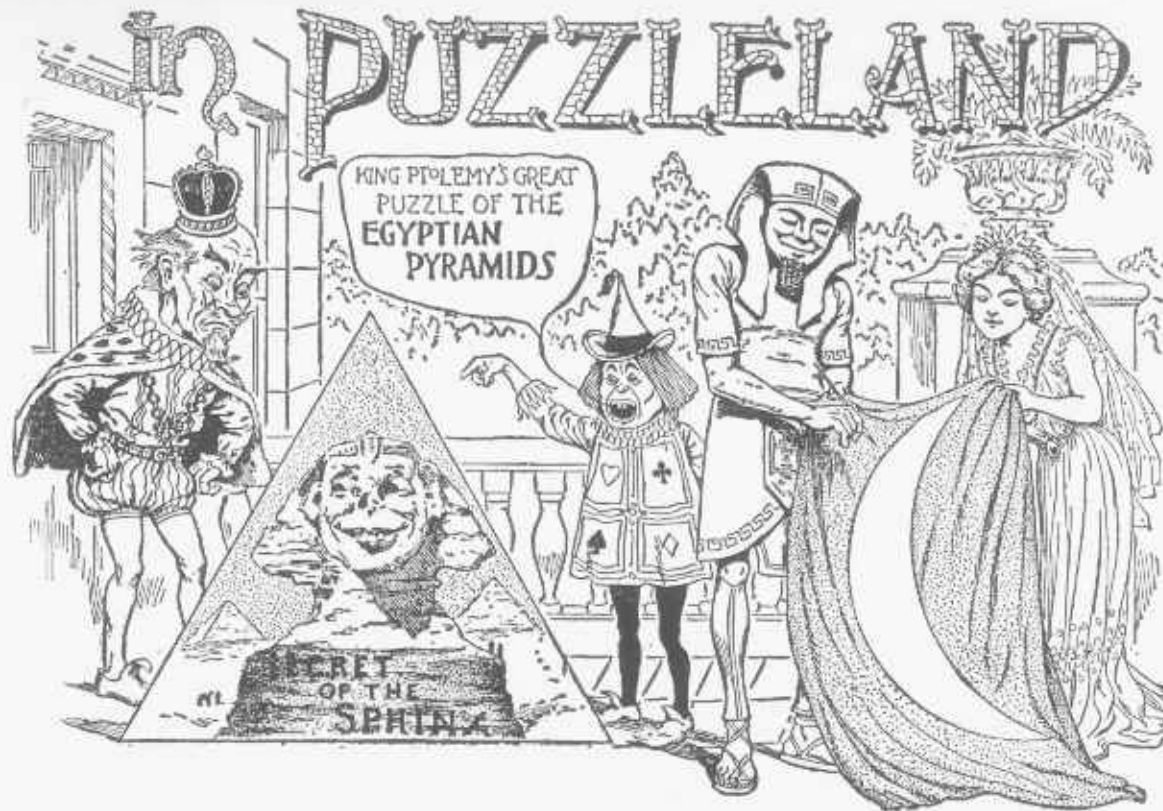

Here is King Ptolemy's great puzzle of squaring a pyramid, which for thousands of years has been known as the mysterious secret of the sphinx. Take an equilateral triangle (the three sides of equal length) and divide it into the least possible number of pieces which will fit together so as to form a perfect square.

How the veteran puzzlists who realize the truth of that time honored motto: "once a puzzlist, always a puzzlist," will recall the happy hours spent in translating the old fashioned picture-proverbs, like the following, which our grandfathers delighted to show us:



ALL ABOUT A PENNY

Many years ago when conducting a pioneer puzzle department in the weekly edition of a daily newspaper (which idea has become so popular that all of the great dailies and weeklies have their puzzle columns). I gave a little coin puzzle which had an extensive run. The young folks were invited to see how many objects could be discovered in the above representation of a penny. To simplify the puzzle, however, I now give the names of the objects and merely ask you to locate them. 1. The name of an animal. 2. A kind of fruit. 3. A place of worship. 4. A beautiful flower. 5. Part of a jug. 6. Badge of officer. 7. Part of a hill. 8. Personal pronoun. 9 Part of a trunk. 10. Part of a whip. 11. Badge of royalty. 12. Part of a pitcher. 13. That for which our forefathers bled. 14. A venomous serpent. 15. A protection against thieves. 16. An American Ambassador. How many more can you find in addition to these?



"Give me three skeins of silk and four of worsted," said little Susie as she placed 31 cents on the counter, which was the correct amount.

Thinking she had the right to do a little shopping on her own account after the style of her mother, she remarked "I think I will change my mind and take four skeins of silk and only three of worsted."

"Then you are just one cent shy," remarked the shopman. "Oh no," said little Susie as she skipped out of the door with the goods, "I think you are just one cent shy!" What was the price of silk and worsted?



OF COURSE every one knows Bixby the enthusiastic puzzlist, who just revels in tricks and conundrums; who can twist a pun or riddle out of every word you say, and who is always loaded right up to the muzzle with puzzle gems which he terms "diamonds" when they are appreciated, and "pearls" when they fall flat, as they sometimes do.

He got called down so abruptly the other day that the shock was actually painful. It seems that there was some exciting news from China, and, as the boys were shouting extras on the street, Mrs. Bixby, who has a brother in Pekin, induced Bixby to go after a paper. He was on the point of relieving her anxiety regarding the fate of the missionaries, when, according to custom, he first glanced at the little department of bright sayings and found something which particularly struck his fancy.

"Oh, say, dear," he commenced, "I have got something funny to tell you. I have got two letters which show the

name of a state, and—" "I know what those letters are," exclaimed his better half, and they illustrate your conception of what is funny. One is a letter which I gave you two weeks ago to mail to mother, and which explains why she has not come, and the others were to Aunt Phoebe and the Haverstraw people, telling them we were out of town; so here we will have them on our hands to-morrow, and the children down with the measles and whooping cough!"

The more Bixby explained that it was only a little puzzle to spell the name of a state with two letters the worse he floundered, for he now recalled the other letters which he had forgotten to mail.

But to get back to our puzzle, how many of you can show that the name of one state can be spelled with two letters, while two other states may be spelled with three letters each?

Arithmetical Puzzle.

Take four, numbers, all alike, and arrange them so as to add up 100.

Literary Rebus.

FIRST SYLLABLE.

"Look how the floor of heaven
Is thick inlaid with patens of bright gold.
There's not the smallest orb that thou beholdest,
But in his motion like an angel sings
Still quiring to the young-eyed cherubims."

—Shakespeare.

SECOND SYLLABLE.

"Near yonder thorn, that lifts its head on high,
Where once the signpost caught the passing eye,
Low lies that house where nut-brown draughts inspired;
Where gray-beard mirth and smiling toil retired,
Where village statesmen talked with looks profound,
And news much older than their ale went round."

—Goldsmith.

THIRD SYLLABLE.

"A mighty wave rushed o'er him as he spoke,
The raft it covered and the mast it broke;
Swept from the deck and from the rudder torn,
Far on the swelling surge the chief was borne;
While by the howling tempest rent in twain
Flew sail and sailyards rattling o'er the main."

—Pope.

A Square Word Puzzle.

1. A recess.
2. A lazy fellow.
3. Girl's name.
4. Flocks.
5. To rub out.

Answer to the above:

N I C H E
I D L E R
C L A R A
H E R D S
E R A S E

A Charade.

My first will range the meadows through,
In savage pride and state;
But should he make my next at you,
Your danger would be great.
My whole in russet cap is found,
And robe of lovely green,
Tall, springing from the marshy ground
Like some bright fairy queen.
Cipher Answer.—

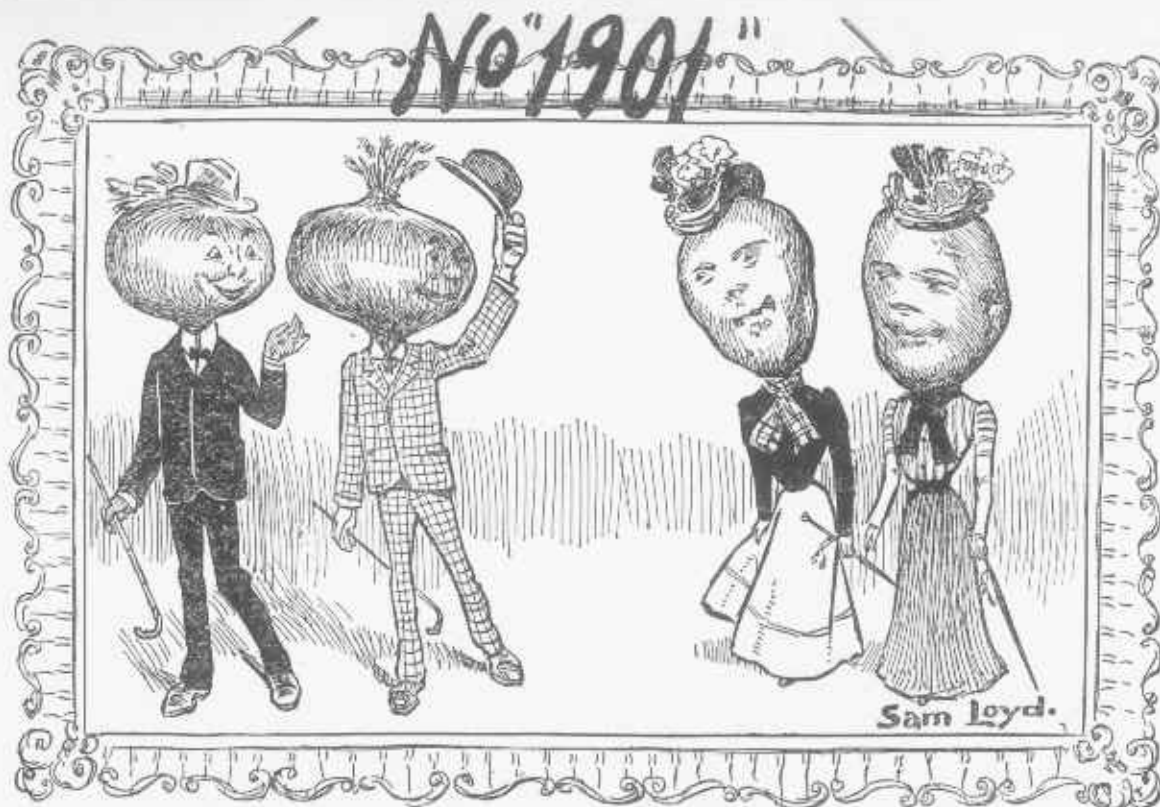

NO. 1901 ART PICTURE

I have at least succeeded in getting one of my pictures on the walls of the academy this season, and while I have been overwhelmed by the compliments of my friends, I have been struck by the lack of appreciation or taste in art matters by the public at large.

I was there opening night and could not help overhearing the remarks of some of the flippant critics.

"I wonder how much the painter of that thing expects to get for it?" asked one young lady of her escort, who is a dauber who has tried for years to get a canvas accepted. "Well, I don't know," replied the puppy; "but I should think that three years would be about right!" Two picture-dealers seemed to be interested in it, so I listened to their remarks. Says one of them: "I wonder why they hung that thing?" "Perhaps because they could not hang the artist," replied the other; and then the first, who was really not the fool he looked, said a remarkably good thing which is worth preserving: "Do you know what would be a good name for the picture?"

His reply was so clever that it

is presented in the nature of a conundrum: what would be an appropriate name for the picture?

COULDN'T TELL A LIE



"George Washington!" exclaimed his irate Mother, "your father says he never turns his back without his cigarettes disappearing. He left a full box on his desk when he went to the village this morning for a bracer, or some kind of a tool he wanted and when he came back, half of them were gone. While he spoke to the men folks about it, a half of what were left disappeared. He went over to Franklin's place to get some fusil oil to wet some sort of a whistle he was fixing and when he returned, once more they had been halved. Then he comes and complains to me, just as if I had been smoking, and now finds just one left, and

you tell me that you did not touch one of them?"

"Mother," said the truthful son, "that one that's left is the one I didn't touch," and when his fond parent ambled homeward to cut a cherry switch, he got there first and cut the little tree off close to the ground and hid it.

Now then, as a historical fact, can you not see that this little incident proves just how many cigarettes they used to put in a box in those days?

A MARKING PUZZLE

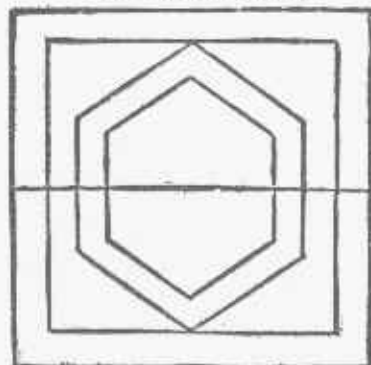

Draw the above figure with one continuous mark without crossing a line. A difficult fact is to place a piece of paper before a mirror and draw the design while looking at the paper through the mirror.

THE INSPECTOR'S PROBLEM

THREE PYRAMIDS BALANCED WITH EIGHT CUBES ON THESE DISHONEST SCALES



HE MADE ANOTHER BALANCE LIKE THIS. THEN HOW MANY PYRAMIDS WOULD BALANCE WITH EIGHT CUBES UPON HONEST SCALES?



Inspector Jones' duty is to prove the correctness of weights and measures throughout the town; to see that the poor coal man is not giving half a ton too much; that the conscientious butcher is not robbing himself by giving over-weight, and that the much abused iceman is not actually defrauding the Ice Trust. But in this particular instance he is up against a tickleish problem, he finds a pair of scales which are decidedly off-centre as they term it; the scales are "weighted" so as to balance, although the fulcrum is not in the middle—an error which the unsophisticated grocer is liable to overlook.

You must not judge from appearances in this case, as Benjamin Franklin wisely said, for with a puzzle-makers' license I have drawn the scales so as to give no clue to the puzzle.

In the first trial three pyramids balance with eight cubes of wood, but when he places one cube on the long arm of the lever it balances with three pyramids!!

Assuming that a pyramid weighs one ounce, what should have been the true weight of the eight cubes?

A Charade

My first's an ugly insect,
My next an ugly brute:
My whole an ugly phantom
Which naught can please nor suit.
Cipher Answer.—2, 21, 7, 2, 5, 1, 18.

Missing Words.

The blanks in this little quantain are to be filled in with words spelled with the same seven letters:

No — to glory, he — the blows

Of the — that threaten his life;
Then quickly — to an inn that he knows,

Where the host is no — of strife.

The answer to the above remarkable anagram puzzle, which gives no less than five seven-letter words, to be arranged from the same letters are:

Aspirer, Parries, Rapiers, Repairs and Praiser.

Ancient Egyptian Puzzle.



Many versions have appeared in verse and prose of the story of the ancient Egyptian king who promised the hand of his beautiful daughter to the man who could shave down the sides of a perfect cube of wood to fit respectively into a square, an equilateral triangle and a circle, constructed in proportions shown in the accompanying illustration. Many scholars, scientists, mathematicians and other learned men of that time thought they could solve the problem—but the beautiful princess died an old maid after all.

Probably our young puzzlists are cleverer than the ancient Egyptians, and may be able to find the solution. To find answers it is not necessary to actually whittle a cube of wood, simply mark out on a piece of paper three sides of the cube and indicate what cuts, if any, you would make to fit the sides into the square, the circle or equilateral triangle respectively.

SAM LOYD'S CANDY PUZZLE



Tommy, Willie, Maggie and Ann bought twenty pieces of candy for twenty cents. Fudge costs four

cents a box, while gum drops were four for a cent and chocolate drops two for a cent.

How did they invest their money?

THE LITTLE BROWN JUG

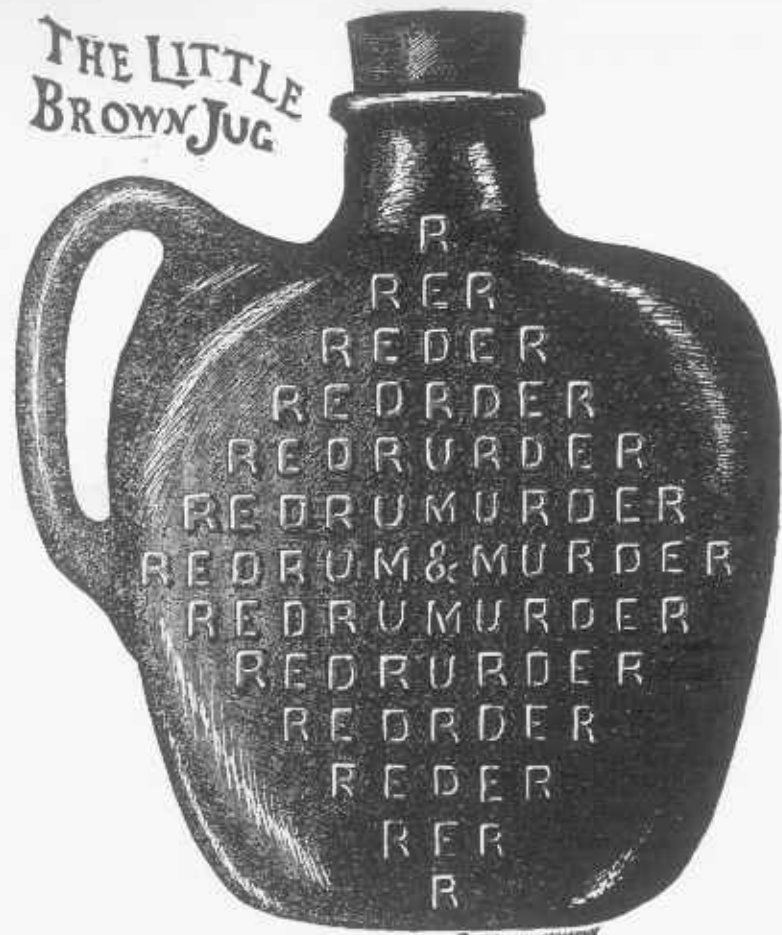

PROPOSITION—How many ways can you read the words red rum and murder?

IN FORMER DAYS, when word puzzles were in vogue, much study and brain work was given to the construction of words or sentences which would read the same backward as well as forward. They were known as "palindrome" puzzles, which is a word derived from the Greek palin, backwards, and dromein, to run. There are many words, like level, eye, gig, etc., which read the same either way, but the aim was rather to construct palindromic sentences, like Adam's noted greeting to Eve, "Madam, I'm Adam," or the sentence, "Name no one man." The idea is of very ancient origin, and there are some classical specimens in Latin and French which are often quoted. There is a famous one ascribed to Napoleon which might be stated as follows: Once, upon being asked whether he could have dictated terms to the whole of Europe, he replied: "J' etais en etat de le faire avant on m'emporte a l'ile d'Elbe."

The puzzle is to translate into an

English sentence which will read the same either way: "Able was I ere I saw Elba."

Here is an old palindromic combination which I perpetrated in my



Pa then saw Esau kissing Kate."

early days for the benefit of a temperance organization, and which will try the patience and skill of our young puzzlists. The problem is to begin from the outer R's and tell just how many different ways one can read the warning words Red, Rum and Murder, without being affected by delirium tremens. Commence from any of the outside letter, spell right into the center and out again on any of the branches and see how many ways you can spell it without making and two sequence of letters alike.

Which of your teeth are like a dressmaker's finger and thumb when she is cutting out a dress? Those in-cisors (scissors).

When is a Scotchman like a donkey? When he strolls along his banks and braes.

When are secrets like the sails of a ship? When they get wind.

How many young ladies would it take to reach from London to Brighton? About fifty-two; because a miss is as good as a mile.

Why is a pack of cards of only fifty-one in the pack, sent home, like a pack of cards of fifty-two? Because they are sent in-complete.

False Alarms.

Here is a sketch of a scene which Harry, known as "l'enfant terrible," took occasion the other evening to describe. His father and mother were alarmed one night by what sounded like house breakers. The locality is hidden in the description of the picture.

Squaring accounts

A temperance puzzle
By SAM LOYD

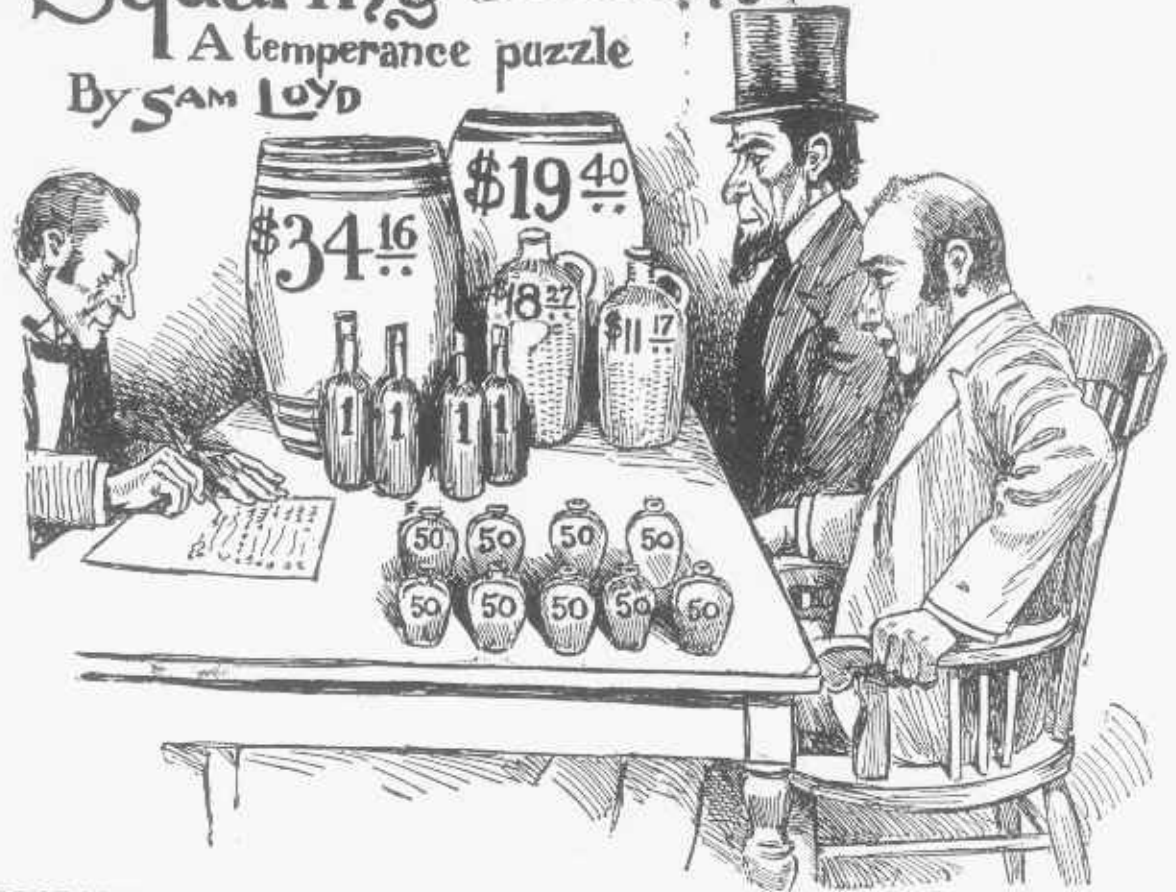

PROPOSITION—Tell how much a temperance town made by going into the liquor business.

THERE IS AN ELEMENTARY puzzle in book-keeping which anyone who has the faintest idea of the principles of profit and loss, should solve mentally just like a flash. I give it because it is said to be based upon an actual occurrence which was referred to me for a decision, and, as all the parties to the transaction held different views, it looked as if it might furnish a capital theme for a puzzle.

It is told that a temperance town in New Hampshire appointed an agent for one year to be the only person authorized to sell liquors. They advanced him \$12 cash, and liquors amounting to \$59.50. In rendering his accounts at the end of the year he showed extra purchases of liquors to the extent of \$283.50. His total sales amounted to \$285.80, on which he received a commission of 5 per cent. in lieu of salary.

The sketch shows the agent and town committee taking account of stock, every item being marked at

retail price. The puzzle is to tell how much profit the town made on its liquors.

A REBUS.

My second, who is a relative, took my first after using my whole at dinner?

Cypher Ans. 14, 1, 16, 11, 9, 14.

Why is a sick Hebrew like an emerald? Because he is a Jew ill.

Why is a printer like the postman? Because he distributes letters.

What is the difference between a sun-bonnet and a Sunday-bonnet? A day's difference.

A turkey, cock or hen;
Behead me, and I upward soar,
Put on my head again,
Transpose me, then a beast I am,
Bloodthirsty, bold and wild,
That preys on many a helpless lamb,
And oft devours a child.
Fowl, owl, wolf.

Why is a dog's tail a great novelty?
Because no one ever saw it before.

A REBUS.

I cheer the pilgrim's lonely way,
As toils he on from day to day;
Curtail me, and I then am found
What students do on college ground:
Curtail once more, and by inspection
You'll find I am an interjection.

What kind of a diary is productive of harm? Incedniary.

A word there is five syllables contains;

Take one away,—not one of them remains!

Mo-no-syllable.

If an acrobat falls in a ditch, why is he likely to miss the beauties of summer? Because the fall follows right after the Spring, and he misses the Summer-set between them.

Pray, tell me, ladies if you can,
Who is that highly favored man,
Who, though he has married many a wife,

May still live single all his life?
A clergyman!

THE PONY CART PROBLEM

BY SAM LOYD



PROPOSITION—What was the circumference of the circular track.

THERE IS ONE OF those curious and instructive problems which we are apt to pick up at any time during a morning's walk, and which is apt to furnish food for reflection for the rest of the day. Recently, while enjoying a walk with a friend in the country we met his son, who, while driving a speedy pony, went around a sharp turn at a gait which threatened an upset to the pony cart, as well as to his father's nerves. In the discussion which occurred later on, after we had returned home, there appeared to be such a diversion of opinion between father and son regarding the turning qualities of that pony cart, to say nothing about the danger of upsetting through going so fast, that we did some little experimenting in a practical way, during the course of which we developed the following problem:

The sketch will aid, not only to explain the nature of the puzzle, but will afford such of our young puzzlists as depend on their judgment and common sense to make a pretty good guess without resorting to figures or the rules for computing concentric circles.

In turning the pony cart around within a ring of a certain diameter, which might be said to be reasonably safe, it was found that the outer

wheels made two turns to the inner ones' one; the wheels were fixed at the statutory distance of five feet apart on the axle-tree. The problem is to guess the circumference of the track described by the outer wheels in making the turn.

For an accidental puzzle, picked up in the road, as it were, and pertaining to matters with which it is assumed that we are all tolerably familiar, it is a pretty one, well worth the attention of our experts.

Missing-Word Puzzle.

Here is an odd little criss-cross puzzle wherein you are to discover a word, which when placed in the vacant space, so as to be read twice, will make the sentence complete, beginning at **THE** and ending with **ESCAPED**.

Why does the Russian nation resemble the sea? Because her nobles are tremendous swells, and her people serfs.



PROPOSITION—How old will Smith be?

SMITH IS THE ACTUARY for a life insurance company, and is so imbued with mortuary tables and columns of dates that he talks and dreams of little else. He hurries home so as to spring a statistical problem in the family circle, the more especially for the benefit of his wife, of whose mathematical powers he is prone to speak disparagingly. She caught him, however, a short time ago on a compact which will have the effect of muzzling him for some time to come, and may possibly cure him of talking shop at home.

After propounding one of his statistical conundrums, which did not meet with the enthusiastic reception which he thought it merited, he boastfully remarked that if his better half would give him any problem on dates or ages which he could not answer in ten minutes he would pledge himself not to propound another problem until the anniversary of that day. He probably meant for one whole year, but, as the proposition was made on the 29th day of February last, and leap years don't have yearly anniversaries, he was held to a literal interpretation of his promise.

The problem with which his wife gagged him, so as to keep him in a moody trance, was as follows: "Now, Tom, supposing that you were three times my age when first we met, and that I am now just the age you were then, and that when I

am three times my present age our combined years will amount to exactly one hundred, can you tell just how old you will be on the next 29th day of February?"

It was an impromptu problem, but a very good one, as is it not quite so easy as it looks.

Why will an insolent fishmonger get more business than a civil one? Because when he sells fish, he gives sauce with it.

What are the greatest obstacles to a Russian invasion of Turkey? The baulkin' (Balkan) mountains.

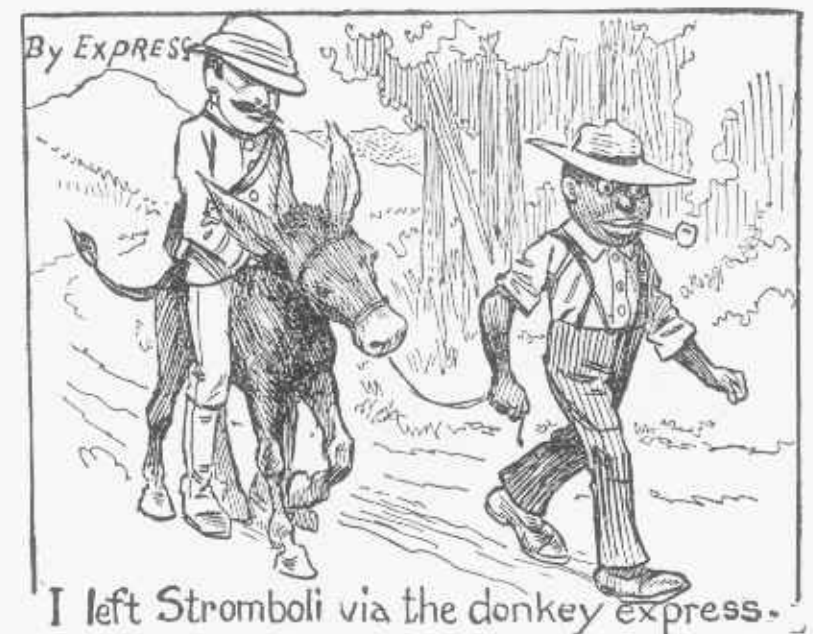

BY EXPRESS.

As a study in concealed geography I will ask the young folks to help me out in the following little matter. Some time ago I met a lineal descendant of Baron Munchausen who told me such a thrilling story of an express train being held up by bandits in a southern country that upon meeting a traveler from the same place I questioned him regarding the dangers of traveling. He said it was fatiguing and inconvenient, but in no way dangerous. There were neither railways nor stages even, between the points mentioned, as every one had to travel over the mountains by express, by which is meant to sit astride of a sharp backed donkey without saddle or stirrups. The paths are so steep and narrow that the little donkeys fall continually, so the traveler must be prepared to land on his feet at any moment.

I made the accompanying sketch from his description, and will ask our young puzzlists to discover the locality of Munchausen, Jr.'s, incident, concealed in the description of the picture.

From a number that's odd cut off the head
It then will even be;
Its tail, I pray, take next away:
Your mother then you'll see.
Seven.

Why is the horse the most humane of all animals? Because he gladly gives the bit out of his mouth, and listens to every woe.

A QUESTION OF PEACHES, PEARS, PERSIMMONS and PLUMS BY SAM LOYD.

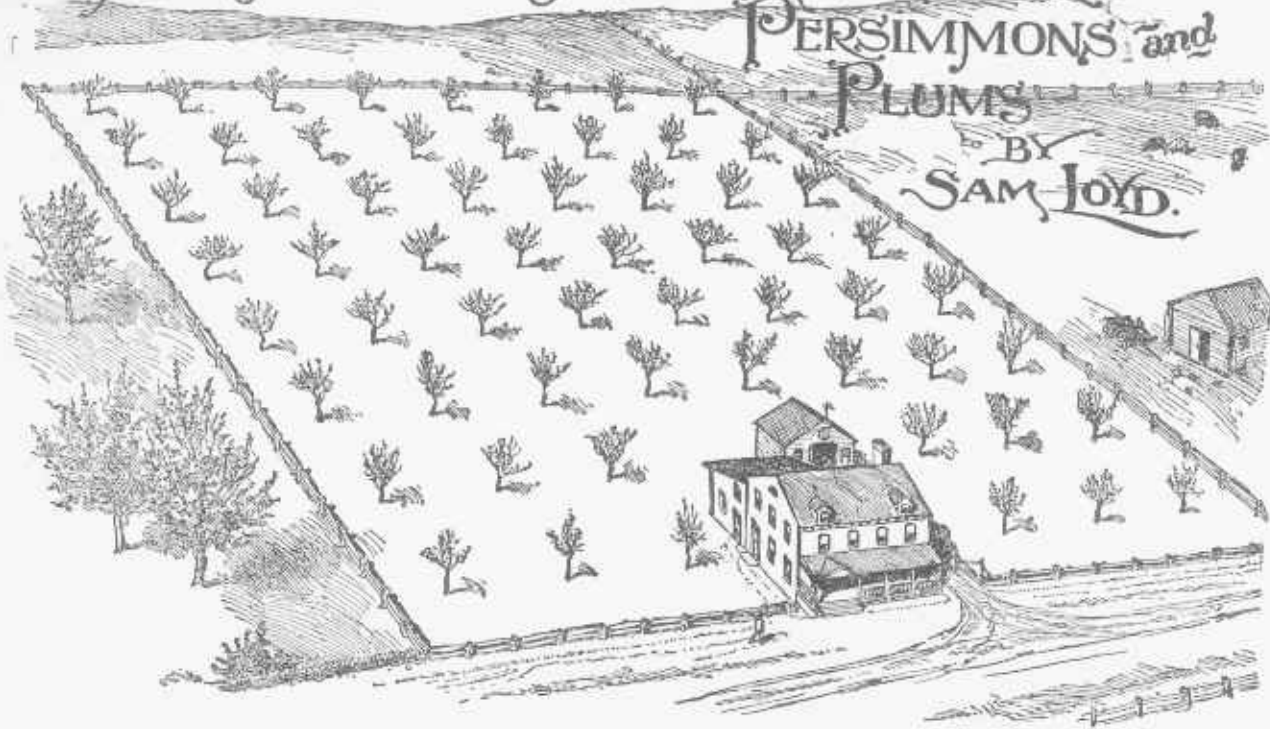

PROPOSITION—How many groupings of different kinds of fruit can be located in the orchard?

ONCE KNEW AN EC-centric old gardener who had a hobby for setting out his young fruit trees according to a secret code, so that no one but himself could locate the several varieties of trees in an orchard. He gave as a reason that he was engaged in experimental grafting and did not care to let visitors or even those in his employ into the secrets of his craft. He was continually inventing and devising new methods for concealing the location of trees which were undergoing certain experimental grafting, and, as a matter of fact, used to put away the chart or clue to the secret, even from himself, so as to see if the developments of his experiments would be sufficiently marked to disclose their locality.

The last time I saw him he had just set out sixty young trees adjoining his house, as shown in the accompanying picture, and it may be of interest to mention that these sixty trees were what is known as quince stock, upon which the different varieties of fruits are grafted. It had always been a fad with him to set out ten trees of a kind at one time, but to scatter them in different parts of the orchard, located according to some sort of secret system,

which would place ten trees in five rows of four in a line. It is quite a pretty little puzzle to lay out ten trees in such a way that there will be five rows of four in a line, and a still more difficult feat to duplicate the trick so that one group of trees will not interfere with another of a different species.

He always maintained that the principle might be carried still further, so as to bring in other groupings, and asked me to work it into a puzzle to see if any of our puzzle experts could help him out.

The problem, therefore, is to see how many groupings of different kinds of fruit can be located in the orchard as shown. There must be ten trees of each kind of fruit, so arranged that there will be five rows of four-in-a-line of each fruit.

I have suggested the names of peaches, pears, persimmons, and plums, hoping that the plan of the four groupings may be discovered.

In working out your solution mark out a diagram upon a sheet of white paper, dots representing the trees, and each tree marked with the name of the fruit; or the solution may be shown by writing in the names under the trees in the picture. Of course, in showing the groupings of the four sets it would require but

forty of the sixty trees shown—the sixty trees in the picture merely show where the selected forty may be placed.

What does a man love more than life,

Hate more than death or mortal strife;

That which contented men desire,
The poor have, and the rich require;
The miser spends, the spendthrift saves,

And all men carry to their graves.
Nothing.

Why is a chicken-pie like a gunsmith's shop? Because it contains fowl-in pieces.

When do your teeth usurp the functions of the tongue? When they are chattering.

Why is Buckingham Palace the cheapest palace ever built? Because it was built for one sovereign and furnished for another.

Which is heavier a half or a full moon? The half, because the full moon is as light again.

When does a cow become real estate? When turned into a meadow.

Why is it impossible to pick the best horse in a race? Because there is always a better.

Professor Blumgarten and the Peace Congress Prize Puzzle BY SAM LOYD

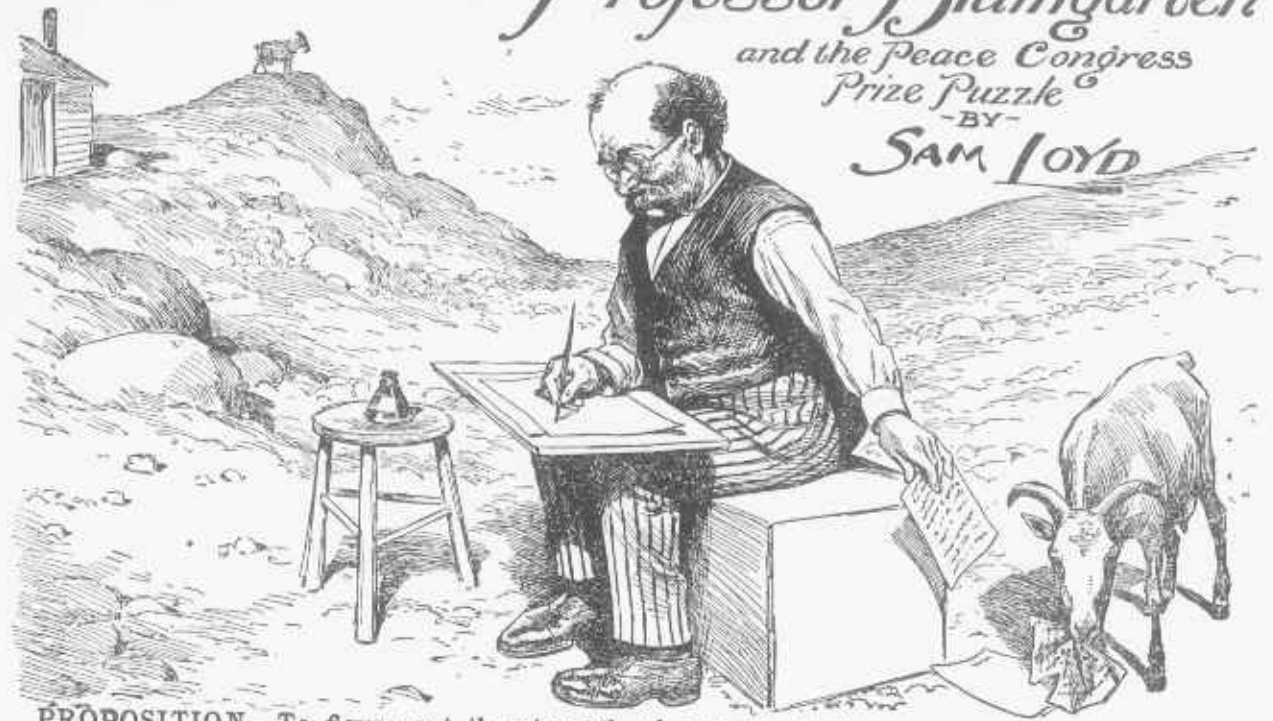

PROPOSITION—To figure out the strength of a goat's skull.



HERE IS THE PUZZLE which Richard H. Proctor, the astronomer termed "the most curious mathematical problem on record."

"Even if the peace congress should precipitate a conflict between the European powers," said Professor Blumgarten, "it would be a move in the right direction, for it would set the people to thinking, and that is what we are after."

"In this enlightened age it is the height of folly for two nations to go to war over a matter which could be settled by arbitration. It is a simple calculation to figure up the fighting resources of two quarrelsome nations, to count the number of men, guns and financial resources, and say to the weaker: 'You are whipped by just 200,000 men, 300 cannon and \$500,000,000, which you can pay to the international walking delegates of the Arbitration Committee.'

"It is only between nations, men or animals of nearly equal strength where it is difficult to select the superior. Expert arbitrators could determine those fine points. You never see a small dog attack a large one; it is only the fool dog that can't calculate who gets whipped.

Bicycle races and chess matches could be settled in the same way.

The chess forces represent a perfect equality, so the result of a contest could readily be determined by comparing the square root of their mental capacities.

"I found out the true principle of arbitration and universal peace by watching the goats in Harlem. A big goat and a little goat will live together in harmony, because they have nothing to dispute about, but just as soon as two goats of so nearly the same size as to give rise to a question of boss-ship, meet, the fool of the two is killed. Sometimes it ends like the tragedy of the Kilkenny cats:

"There once were two cats of Kilkenny,

Each thought there was one cat too many.

So they quarreled and spit, and scratched and hit,

Till, excepting their nails and the tips of their tails,

Instead of two cats there weren't any.

"I once witnessed such a duel to the death between two goats, which shows the wonderful sagacity of the animals, and at the same time introduces as pretty a mathematical problem as the average puzzlist cares to tackle. A neighbor of mine had a goat which held the undisputed championship of the rocks for sev-

eral seasons, when some one was so unfortunate as to introduce a new goat which weighed just three pounds heavier. The first weighed 54 pounds, the newcomer 57, and as a goat knows enough not to fight out of his class, and they never fight at catch weights, to all appearances they started in to live harmoniously. But the little fellow planned a piece of deep strategy. He stationed himself at the top of a pretty steep pathway, and from that point of vantage hurled defiance at his rival in a way which the latter could not brook, so he started up the hill on a run and was met by the other, who had the advantage of a downhill run. Sad to tell, both goats were killed by the shock of the collision. Now comes the curious feature of the problem, for George Abercrombie, who wrote a considerable work on the raising of goats, says:

"By repeated experiments I have found that the strength of a blow equal to the momentum of 30 pounds falling 20 feet, will just break the skull of a goat, so as to kill it." Accepting this remarkable calculation, coming from a distinguished scientist and mathematician as being correct, I shall ask what must have been the respective velocities of the two goats when they meet, so that they just broke one another's skulls?"



THE "NOUGHTY RIDDLE."

PROPOSITION—With six straight lines complete the sentence.

NO, THIS IS NOT A picture of a little cigarette fiend blowing smoke rings; it is simply an illustrated riddle about which there was considerable smoke and very petty fire.

According to the newspapers a certain bright young school mistress used to amuse her pupils by sketching illustrated riddles upon the blackboard, one of which was the picture shown, which, by the addition of six straight marks will tell just what that little boy is saying.

Well, it transpired that a certain muddle-pated dominie who had never heard of this famous old puzzle, got it mixed up with an old chestnut about reading mad dog backwards, which he was familiar with, and actually brought the puzzle into court to have the school mistress discharged!

The puzzle, as you all know, is to add six straight marks to the eleven noughts, so as to tell us just what that little boy said to the dog, hence the name of the naughty (not naughty) riddle.

SAVING LIFE.

I was reading the account of a man in a boat who saved himself by throwing everything overboard, and as his better half was not mentioned in the salvage, it struck me that a literal interpretation of the account was suggestive of a good puzzle theme. The picture is a faithful

description of the scene as described by the survivors, but the puzzle is to discover the locality concealed in the explanation of the frantic husband.

What piece of coin is double its value by deducting its half? A half-penny.

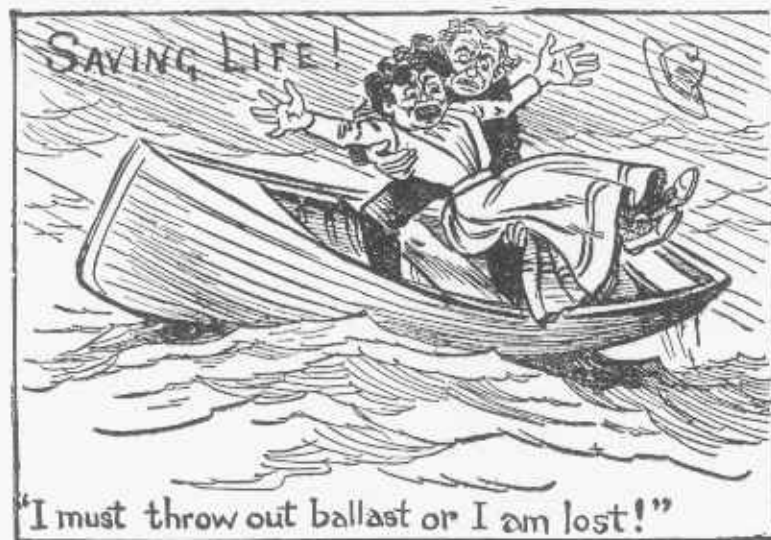

The Philanthropist



PROPOSITION—Why is an old horse like a philanthropist?

BBETTER PUZZLES, conundrums, riddles or tricks which exercise the brains, sharpen the wits and teach the young folks to recognize the bright and clever side of things as they journey through life. When Sidney Smith was importuned by a persistent young lad to give him a puzzle he could not solve, the great wit said: "I am neither fish, flesh nor fowl, yet I frequently stand on one leg. If you behead me I stand upon two, and, what is more strange, if you behead me again I stand upon four, and I shall think you are then related to me if you do not now recognize me."

I have adopted riddles and conundrums as the elementary introduction to the world of puzzledom, and shall introduce thousands of clever conundrums for beginners to read and ponder over. Don't always

try to solve them. Just look at the answers so as to see and appreciate



"I won't take care of this baby longer than today!"

the point. When you become familiar with them you will learn to master them instantly and will soon begin to originate conundrums and puzzles of merit with ease.

A prominent philanthropist and officer of the Society for the Prevention of Cruelty to Animals, who is enjoying the ocean breezes at Atlantic City, is noted for his ready wit as well as kindness and liberality. He has acquired a curious habit of speaking to all dumb animals just as if they understood him and will at times carry on quite an animated conversation and propound queries which would puzzle some of the animals of the higher order. During an early morning walk the other day he found a poor old horse which had been retired from active service, with which he struck up quite an acquaintance, or, as he termed it, a close relationship.

"My dear brother," he asked, as he patted the animal's head, "do you know why a faithful old horse is like a philanthropist?" As I failed to catch the horse's reply, our young puzzlists are asked to solve the conundrum.

What is that which is bought by the yard and worn by the foot. A carpet.

How do bees dispose of their honey? They cell it.

To encourage a love of geography, I will ask our young students to discover the locality of this little incident, as concealed in the excited exclamation of the frantic maiden who has charge of dear little Tootsey Wootsey during our summer outing.

His two stock jokes.



PROPOSITION—Solve these two conundrums.

DURING MY SUMMER outing I picked up the following odd piece of history which bears out the claim that one trick, with the knack of showing it cleverly, or even a couple of conundrums trotted out at opportune moments, will give a stupid fellow a life-long reputation for smartness: Captain Woods, who for many years used to pilot the little steamboat so close up under the falls of Niagara, had two stock jokes which were sprung on every trip, and which lasted him during his eventful life.

Of course, veterans who made the trip in days of yore will remember the jolly captain and his pet cat, as well as his two jokes, which penetrated with the driving mists through their oilskin caps. It al-

ways commenced and ended in the same way. Moving his hand care-

fully along the side rail of the boat, as if examining the woodwork minutely, he would look up inquiringly and ask: "I say, stranger, do you know what this boat is made of?"

"Why, pine or oak, isn't it?"

"No, sir-ree, sir! Nor it ain't hemlock nor cedar, neither. And can you tell me why we call this cat Niagara?"

After you gave up both questions, he would give the answers, and laugh just as heartily as if he had not enjoyed the same jokes right along for nearly half a century.

Can you guess the answers to the two conundrums?

A BIG PAIN.

Not wishing to dissent from the poet of Stratford, who some three hundred and odd years ago told us that—

The poor beetle that we tread upon,
In corporal sufferance finds a pang
as great

As when a giant dies.

I wish to quote my old friend P. T. Barnum, as differing with the above sentiment so often quoted to us in our childhood days when we found pleasure in pulling wings from flies. He used to say that, despite of his great bulk, Jumbo's appreciation of pain was out of all proportion to his size. On one occasion when he was afflicted with a simple green-apple stomach-ache, he howled in such a way as to drown the members of the combined menagerie who roared out of sympathy, and would not be pacified until they sent home for his regular physician. The story is such a good subject for a puzzle idea that our juveniles are asked to discover the locality of the incident, hidden in the description of the picture.

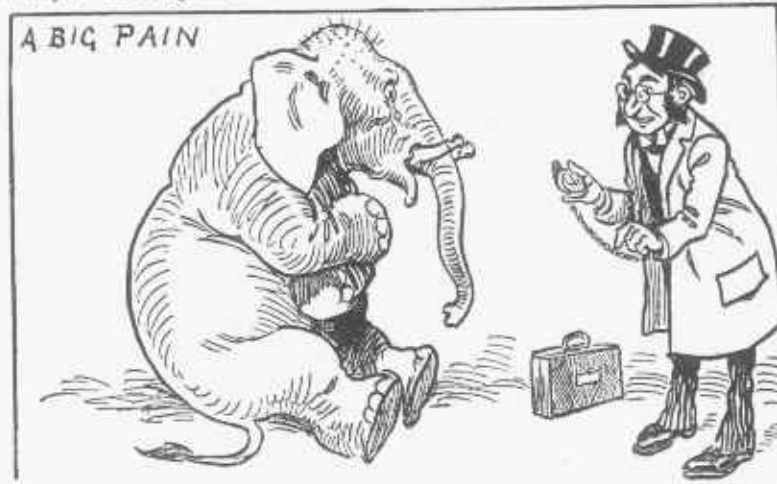

"Now let the Doctor see Jumbo's tongue."

THE CHINEE DONATION PUZZLE BY SAM LOYD.



PROPOSITION—Commencing at some certain letter, discover a connected sequence of the twenty-four letters which will reveal an appropriate motto.

READING PUZZLES, similar to another one called the Dewey pillow puzzle proved to be so popular with our young folks that I will take occasion to describe another of Harry's achievements upon similar lines. Of course Harry and his sister loved the poor heathen Chinese, and cheerfully broke open their money boxes to contribute to the mission fund when their father said they must. But Harry did not enthuse a little bit when himself and sister were delegated to take charge of a donation box at the mission fair and got tired of telling every one it was to provide fire crackers for little pagans who had no Fourth of July. He printed some donation puzzle cards, as he called them, with the names of Ah Foo, Syn Hop and other noted Chinese names worked in, as shown in the sketch, and sold them for a dime each, telling every one that there was a motto to be discovered by a continuous sequence to the twenty-four letters and that every one might have his money back if the motto did not prove to be appropriate and pointed.

It is an ingenious and clever puzzle, which goes far to prove that Harry had studied the foreign Chinese mission question very profoundly for one of his years.

MISCHIEVOUS BUNNY PUZZLE

Here is a simple little picture puzzle for the young folks which shows two jardinières of rare exotics, one

of which has been overturned by a mischievous little bunny. The puzzle is to cut out one of the jardinières on the dotted lines and replace it so as to show the position of the mischievous rabbit.

Why does a young lady prefer her mother's fortune to her father's? Because, though she likes patrimony, she likes matrimony better.





PROPOSITION—How many steps was there to the old tower?

F COURSE ALL itinerant tourists who have taken their summer outing en wheel along the Jersey coast are familiar with the problem of the old Beacon Tower at Point Lookout, about which there is always such a diversity of opinions at different seasons of the year. The ruins, or speaking more correctly the wreck, of the old tower which served as a lighthouse for more than half a century, stands at present in the last stages of dissolution upon a little ledge of rocks which run out into the sea. The accompanying picture is taken from a sketch made some fifty years ago and furnishes data and information which could only be surmised from the present condition of the tower. The picture, as well as the facts, were obtained from an old resident, now in his ninety-sixth year, and recalls the erection of the tower when he was a very small boy. The entire country turned out to do honor to the event and there were few persons in that neighborhood who did not believe that the old Beacon was just a little bit higher than the tower of Babel. There is nothing left now but a charred pole or post some sixty feet high, as the stairs were destroyed by fire twenty odd years ago, but the picture as well as the county records show that it was originally

300 feet high. A very respectable height indeed, when we remember that for over a century the limit of one's powers of conception of height around the city of New York was to say, "As high as Trinity Church steeple," which just vied with the old Beacon Tower. But the times have changed since that era and it was only the other day that the venerable sexton complained that the naughty boys in the adjoining office building were throwing things down on the church spire. The center support was composed of huge poles skillfully spiked together, about which there wound a spiral staircase with an iron rail, which went exactly four times around the column, as shown in the sketch. There was one baluster or picket to each step, and as these pickets were just one foot apart, it should really be a very simple matter to determine just how many steps one had to take to reach the top, and yet to quote the words of Captain Huff, who furnished the picture and history of the tower, "I never yet knew one of them city folks who come out here for the summer who could figure it out right." To the platform of the tower, it was exactly 300 feet high. The stairs circled the column just four times, and as shown in the sketch, was thirty-three feet, ten and a half inches in diameter, from

which the circumference can readily be computed, so as to tell how many steps there were.

A REBUS.

To meet a need, our maid was sent in Haste, my whole is what she went in. Behead, transpose, the thing she bought Appears, and which she safely brought, Curtail, transpose, and take for granted You have the end for which was wanted, Transpose once more, though strange 'tis true, The maiden's name appears in view.

CHARADE.

My first, my second, and my whole, Are every one the same In point of meaning, each and all, An oft repeated name.

What is that which the dead and living might do at the same time? Lie.

Why are A and B's successors a ragged lot? Because they are C D. When does a lady think her husband a hercules? When he can't get on without his "club."

When was Napoleon I. most shabbily dressed? When he was out at Elba (elbow).

What professional men generally work with a will? Lawyers.



PROPOSITION—Can you decypher the illustrated charade?



HERE IS A LITTLE Indian meal for our puzzlists suggested by certain interesting facts pertaining to the census re-

port of Uncle Sam's aborigines possessions. In view of the intimation that poor Lo pertains to a past generation, as the Indians are now on the high road to wealth, and the "untutored minds" have submitted to enforced education, we will take a look at a Winnipeg chief, whose head, like the head of Winnipeg Lake, is full of craft, and ask the simple conundrum: Why is this noble savage a person of education?

Incidentally, to illustrate the advanced course of study introduced by the Indian Commissioner, our puzzlists are asked to decipher the hieroglyphical puzzle which is printed upon the sign board.

Where was Adam going when he was in his thirty-ninth year? Into his fortieth.

When is a disengaged cab like a Yankee witness? When it is on the stand.

THE REASON WHY.

It is reported that during a recent conversation between the Duke of Cornwall and York, surprise was expressed at the popularity of tobog-



How can a dangerous pastime like tobogganing be popular?

gating. When we remember, however, that it was a summery view of a winter sport, drawn entirely from imagination, without a realistic view of the pretty girl who shares the danger, his prospective Royal Highness may be pardoned for preferring to shoot the chutes or loop the loop in a quiet way after the American fashion.

The puzzling feature of the incident, to which the attention of our young folks is directed is to see if they can discover the locality hidden in the description of the picture which is supposed to be a part of the conversation between the Duke of Cornwall and York.

As showing how our English cousins fail to appreciate our Yankee humor when we attempt to precipitate an American bull, it is worth mentioning that I have received scores of letters telling me that the Duke of Cornwall and York are one and the same person!

Why is a hive like a spectator at a show? Because it is a be-holder.

In what does a lawyer resemble a woodcock? In the length of his bill.

My first's a dirty little brute,
My second's at the end on't;
My third, like many an honest man,
Is on a fool dependent.
Pig-tail.

Water soft is my first, water hard is my second,
Sticks made of my whole are by many sweet reckon'd.
Liquor-ice.



A CORNER IN WHEAT.

PROPOSITION—Tell just how many grains of wheat Sessa was entitled to.

ACCORDING TO EN-cyclopediacal lore, the royal game, or what is now known as chess, was invented by a Hindoo named Sessa, and the king of that country, Shevan the Great, asked Sessa what reward he demanded for his wonderful game. Sessa astonished the king by the apparent moderation of his demand, viz., one grain of wheat for the first square of the chess-board, two for the second, four for the third, eight for the fourth, and so on, always doubling for each square up to the sixty-fourth square of the chess-board.

The king accepted the proposition and referred Sessa to his accountant and treasurer, but was astounded to learn that the entire world could not raise sufficient wheat in one hundred years to pay the debt. Sessa insisted upon the payment of his debt and claimed the ownership of all the wheat of the world.

The game was originally called the royal game, but the king in his

mortification named it chess, which, as explained in Webster, is the name of a vile weed which causes the blight in wheat. To the average mortal the amount of wheat which would be required to pay the debt to Sessa is so large that the mind fails to grasp its immensity, yet, when the story was told to Steinitz he exclaimed: "It is not true; no sane man would have sold such a great invention, even for a thousand times as much!"

The game became popular, however, and so developed and strengthened the gray matter in the brain of the king that he was enabled to solve the great Indian chess problem and save his country. Calling Sessa to him he said: "It is an easy matter to tell how much wheat must be given to you, but the same must be counted accurately. So yourself and as many assistants as you care to engage must go to the public granary and carry away all the wheat you can count, but if your count is not correct you will loose

your head for cheating the treasury."

When Sessa found that a man to whom he had to pay half a rupee a day could not count the grains of wheat in a bushel in two weeks, and that he could buy six bushels for a yen, he threw up the game.

There is said to be a royal road to the solution of this problem, which our puzzlists may use if they can discover it; nevertheless it should be an easy problem in simple arithmetic to tell just how many grains of wheat Sessa was entitled to.

A REBUS.

My first is a letter, an insect, a word That means to exist; it moves like a bird.

My next is a letter, a small part of man,

'Tis found in all climes; search when you can.

My third is a something seen in all brawls,

My next you will find in elegant halls

My last is the first of the last part of day,

Is ever in earnest, but never in play,

My whole gives a light by some men abhorred,

The blessings from which no pen can record.

Cypher Ans. 2, 9, 2, 12, 5.

CHARADE.

When Kate the cook prepared the meal,

My first was in request;

My next is seen in Lamb and veal,

A quarter or a breast—

Which with my whole the table graced,

And truly 'twas no wonder,

When at the board each guest was placed,

To see my third thrown under.

A RIDDLE.

Just equal are my head and tail,

My middle slender as can be;

Whether I stand on head or heel,

Is all the same to you or me

But if my head should be cut off,

The matter's true, although quite strange,

My head and body severed thus

Will then at once to nothing change.

Cypher Ans. 6, 9 7, 21, 18, 5, 8.

When is a soldier a very charitable person? When he presents arms (alms).

Why is the earth like a school slate? Because boys and girls multiply on the face of it.

Which is the coldest river? The ice is (Isis).



PROPOSITION—Solve these chair conundrums.

THERE IS A BRIGHT bit of humor which evolves a brace of conundrums well worth the guessing. Dolly invites the milkman to be seated and asks him why the wrecked chair is like his bill? He solves the conundrum and retaliates by asking, "What is the difference between the chair and one of his cows?" Then she asks him: "Why the chair is like this dress?" All of which goes to show the way that love begins between clever people.

When is a butcher a thorough thief? When he steals a knife and cuts away with it.

Why is a pleasure trip to Egypt fit only for very old gentlemen? Because it's a see-Nile thing to do.

A CHARADE.
My first is one, or many men;
My second comes apace;
My whole's a pledge to be redeemed
Within a certain space.
Cypher Ans. 8, 15, 19, 20, 1, 7, 5.

In what respects were the governments of Algiers and Malta as different as light is to darkness? One was governed by deys (days), the other by Knights (nights).

What instrument of war does the earth resemble? A revolver.

What is the most warlike nation? Vaccination, because it is always in arms.

Why is a retired carpenter like a lecturer? Because he is an ex-planer.

Why is a bad picture like weak tea? Because it is not well drawn.

What did Adam first set in the garden of Eden? His foot.

Why is a new-born babe like a donkey's tail? Because it was never seen before.

What is the difference between a sweep and a poor man in a new suit of mourning? One is blacked with soot, the other suited with black.

When is a soldier not half a soldier When he's in quarters.

A REBUS.
I hope you have two of my first;
My next we will term an extreme;
My whole pertains to ancient tales,
Wild, and romantic as a dream.
Cypher Ans. 12, 5, 7, 5, 14, 4.

Students of geography are asked to discover the scene of this nightmare concealed in the description of the picture.

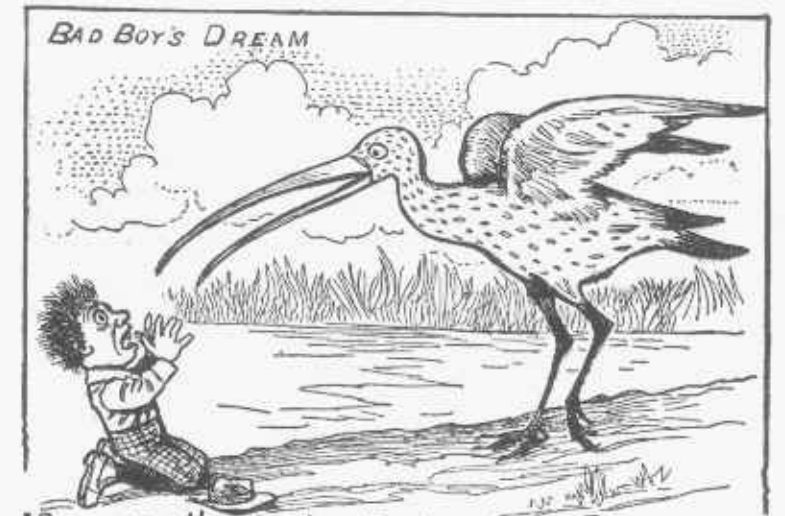

If you are the Curlew I stoned yesterday, I am awfully sorry."



THE CHRISTMAS TURKEY.



PROPOSITION—How long a chase has the turkey led Jolly Old Santa Claus?

HERE IS A PRETTY puzzle for the juveniles which affords considerable scope for ingenuity and cleverness. This Turkey Gobbler has led "jolly old Santa Claus" a merry chase around the field, as shown by the tracks in the snow, before he was caught. You can see that they entered from the right side and did some lively circling before arriving at their present position, where the gobbler seems to be upon the point of surrendering. Our young folks are asked to study the situation carefully and to tell just how many times Santa Claus must have turned completely

around, during the chase, before pouncing upon the Turkey?

CHARADE.

In every hedge my second is,
As well on every tree,
And when the school-boy acts amiss,
It often is his fee.
My first likewise is always wicked,
Although it does no sin,
My total for my first is fitted,
Is made of brass or tin.
Cypher Ans. 3, 1, 14, 4, 12, 5, 19,
20, 9, 3, 11.

Why are stout gentlemen subject to melancholy? Because they are men of size (sighs).

When is a candle in a passion?
When it is put out or flares up.

Why is a talkative young man like a young pig? Because, if he lives, he is likely to become a great bore (hoar).

Why are laundresses good navigators? Because they are always crossing the line and going from pole to pole.

What is the difference between a tube and a foolish Dutchman? One is a hollow cylinder and the other a silly Hollander.

What is the difference between a good soldier and a fashionable young lady? One faces the powder and the other powders the face.

THE FLYING BIRD.

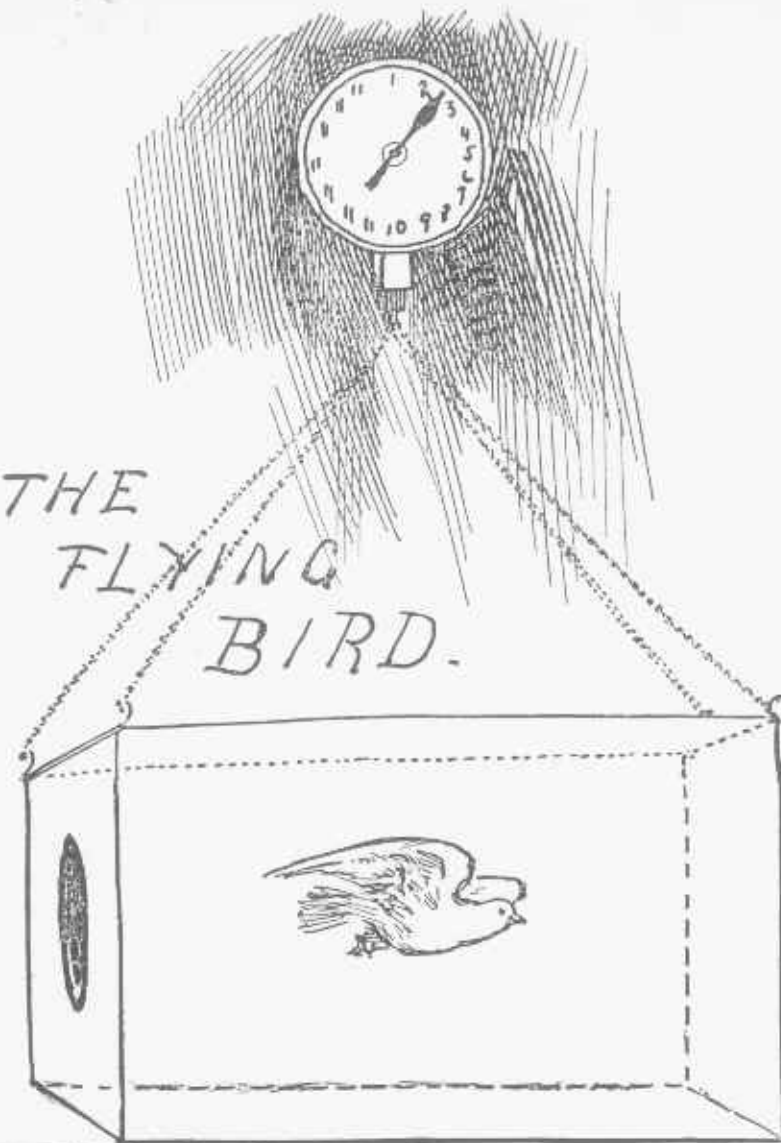

HERE IS AN ODD little problem which turns upon a point of natural philosophy and common sense mechanical laws, with which every one is supposed to be familiar. There is no catch about it, nor any necessity for putting salt on the bird's tail that I am aware of, and I do not know that I am better qualified to answer the question than any one else. It came to me from Princeton College with the simple query: "Supposing that a bird weighing one ounce flies into a box with only one small opening, and without resting continues to fly round and round in the box, would it increase or lessen the weight of the box?" I give it as pertaining to a class of instructive questions which I think should be propounded and answered by all who are interested in natural and mechanical science. I will

cheerfully give my own views on any proposition fired at me, and stand, like the rest of the class, liable to be caught on the wrong side of the argument.

A Rebus by Cauning.

There is a noun of plural number,
Foe to peace and tranquil slumber
But add to it the letter s,
And —won'drous metamorphosis—
Plural is plural now no more,
And sweet what bitter was before'
Cares—Caress.

SEEING THE COUNTRY.

Perhaps the clever ones will explain a mystery which turns upon a concealed locality. I never could understand just why or where the Italians get the bears and monkeys which they bring over as a fitting part and parcel of their itinerant musical caravansaries, for, so far as I am aware, there is neither a bear nor a monkey to be found in the whole of Italy, outside of one or two meagre zoological gardens, and yet there exists in the heart of every Italian peasant a deep-rooted hope that he will some time or other be able to buy a bear and a monkey, which will enable him to see America.

One fellow told me of a brother who had met with great success in conducting a show somewhere in the South. He had forgotten the name, so I just make a sketch of that Italian conducting his show, and ask our young puzzlists to discover the location of that wandering brother, in the description of the picture.



He tramped the country with a cub and a trained monkey.

CROSS-COUNTRY-RUNNING

PROBLEM BY
SAM LOYD.

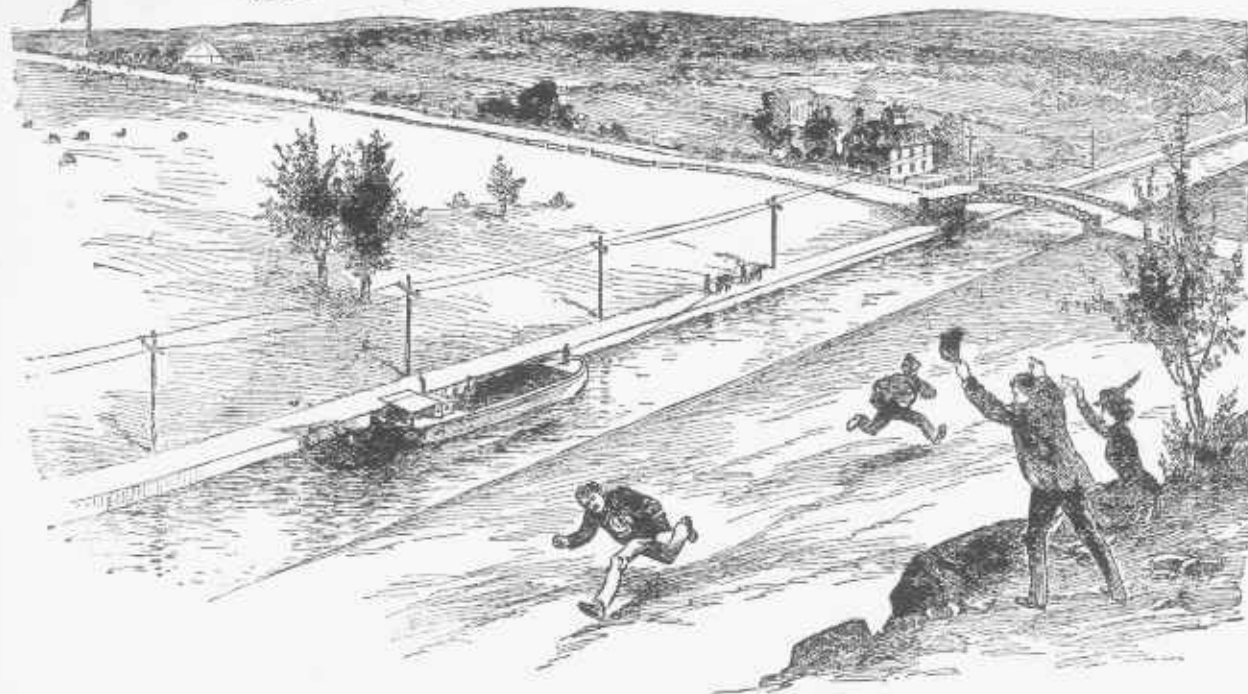

PROPOSITION—Tell how far apart are the bridges.

THERE IS A PROBLEM from the popular pastime of the "Hare and Hounds," which will interest the young folks, while at the same time it may cause the sluggish blood to course anew in some of us old-time paper chasers with pleasant recollections of cross-country feats of our college days.

The sketch illustrates a clever and successful ruse of the hound in capturing the hare. The boy running this way is the hound and he is chasing the other fellow, who is supposed to be one of the hares. In the picture it does not look as if the hound was after that particular hare, as they are running in opposite directions.

He is chasing him, however, and very successfully, too, as you will readily see when the ruse is explained, for that is where the point of the problem comes in.

The hound was pursuing the hare, but in place of catching it found that he could just hold his own—in other words, the other fellow was just as good a runner as he was and it was a hopeless task to try to catch him by a direct follow, as he had a good lead of twenty-five yards.

"Home" is shown far back in the picture, marked with an Ameri-

can flag. The hare is 250 yards from the bridge, from whence a straight run of 600 yards at right angles brings him to safety.

It looks hopeless for the hound, doesn't it? But just at that moment the hound realized that there was another bridge to the left, which cannot be seen in the picture, and that by crossing this bridge and taking a cut across the field, through that drove of cows, this hypotenuse line might possibly be shorter than the other one. It was a successful ruse—a sort of happy inspiration, so to speak—for after he had made the successful run and collared his hare, we measured the distance and found that from the exact spot where the hare is now shown to be, the two routes would be equally long. By spinning in the opposite direction, therefore, the twenty-five yards lead was transferred from the hare to the hound, who crossed the other bridge, cut across on the line of the hypotenuse and came in just twenty-five yards to the good.

Of course everyone can see it now, but the puzzle now is to tell just how many feet that hound has to run before he comes to the lucky bridge, which is not shown in the picture.

This problem is presented to our

college students and high school boys, as well as all others mathematically inclined, for the purpose of teaching a simple rule well worth knowing.

Why is a blacksmith's apron like a convent? Because it keeps off the sparks.

Why does a blacksmith never eat his apron? Because it goes against his stomach.

Why is a wick of a candle like Athens? Because it is in Grecco (grease).

Why is a fender like Westminster Abbey? Because it contains the ashes of the grate (great).

If you were obliged to swallow a man, what kind of an one would you prefer to swallow? A little Dublin porter.

What four letters of the alphabet would frighten a thief? O I C U (oh, I see you).

Why must a magistrate be cold and chilly? Because he is just ice (justice).

What is the difference between a new five-cent piece and an old-fashioned quarter? Twenty cents.

What is the cheapest way to buy a fiddle? Buy a little medicine and get a vial in?

What profession is a postman? He is a man of letters.

The Golf Puzzle

BY SAM LOYD



PROPOSITION—Guess the proper distance to drive the ball.



F COURSE EVERYBODY is playing golf now, and even the lazy ones, who, a few weeks ago, declared how much pleasanter it was to swing in a shady hammock and watch the others plodding around the golf links, have caught the golf fever and are chasing the ball around the golf links with their minds full of thoughts of how much pleasanter it is to chase the ball around the golf links than it is to be swinging in a shady hammock and to be thinking how much pleasanter, it is etc., etc., D. C., ad lib. But be that as it may, what I mean to infer is, that they have all got it, and unless you are prepared to discuss all the wrinkles and systems of golf, or take in with well-assumed appearance of credulity tales of feats which would make Baron Munch-usen blush to the core, you might as well ruminant at home in a shady hammock, etc., etc. I am not much of a golfer, but have been picking up points for a great combination system. One fellow offered to teach me the sharp points if I would "caddy" for him, which

reminded me of the boy who worked his passage from the West on a canal by leading a horse. I have struck a genius who has evolved a winning system based on mathematics. He says: "Just cultivate two strokes of different lengths, one a drive, the other an approach, and play direct toward the hole, so that a combination of the two distances will get there."

What should be the proper length of strokes to learn, to win out in the least possible number of strokes on a nine-hole course, of 150 yards, 300 yards, 250 yards, 325 yards, 275 yards, 350 yards, 225 yards, 400 yards and 425 yards?

When is a dog most like a human being? When he is between a man and a boy.

How does a boy look if you hurt him? It makes him yell Oh! (yellow).

Why didn't the last dove return to the ark? Because she had sufficient ground for remaining away.

Why is a specimen of extra fine handwriting like a dead pig? Because it is done with the pen.

What does a husband do who misses a train by which he promised his wife to return? Catches it when he gets home.

What coat is finished without buttons and put on wet? A coat of paint.

What is the greatest surgical operation on record? Lansing, Michigan.

Why are fixed stars like pens, ink and paper? Because they are stationary (stationery).

Why should a person not like to gaze on the Niagara forever? Because he would have a cataract in the eye.

What bridge is warranted to support any strain? The bridge of a fiddle.

Why are laws like the ocean? The most trouble is caused by the breakers.

Why does an aeronaut dislike to speak about his trips? It is a soar point with him.

Why is a Chinaman never at a loss for a word? Because he always has his cue.

What is the most popular paper at the summer resorts? Fly-paper.

The Chinese Cash Puzzle BY SAM LOYD



PROPOSITION—To tell the cost of the puppy dog!

AFTER ARRIVING AT a happy understanding with our Celestial neighbors, regarding the payment of the indemnities demanded for the attacks upon our missionaries, and having convinced them of the necessity or advantage of beheading themselves in preference to doing battle with the combined armies of the world, a little light may be thrown upon their methods of finance, as illustrating in a small way some of the difficulties which confronted our peace commissioners in the settlement of the award of damages.

The Chinese coined money thousands of years before the Christian era, but their inability to comprehend the fundamental principles of currency has led them at times into wild and experimental extravagances. In the Flowery Kingdom large transactions are paid in gold ingots, stamped with the date and name of the banker, but the currency of the country consists of taels or cash of fluctuating value. They made the tael thinner and thinner, until 2,000 of them piled

together was less than three inches in height. In like manner the common cash, which is a brass coin with a round, square or triangular hole in the middle, and worth but little more than a mill of our money, is of variable thickness. They compute their value by stringing them on a wire, so as to measure their height in chips or bits, which necessitates considerable aptitude for mental arithmetic in their ordinary transactions, as shown by the following pretty problem which is offered as a fair example:

Supposing that 11 coins with round holes are worth 15 bits, while 11 square ones are worth 16 bits, and that 11 of triangular shape are worth 17 bits, tell how many round square or triangular pieces of cash would be required to purchase that fat little puppy dog, worth 11 bits?

It would be a simple problem to estimate in dollars and cents, but in its present form proved to be an instructive lesson to our Pekin commissioners in the settlement of indemnities.

When is a fowl's neck like a bell?
When it's rung for dinner.

Why is a crow the bravest bird in the world? Because it never shows the white feather.

Why is a vote in Congress like a bad cold? Because sometimes the eyes (eyes) have it, and sometimes the noses (nose).

What kind of medicine does a man take for a scolding wife? He takes an elixir (an' he licks her).

Why is a tramp like flannel? Because he shrinks from washing.

Why does a horse eat in a very odd way? Because he eats best when he has not a bit in his mouth.

What is the only organ without stops? A woman's organ of speech.

What is the proper length for a young lady to wear her dress? A little above to feet.

What is the difference between a pitcher of water and a man throwing his wife over a bridge? One is water in the pitcher, the other is pitch her in the water.

What confection did they have in the ark? Preserved pairs (pears).

What is the difference between a French pastry cook and a bill sticker? One puffs up paste, the other pastes up puffs.

MIXED TEAS BY SAM LOYD



PROPOSITION—What are the proportions of green tea to black?



THE BLENDING OF teas with the Orientals is such an exact science that the production of certain flavors resulting from the combination of different kinds of teas is figured down to the millionth part of an ounce! And it is said that the formulas which belong to some noted growers of tea have been kept secret for hundreds of years and cannot be imitated so as to avoid detection.

Just to illustrate the accuracy and importance connected with the science of blending teas and to show the difficulty of penetrating the mystery with which the art is surrounded, attention is called to a simple puzzle based upon two blends, which suggest some idea of the complications pertaining to the mixing of half a dozen varieties.

The mixer has received two cases, perfectly square, but of different sizes, the one of green and the other of black tea, and has mixed them together so as to fill twenty-two square chests of equal size. What are the proportions of green tea to black? It looks as "childlike and bland" as a sum in simple addition which can be answered in a thousand

ways, and so it can, for it merely turns upon guessing the size of two cubes which will hold exactly as much as twenty-two smaller cubes! See! One large chest of black tea and a smaller chest of green tea. The contents being mixed together is divided into twenty-two square chests. Tell the proportions of black and green tea and you will have mastered the pretty problem of Tschén Si.

A grammatical puzzle.

"Let the rich, great and noble banquet in the festal halls,
And pass the hours away, as the most thoughtless revel:
Then seek the poor man's dreary home, whose very dingy walls
Proclaim full well to all how low his rank and level."

Now change just one letter in one single word in the above stanza so as to make it a different word, and by that change totally alter the syntactical construction of the whole sentence, changing the moods and tenses of verbs; turning verbs into nouns; nouns into adjectives and adjectives into adverbs, etc.,

and so make the entire stanza take on quite a different meaning from that which it now has, and all by the substituting of one letter in a single word!

This puzzle has baffled many clever puzzlists and literary scholars as well, and yet the marvelous metamorphosis is effected by changing the first L into S, so that it will read: "Set the rich and noble banquet, etc., etc."

Why is a New York milkman like the fish that swallowed Jonah? Because he finds a profit (prophet) in the water.

Why is it easy to break into an old man's house? Because his gait is broken and his locks are few.

What word of six letters admits of five successive elisions, leaving at each abbreviation a well-known word? Brandy—brand—bran—ran—an—a.

What word is composed of five letters, from which, if you take two, one remains? Stone.

Name two English words, one of which, being of one syllable only, shall contain more letters than the other of five syllables. Stretched—Ideality.

THE PROBLEM

TIME

BY
SAM LOYD

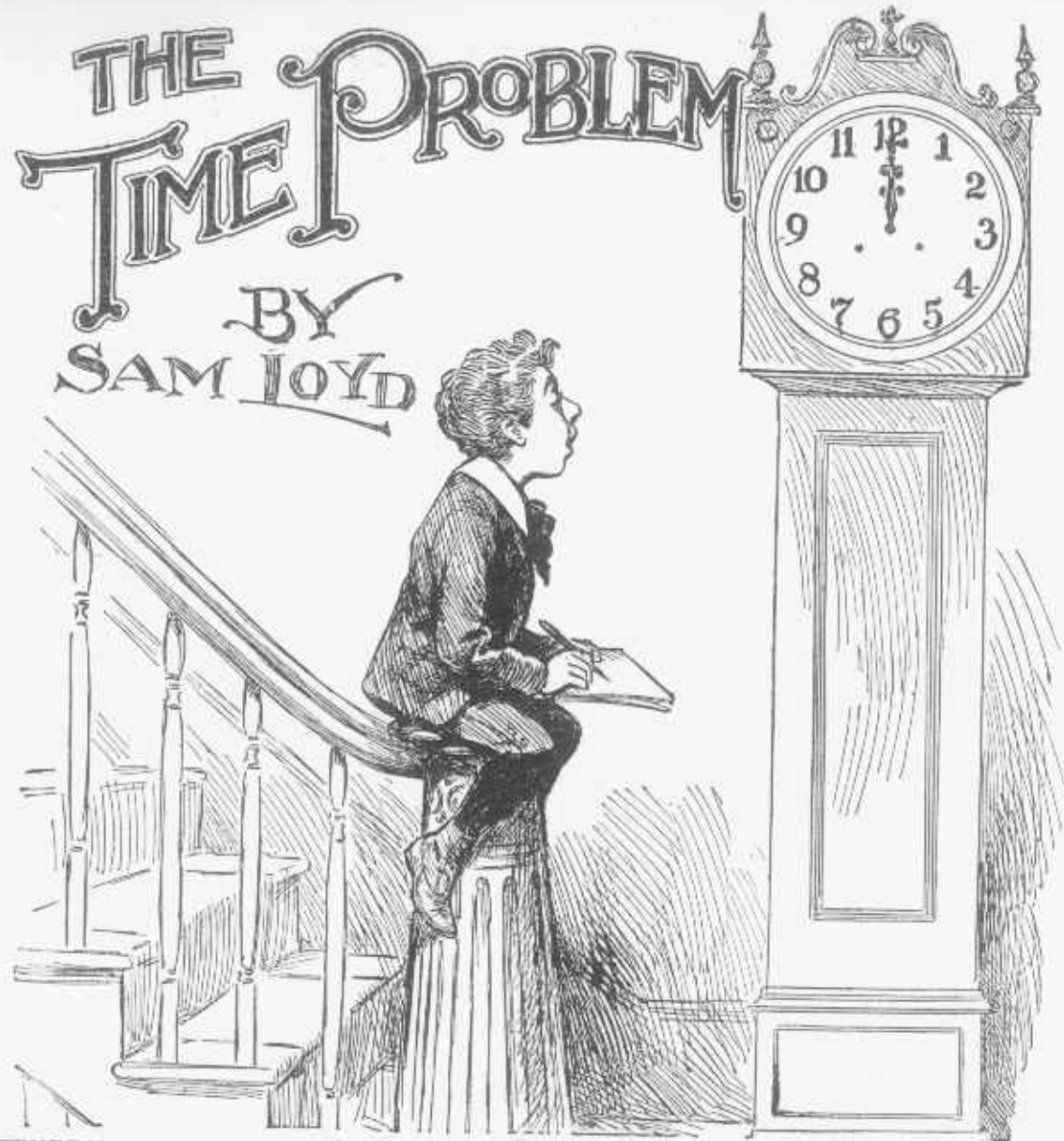

EVERY ONE HAS read about the race between Achilles and the tortoise, so often quoted as showing the impossibility of doing some possible things.

Achilles could walk twelve times as fast as the tortoise, so a match was arranged by Zeno, the philosopher, wherein the tortoise was to have twelve miles start. Zeno maintained that Achilles could never overtake the tortoise, because while Achilles walked twelve miles the tortoise would have advanced one mile, and when Achilles went that mile the tortoise would have gone on the twelfth of a mile, etc. etc.

The story is erroneously quoted by many upon the supposition that while it is evident that Achilles will

overtake and pass the tortoise, that the exact point would be represented by an indeterminate fraction which cannot be computed, but goes on diminishing forever like the decimal value of a seventh. A problem of that nature would be represented by the traveler who journeys from Bagdad to Jerico, agreeing to go half the distance on the first day. The next day half of the remaining distance. The third day half the remainder, etc., etc., always going just half as far as he did the previous day—the result being that he gets very close, but never gets there.

The race of Achilles and the tortoise, however, differs in that he does get there and passes the tortoise, but the difficulty is to determine the exact point.

Tommy noticed that the race

between Achilles and the tortoise represents the relative speed between the hour hand and the minute hand of a clock, so he secures a post of vantage and determines to solve by actual observation a time problem often quoted as unsolvable.

Exactly at 12 o'clock noon the hour and minute hand are together, and the problem is to discover the exact time which the next meeting of the hands represents. As a matter of fact it is a most interesting puzzle which mathematicians recognize as forming the groundwork upon which numerous time problems of an important and fascinating character have been built, for which reason a clear understanding of the principle involved is recommended.

A Square Deal

PUZZLE
BY
SAM LOYD

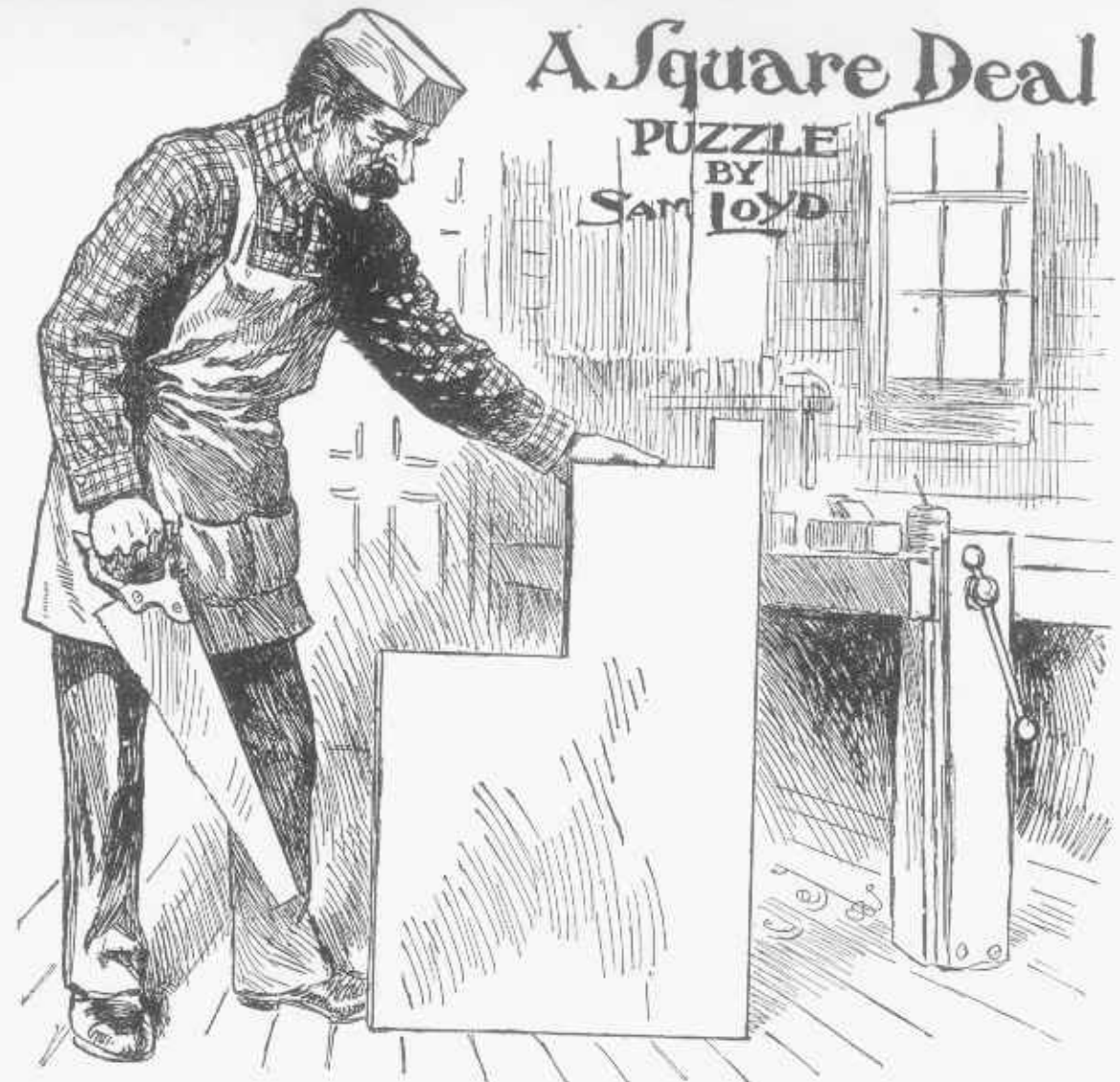

PROPOSITION—Cut the board into the fewest pieces which will fit together to make a square.

THERE IS A PRACTICAL problem from the workshop which shows the advantage of ingenuity and mechanical skill. The carpenter had a fine piece of board which, as shown in the sketch, contains eighty-one squares of the size of the smallest. That is, if the smallest square represented 1 inch, the next would be 16, and the larger 64, making in all 81. He wants to make a perfectly square shutter for his window, 9x9, and, as there is no material to spare, he aims to divide it into the fewest possible number of pieces which will fit together and form a perfect square.

A glance at the board will give you a picturesque idea of the values of gold, silver and copper as formerly advocated in Nebraska, in the ratios of 16 to 1 and 64, with a

mixed or amalgamated copper valuation of 91. From a mathematical standpoint you may learn much in an experimental way regarding the relationships of squares as shown between 1, 16, 64 and 91, which is one of the fascinating features pertaining to the mysteries of square numbers.

Why are cats like unskillful surgeons? Because they mew till late and destroy patience (patients).

Why is a youth trying to raise a moustache like a cow's tail? Because he grows down.

Why is this continent like milk? Because it's ours (it sours).

How may book-keeping be taught in a lesson of three words? Never lend them.

What trade is like the sun? A tanner's.

When is a man obliged to keep his word? When no one will take it.

Why is an attractive woman like a successful gambler? Because she has such winning ways.

Why are stout men usually sad? Because they are men of sighs (size).

Why are two young ladies kissing each other an emblem of Christianity? Because they are doing unto each other as they would that men should do unto them.

What is the color of the winds and waves in a severe storm? The winds blew (blue), the waves rose.

Why is a baker a most improvident person? Because he is continually selling that which he kneads himself.

Why is a stupid fellow like G sharp? Because he is A flat.



PROPOSITION—If the moon was made of green cheese, into how many pieces could you divide it with six straight cuts of a knife?

SPEAKING ABOUT the possibility of treating disease through the influence of will power," says a noted specialist in a recent contribution to a medical journal. "I wish to say that in Switzerland the power of imagination is so strong among the wild mountain swine herdsmen that they will eat their sour brown bread with great relish through believing that they get slices of cream cheese from the moon! They actually go through the motions of cutting the air, and like little children quarrel over imaginary portions."

"Nevertheless," he added, "it was plain to be seen that they were in no way benefited, so far as the putting on of flesh was concerned, by their delusions."

Not being interested in the Christian Science side of the question, I was merely struck by the suggestion of an odd puzzle proposition arising among those peasants as to the possible number of pieces of cheese. Therefore, indulging the foolish fancy of those men as shown in the sketch, let us suppose that the expert carver of the party is speculating as to the greatest possible number of pieces into which he can divide the moon with six straight cuts of a knife. The wild luncheon party are unfortunately reduced to short

rations in having the last quarter of the old moon to feast upon, so they are trying to make the most of it. Are you clever enough to help them?

With a pencil and ruler mark off the pictured moon with six straight lines and see how many pieces you can produce, and if you guess it correctly you will note a difference between this and the famous problem of the Boarding House Pie, as well as the cheese problem which introduced other geometrical principles.

An Oriental Love Story.

He said I was beautiful, he did, I assure you; and I know he was right, for my skin was as soft as satin and white like ivory, my figure slender and elegant.

Our first meeting was in a shop, and he made no attempt to disguise his admiration. He praised me up to the skies and called me "very dear." From that day and for many months we were inseparable. I occupied all his thoughts.

Again and again he gazed with indescribable affection at my wonderful complexion, my graceful figure, and pressed me to his lips.

His embrace was tenderness itself, and whenever some trifling accident marred my beauty—if only for a day—his anxious solicitude

knew no bounds. At night I rested on velvet pillows, and by day I accompanied him wherever he went.

He always enjoyed my society, even when nothing else afforded him pleasure.

He would turn to me, and not in vain, for comfort and relief when all other friends proved faithless. Oh! why was it not fated to be ever thus?

Alas! one day in a public thoroughfare I had a heavy fall, and, though it was through his fault, I was never the same to him as before. This cruel misadventure fairly broke me down. True, he endeavored afterwards to make amends for his harsh treatment.

He treated me with the greatest consideration and loaded me with silver; but the light of former days had gone out.

He tried to leave me as before, but in vain; his feelings had undergone a complete change, and now I am nothing but a miserable wreck of my former self.

Here I lie, all alone in my sorrow, a forsaken, broken—?

This story, which will be "continued in our next," is to be completed by the use of one word. How many of our puzzlists can guess the word which will prove to be a key to the whole mystery?



PROPOSITION—How much wire is there in a ball 24 inches in diameter if the wire is 1-100 of an inch thick?

THERE IS A CERTAIN irresistible Fascination about investigating the affairs of the moon which few can resist, so when the famous Moon Hoax was sprung upon the public during the early part of the last century it was shown that the people were prepared to believe almost anything. It was based upon the alleged powers of a marvelous telescope which, it was claimed, would enable us to see the smallest articles upon the moon's surface. The public seized upon the reports with such credulity that the projectors of the hoax gave vivid descriptions and pictures of the inhabitants of the moon and their wonderful surroundings, so skillfully presented that despite of their extravagant claims were believed for a long time.

The surmises regarding the state of affairs on the moon has been a popular fad with theorists and writers from time immemorial.

Aristo, in his "Orlando Furioso," sent Astolfo on his venturesome trip four centuries ago, and the wonderful stories of what he saw in the "Valley of Lost Things" among

the hills of the moon deceived many. Cyrano de Bergerac's voyage to the moon is one of the most amusing contributions to modern literature, but Jules Verne's account of an aerial trip is the most thrilling of the many lunar legends. The quickest journey of record, however, is that of Edgar Allen Poe's hero, Hans Pfeel, of Rotterdam, who by means of a balloon completed the trip in nineteen hours. It was the detailed matter-of-fact account of this journey which so worked upon the brain of a learned professor named Spearwood that he fitted out an expedition, and actually undertook to make the trip, firmly convinced that at a certain distance he would pass out of the influence of the earth's attraction and pass into that of the moon.

My sketch is drawn from a description published at the time of his ascent, but as the puzzle has nothing to do with the adventure after he had cut loose from his earthly connections, I will say that a pretty problem is found to be involved in the data as given, which does not possess the difficulty which mathematicians would ascribe to it according to accepted methods.

He had a ball of wire twenty-four inches in diameter, the wire being only one-hundredth of an inch thick. It looks like a difficult problem to tell the length of a ball of one-hundredth inch wire, twenty-four inches in diameter, but as a matter of fact it is so simple that it yields readily to common sense, and I should like to see how close our puzzlists can come to guessing the length of wire, without going very deeply into the subject, and shall take occasion in giving the answer to present a simple demonstration practically devoid of mathematics, which any clever child might understand.

Just a Plain Sell.

"How do you pronounce T O?"
 "Too."
 "And T O O?"
 "Too."
 "And T W O?"
 "Too, of course."
 "Well, how do you pronounce the second day of the week?"
 "Tuesday."
 "Really, now, I always thought the second day was Monday."

A Soldier of Metal.



PROPOSITION—Solve three conundrums connected with this picture.

AS RIDDLES AND conundrums are healthy exercise for the gray matter in the brain, we will ask our young puzzlists to guess this pack of seasonal conundrums which were fired off during a celebration of Independence day. It appears that Harry who was taking a walk with his father, asked why that boy had the letter Y on his flag, and the boy who heard this remark asked another boy why that high-stepping kid was a soldier of metal.

Then the father, who knew all of

the boys, asked them why the Fourth of July was like an oyster stew; so we now ask you to answer all three questions.

A CHARADE.

My first will deny the most trifling demand,
My next is what sadly disgraces the land;
My whole, be his station exalted or mean,
Does not to distinction in science attain.

Cypher Ans. 14, 15, 22, 9, 3, 5.

A REBUS.

When the wintry tempests roar,
Hoarsely round the cottor's door,
My cheerful whole its comfort lends,
And for his labor makes amends;
Curtail, and you perhaps may see
That good or ill proceeds from me;
Fountain of virtue or of strife,
I cheer or sadden mortal life!
The extreme letters sweep away,
And I'll receive whate'er you say.

Cypher Ans. 8, 5, 1, 18, 20, 8.

What is the difference between a postage stamp and a lady? One is a mail fee, and the other a fe-male.

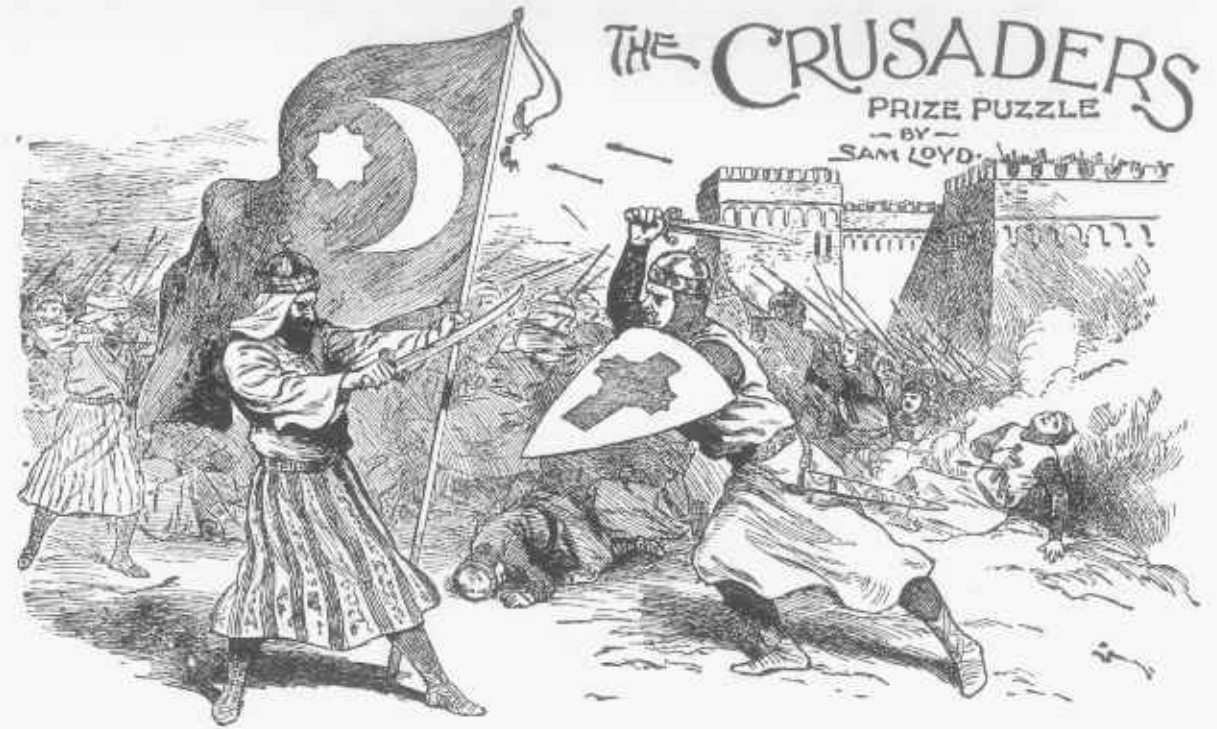

PROPOSITION—Show how the Turkish emblem may be transformed into the Crusader's Cross by dividing it into two pieces.

WE PRESENT AN INTERESTING illustration of the eleventh century, when the noble army of Christians were not withheld by political reasons from rising against the unspeakable Turk, to stop the massacres of the Christian Armenians.

The picture shows an incident connected with one of the great battles of the Crusades, wherein it is related that a body of Christian Knights captured a fortress by assault. "They threw the Saracen soldiers from the battlements, and in full view of the opposing armies changed the banners on the walls."

The story as told would seem to imply that there is a simple way of converting the Mahomedan flag into that of the crusaders, for which reason we place in the foreground a Saracen soldier defending the well-known Turkish ensign against the assault of a knight, upon whose shield may be seen the crusader's cross.

Draw a representation of the Turkish flag, as shown, and then cut out that part which contains the white design, and then in the simplest way, and by cutting into the fewest possible pieces transform the Turkish design into the crusader's cross, as shown upon the shield.

How do you account for the water in the watermelon? The seed was planted in the spring.

Why is the letter S like a pert repartee? Because it begins and ends in sauciness.

What is the best way to keep a man's love? Not to return it.

When is a soldier a wagon maker? When he makes a wheel.

How was Admiral Dewey's naval rank reduced when he got married? He became Mrs. Dewey's second mate.

Why is a little dog's tail like the heart of a tree? Because it's farthest from the bark.

Why does a freight car need no locomotive? The freight makes the car-go.

What is that which is put on the table and cut, but never eaten?

A pack of cards.

Why may not the proprietor of a forest fell his own timber? Because no one is allowed to cut when it's his own deal.

What is the difference between twice twenty-two, and twice two and twenty? One is forty-four, and the other twenty-four.

Tell a man to write down, without hesitation, in figures, twelve thousand twelve hundred and twelve dollars? We hope he will do it correctly. Thus: \$13212.

Why is a blockhead deserving of promotion? Because he is equal to any post.

Tell us, why was William Tell like a post? Because they couldn't get a bough out of him.

Why is a missionary like a pig roasting on a spit? Because he goes around doing good.

What would a pig do who wished to build himself an habitation? Tie a knot in his tail, and call it a pig's tie.

If the before-mentioned porker wished to demolish the pig's sty he had built, what quotation would he make? "I could a tale unfold!"

Why is the letter K like a pig's tail? Because it's at the end of pork.

Why are hogs more intelligent than humans? Because they nose (knows) everything.

How do you spell "blind pig" in two letters? P G—pig without an I.

Why is a hog in a parlor like a house on fire? Because they both want puttin' out.

Why is a magnificent house like a book of anecdotes? It has generally some good stories in it.

What prevents a running river running right away? Why, it's tied up.

What river is ever without a beginning and ending? S-ever-n.

A PROBLEM IN DIAMONDS AND RUBIES.

By SAM LOYD.

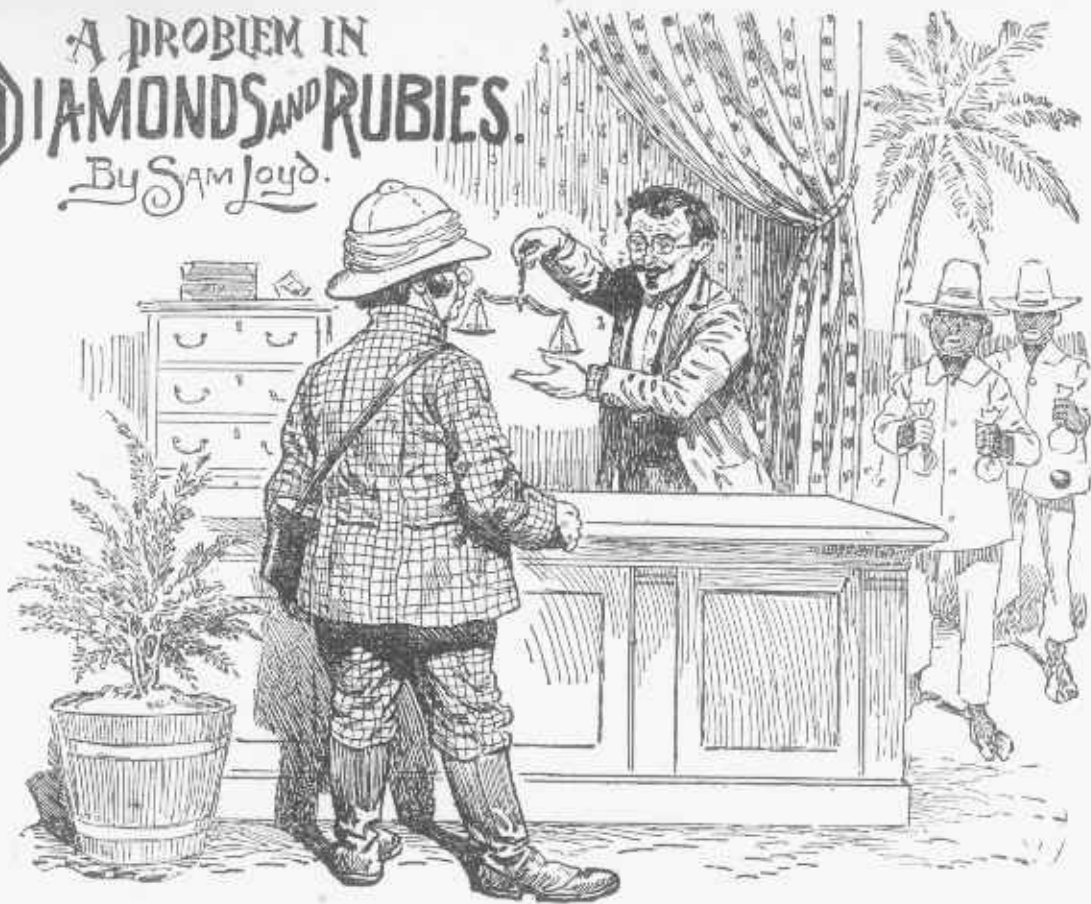

PROPOSITION—Guess the size of the two stones of different sizes which he exchanged for a pair of ear rings of a uniform size.

IT IS WORTH KNOWING that the value of diamonds increases in worth according to the squares of their weight, while rubies increase according to the cubes of their weights, viz., if a fine diamond of one karat is worth \$100, a two-karat stone of the same quality would be worth \$400, while a three-karat gem of equal purity would be worth \$900. If a fine Oriental ruby of one karat is worth \$200, a two-karat stone would be worth \$1,600. It is well to remember that we are discussing gems of equal purity and brilliancy, for the size of a stone is not so important as the quality. A one-karat stone is often more valuable than others of two and three times the size, so that only an expert in the matter of color and purity can give even an approximate value, despite the marvelous accuracy of the scales employed by the trades. A noted merchant, who is familiar with the diamond mines of Brazil, Cape Colony and other quarters of the globe, showed me a pair of earrings

which he had exchanged for two stones of different sizes.

Upon the basis of a single karat being worth \$100, as explained, who can guess the size of the two stones of different sizes which he exchanged for a pair of ear rings of a uniform size. Of course there are many answers to the puzzle so you are asked to find the smallest possible size of two stones which represent the value of two of different sizes without employing fractions of a karat.

Why is a younger brother like a fair complexion? Because he is injured by the sun and heir.

Why is a tradesman like a divinity student? Because he studies the prophets.

What of all things in the world is the longest—and the shortest; the swiftest and the slowest; the most divisible and the most extended; the most neglected and the most regretted; without which nothing can be done; which devours all however little, and ennobles all that is great? Time.

Why is magnetism like the police when most needed? Because it is an invisible force.

When is a square field not a square field? When it is a rye field.

Why is a fish hook like the letter F? It makes an eel feel.

What is invisible but never out of sight? The letter I.

When is a boat like a knife? When it is a cutter.

What part of London is in France? The Letter N.

Why is a rosebud like a promissory note? It matures by falling due.

What two reasons might be given to prove that a bride is erring? She is mistaken and miss-led.

What is the best key to a good dinner? A turkey.

When is a pig's tail like a carving-knife? When it is flourished over a ham.

Why does it fatten a child to drop it? Because it comes down plump.

How did a blind man pour out his tea? He took a cup and saw sir.

The Tinker's Puzzle

—BY—
SAM LOYD



PROPOSITION—Tell the size of the kettle.

ATERING TO THE mathematical bent of the many who revel in geometrical problems and abstruse calculations I shall take occasion to call attention to that jingling bit of Mother Goose which appears to contain a somewhat pretty problem.

The old song says:
"I agreed with a tinker whose name was Doo-little

To make for my aunt a flat-bottomed kettle.

Twelve inches exactly the depth of the same,

And twenty-five gallons of beer to contain.

The inches across at the top would show

Just twice the width, as measured below.

So tell me that width, across at the top,

For auntie now wants a lid from the shop."

There is nothing required to be added to the above data, so we will just see how many of our mathematicians can give us the diameter of

the required lid to fit on the kettle, which is twelve inches deep, and will hold just twenty-five gallons.

Why is a railroad track a particularly sentimental object? Because it is bound by close ties.

What is society composed of? A mixture of mister-ies and miss-eries.

What is taken from you before you get it? Your portrait.

When is a man's friendship most severely tried? When he stands a loan.

What melancholy fact is there about a calendar? There is no time when its days are not numbered.

What is the best food for dyspeptic people? Oysters; because they die-just (digest) before they are eaten.

Why is a distanced horse like a man in a shady place? Because he is out of the heat.

Do you know what is the oldest piece of furniture in the world? The multiplication table.

Why is a kiss like a rumor? Because it goes from mouth to mouth-

When are soldiers best able to draw blisters? When they are mustered in the service.

Why is the woodsman's ax an inconsistent weapon? Because it cuts a tree down and then cuts it up.

Why is an inn-keeper like a multitude of people? Because he is a host himself.

Why is the blush of modesty like a little girl? Because it becomes a woman.

Why is a bad epigram like a useless pencil? Because it has no point.

If you see a counterfeit coin on the street why should you always pick it up? Because you may be arrested for passing it.

What key opens the door to the penitentiary? Whis-key.

Why is a pig with a curly continuation like the ghost of Hamlet's father? Because he could a tail unfold.

Why is a plowed field like feathered game? Because it's part-ridges.

How would you make a tall man short? Borrow money of him.

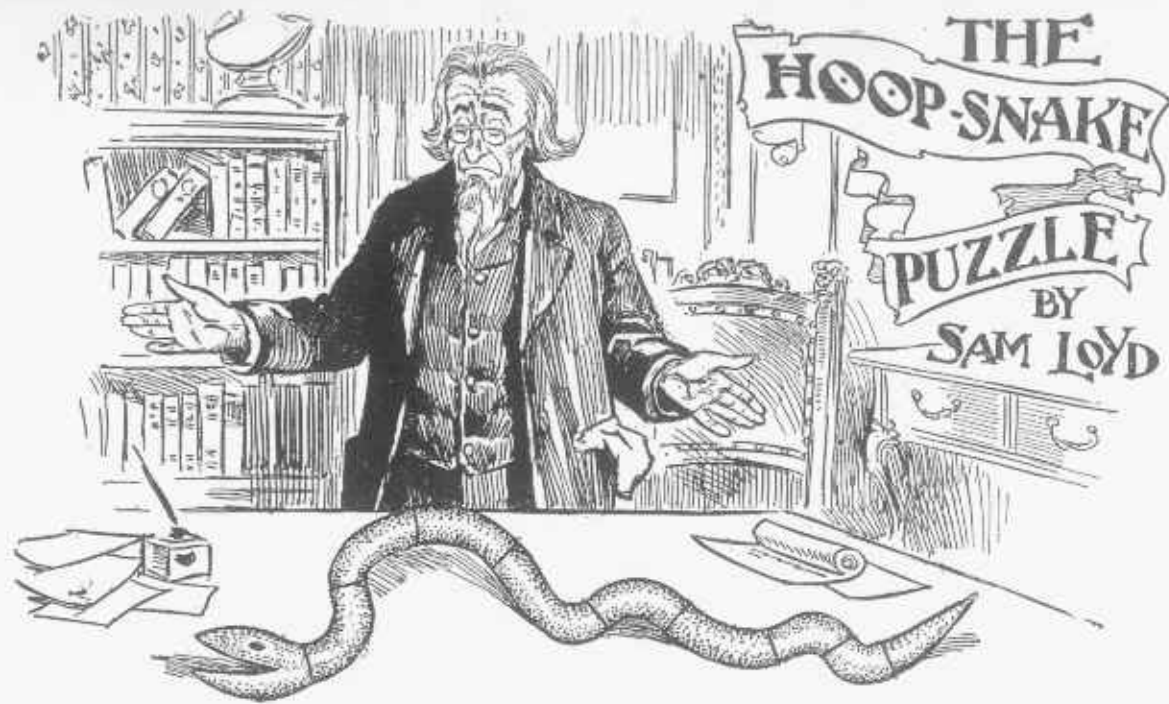

PROPOSITION—Arrange the ten pieces so that the snake will have its tail in its mouth.

THERE IS AN OPPORTUNITY for our young puzzlists not only to combine instruction with amusement, but to aid the cause of science. If it were not of serious importance it might be likened to the case which not infrequently happens to puzzlists when they forget the answer to a puzzle they are showing.

Professor Von Schafskopfen, the distinguished naturalist, has been greatly exercised by the conflicting stories concerning the Hoop Snake, which is so called on account of its peculiar mode of locomotion, produced by taking the end of its tail in its mouth and rolling along the ground like a hoop. This trait of the genus ophidia is described by many naturalists, but considerable discussion has been caused by the account given by a college professor who claimed to have seen three snakes, combined in one large hoop, rolling along at lightning speed, and then suddenly disappear by swallowing each other. No one questions the possibility of the swallowing trick, but grave doubts having been thrown upon the existence of the hoop snake. Professor Von Schafskopfen has been scouring the country in search of specimens. His labors were so far crowned with success as to discover in the wilds of the Hoop Mountains a fine specimen of a petrified hoop snake, in such a

position, with its tail in its mouth, as to prove the truth of the custom. With a fine saw he cut the snake into ten pieces, and, packing them in cotton, returned in triumph with his prize; but has been completely baffled in his attempts to readjust the pieces so as to make both ends meet, and craves your kindly assistance.

Mathematicians say that they can be arranged so as to make 362,882 different snakes, without producing an endless hoop, which the skeptics claim goes to prove that it is 362,882 to 1 that no such snake ever existed.

In his despair the professor asks our puzzlists to submit sketches of the restored Hoop Snake. Puzzles of this nature are offered more in the nature of lessons in puzzle making, for our young folks do not wish to cut up these puzzle pictures. The suggestion is that you might build puzzles upon similar lines.

In law courts what relation are the judges, sergeants and counsellors to each other? They are brothers—brothers-in-law.

Why was St. Paul like a white horse? Because he loves Timothy.

Why do men go out of the theatre? Because some plays are so solemn they must go out to smile.

What is the color of a grass plot covered with snow? Invisible green.

Why don't foreign noblemen marry poor American girls? A poor girl has no principal, hence no interest, and without either she cannot bank account (a count).

What did the blind man say to the policeman when he told him he would arrest him if he did not move on? I'd just like to see you.

If Dick's father be John's son, what relation is Dick to John? His grandson.

When is a silver cup most likely to run? When it's chased.

When may a man's pocket most likely to be empty and yet have something in it? When it has a hole in it.

Why are two t's like hops? Because they make beer better.

Who are the two largest ladies in the United States? Missouri and Mrs. Sippi (Missouri and Mississippi).

When is butter like Irish children? When it is made into little pats.

What are the most difficult ships to conquer? Hard-ships.

When are weeds not weeds? When they become widows.

What is better than presence of mind in a railroad accident? Absence of body.

What letter in the alphabet is most useful to a deaf old woman? The letter A, because it makes her hear.

What subject is generally made light of? Gas.

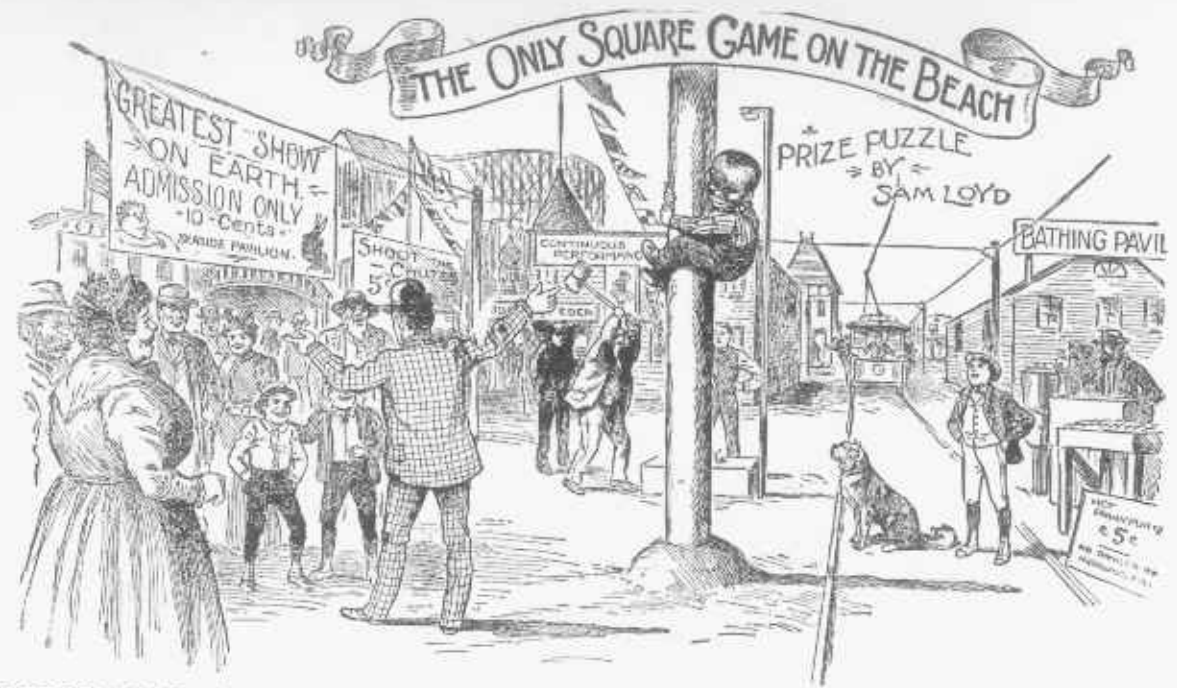

PROPOSITION—Guess the height of that pole!

THERE IS A SEASONABLE little puzzle picked up by the sea, which to a certain extent meets the demands of some of the younger puzzlists, who have at times suggested the presenting of a puzzle which might be solved by a guess "pure and simple," and which would give the veriest little tot as good a chance to win the prize as a big-headed mathematician. To make a slight digression, however, I may say incidentally that my experience has shown that the bright little puzzlists, as a matter of actual fact, get more than their share of prizes, and exhibit surprising natural wit in getting at the true inwardness of a puzzle by quick intuition.

Nevertheless, be that as it may, here is the problem as picked up on the beach. You see, it was the opening of the season last week down at Coney Island, and, as a matter of course, all society had to be there, and I went along with the "push." We had shot all the chutes, tested our strength and lungs on all the machines, and knew just how many times we could hit the darkey's head with a base ball, when we were attracted by the liberal offer of a ten-dollar bill to the one who could climb to the top of a greased pole in the fewest number of minutes. I did not compete for the prize, and am not represented part way up to the pole with that far-away, wearied look, but

that little darkey did get to the top and furnished the subject for the present puzzle. I timed him during his performance of the feat, and obtained the following data for the problem:

THE PUZZLE.

He would climb up six feet in six minutes and then slip back three while resting, and kept right on working at that rate, going up six and falling back three, until he reached the top.

Of course, as the problem is to tell how long it took him to reach the top, our puzzlists would like to know the height of the pole, so I took a snap-shot photograph of the scene, just as he was taking a rest, and so everything is true to nature and may be depended upon just as well as if you were there.

Boys can doubtless base their calculations upon practical experience, but I think the girls are more lucky at guessing and will stand just as good a chance to win the prizes offered for the best solutions first received, for the guess as to how long it took that little darkey to climb to the top of the pole giving the best reason for the opinion offered.

Of course, this is a puzzle based upon actual facts, as most puzzles are, and it would be a simple matter for any one to run down there and measure the height of the pole, but, strange to relate, this little problem was hatched out upon the very day of the great fire, and in giving the

puzzle I present the last picture taken of the famous old Bowery at Coney Island.

There is really nothing difficult about the puzzle, for if you have your wits about you it is a simple matter to guess the height of the pole.

When is a trunk like two letters of the alphabet? When it is M T (empty).

Why is a waiter like a race-horse? Because he runs for cups and plates, as well as steaks (stakes).

What sort of a day would be a good one to run for a cup? A muggy one.

Why are sticks of candy like race-horses? Because the more you lick them the faster they go.

Why ought a greedy man to wear a plaid waistcoat? To keep a check on his stomach.

Why are free sittings in church very immoral? Because you are getting good—for nothing.

When is a bedstead not a bedstead? When it's a little buggy.

Why, when you are going out of town, does a railroad conductor cut a hole in your ticket? To let you pass through.

What is the greatest instance on record of the power of the magnet? A young lady, who drew a gentleman thirteen miles and a half every Sunday of his life.

When are handcuffs like grip sacks? When made for two-wrists (tourists).

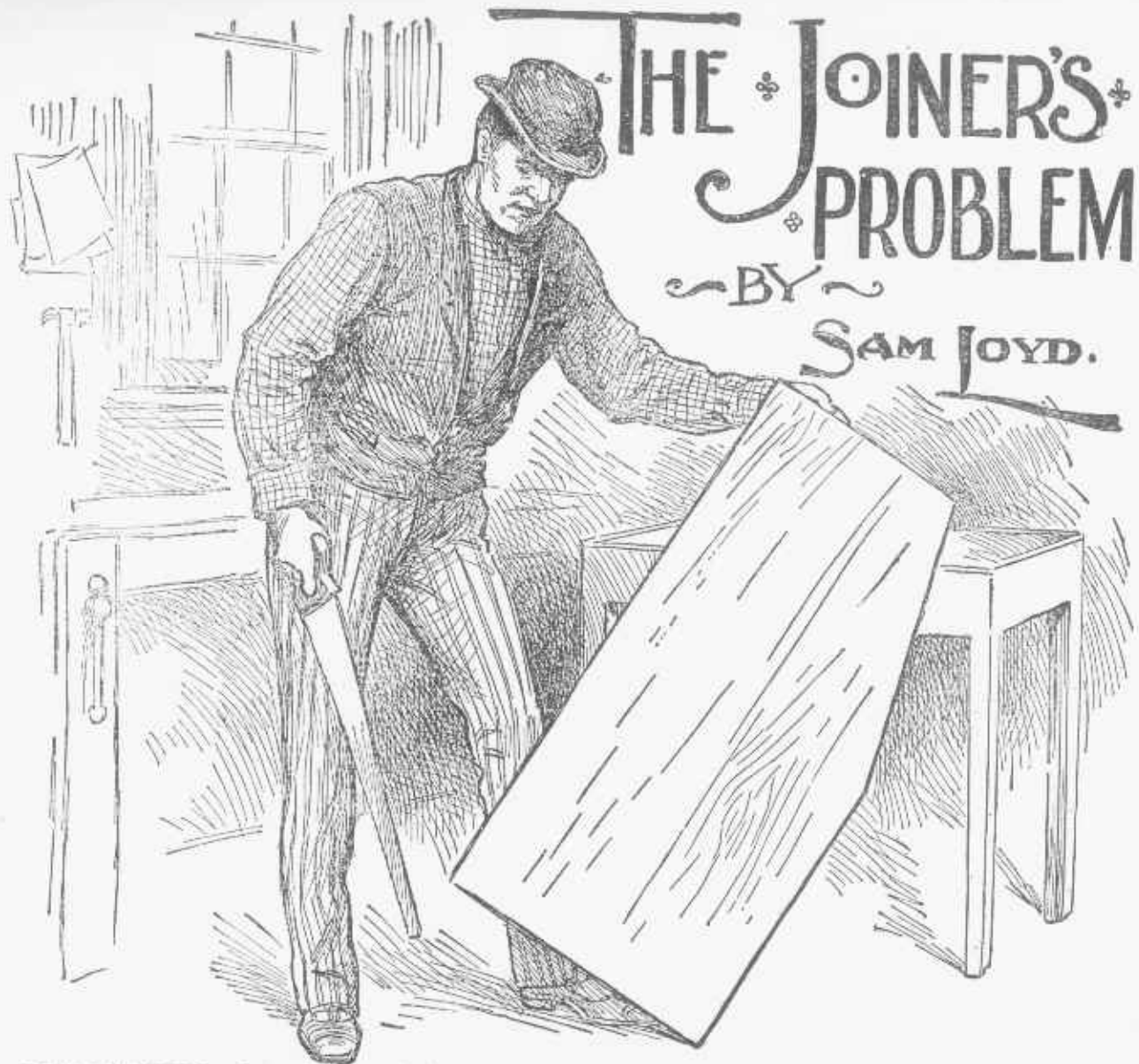

THE JOINER'S PROBLEM

BY SAM JOYD.

PROPOSITION—Cut the board into the fewest possible number of pieces which will fit together and form a perfect square.

STUDENTS OF GEOMETRY will find here an interesting elementary problem which can best be solved by experimental puzzle methods, although it will be found that there is a scientific rule for getting the correct answer which bears a close resemblance to the famous Forty-seventh proposition of Euclid. The joiner has a piece of board four feet long by two feet wide, with a corner clipped off. The puzzle is to divide the board into the fewest number of pieces, so that without any waste they will fit together and make a perfect square top for the table, which is shown in the picture. In this particular case the missing piece

has been cut off at what the mathematicians would term an angle of fifteen degrees, but when you have discovered the answer to the puzzle, it is worthy of note that the rule which governs the same might be applied to any other angle to produce the same result.

A CHARADE.

If from your shelf you take a book,
You'll find me there if you but look;
And if you put me back again,
That I am there is also plain;
Decapitate, 'twill then appear
Without mistake that I am here;
Behold again—you'll want no more,
Because I always come before.
Ans. 20, 8, 5, 18, 5.

A REBUS.

With pen in hand, it may be said
My first you often need;
Then add to that a horse's head,
And what will urge his speed!
Nine letters thus complete my theme,
Which now you bring to view;
And, though it very strange may seem,
I but consist of two!
Cypher Ans. 4, 9, 16, 8, 20, 3, 15, 14, 7.

Why is a horse one of the most worried of animals? His thoughts are always on the rack.

What is the difference between a church organist and the influenza? One knows the stops and the other stops the nose.

The Old Gag Revived

Puzzle by SAM JOYD

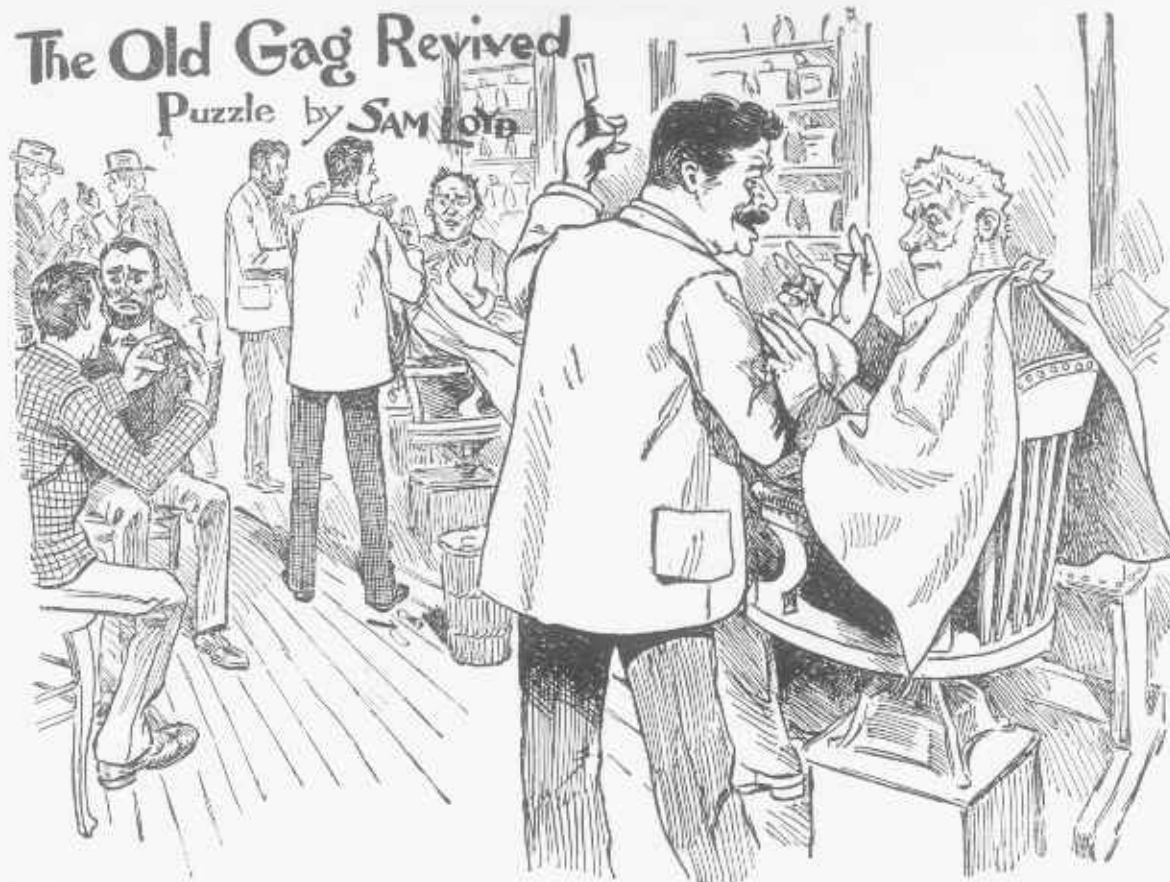

PROPOSITION—How long should it take to eat ten dozen eggs?



ONE OF OUR GREAT office buildings was thrown into a state of utter demoralization the other day by a stupid mathematical chestnut which has been going the rounds for nearly a century. It was the old gag of the apple woman who sold thirty apples at the rate of three for a cent, while another sold thirty apples at the rate of two for a cent, so the first received ten cents and the other got 15 cents, making 25 cents in all. The next day they formed a little apple trust and combined to sell five for 2 cents, but at the close of business found that the sales only netted 24 cents, so each one accused the other of having purloined the missing penny.

In the present instance eggs are substituted for apples, which some people consider a sufficient change to entitle them to the credit of having originated a new puzzle. Dutch Frank, generally known as the "calculating barber," sprung it upon a life insurance agent, who, considering himself away up in figures, would not yield the point without dragging every one who was in the shop into the discussion, so, before

long the business was at a standstill and the argument spread through the entire building as well as adjoining neighborhood. Frank claims that there are two sides to the question, and that barbers, lawyers, doctors and clergymen take one view of the subject, while business men and those who sell things take the other. He even says that from their answers to the puzzle he can tell a professional man from a merchant. Let us look at the puzzle so as to see what it really amounts to.

During an Easter banquet, when ten dozen eggs were consumed without intermission, thirty eggs were eaten during the first course at a rate of three eggs per minute, which would take just ten minutes. During the second course thirty were eaten at the rate of two per minute, which would be fifteen minutes more. Then, finally, in the third course, the remaining sixty eggs were eaten, first three and then two in a minute, alternately, so as to again average five eggs in two minutes.

"Not to bother your head with the mathematics of the situation," says Dutch Frank, "I will just ask you to tell me how long would it

have taken to eat those ten dozen eggs if there had been but half as many guests at the banquet?"

What is the difference between a woman and an umbrella? You can shut an umbrella up.

Why would it be very appropriate for a man named Benjamin to marry a girl named Annie? Because he would be Bennie fitted and she Annie-mated.

When is a horse like a house? When he has blinds on.

Why is modesty the strongest characteristic of a watch? Because it always keeps its hands before its face, and runs down its own works.

Why is it dangerous to keep a clock at the head of a pair of stairs? Because it sometimes runs down and strikes one.

Why are mortgages like burglars? Because they secure your money.

When were there only two vowels? In the days of No-a, before U and I were born?

What, as milliners' say, is "the sweetest thing in bonnets?" A lady's two lips.

What question is that to which you must always answer "yes?" What does y-e-s spell?

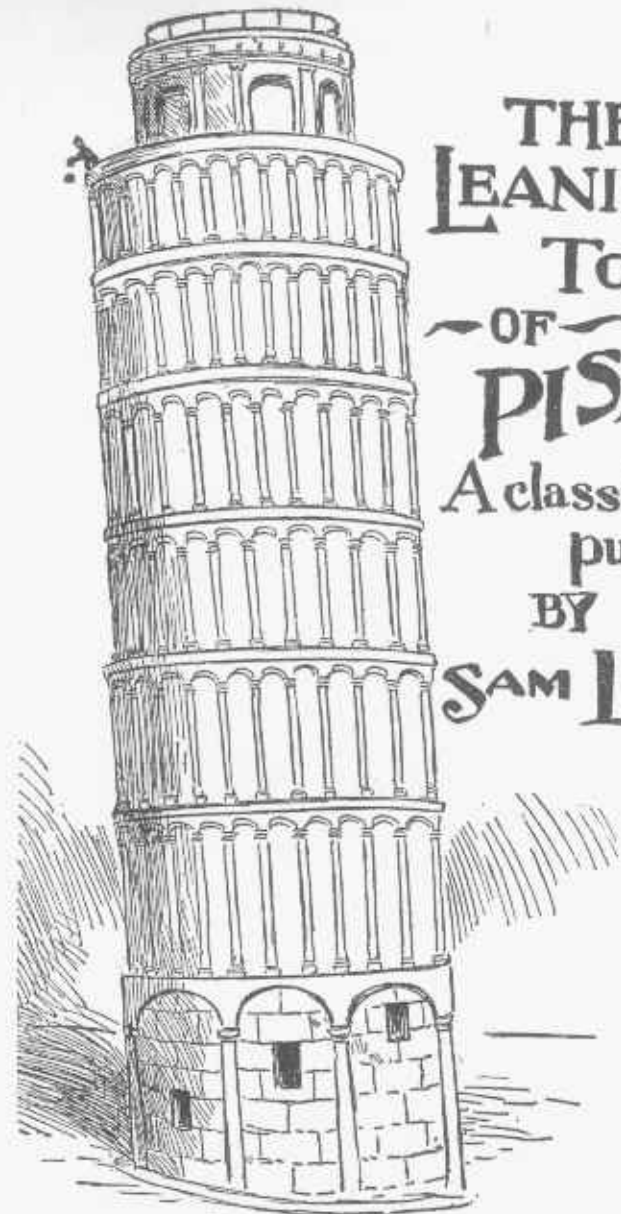

**THE
LEANING
TOWER
OF
PISA**
A classical
puzzle
BY
SAM LOYD.

PROPOSITION—Tell how often the ball will rebound.

THE OLD DISCUSSION is being revived again regarding the accidental or intentional incline of the leaning tower of Pisa. By scientists and mathematicians the story is accepted of its having been built during the twelfth century for the scientific demonstration of certain problems pertaining to the attraction of gravitation, but others maintain that its leaning position was owing to the foundation giving way during its construction. I note that Shepp gives a fine view of it in his photographs of the world, accompanied by the assertion that "it is fifty feet in diameter and leans thirteen feet from perpendicular. The foundation being made insuffi-

ciently solid, it began to incline before it was one-third completed." All of which conflicts with the information of the glib attendant who escorted us to the top, as well as being contrary to common sense. It is difficult to explain why the architect was so fool-hardy as to add the other two-thirds to its height when the foundation was already giving way. It is well known that Galileo's writings tend to show that the tower was built for scientific purposes, and it was there that he refuted the philosophy of his opponents, who maintained that the velocity of a falling body was in proportion to its weight. One of the earlier problems, however, which has been connected

with the purposes for which the tower was erected, was the following the answer to which I do not find in mathematical works.

An elastic ball was dropped from the top of the tower, which is exactly 179 feet high, and on each rebound would rise exactly one-tenth of the height from which it fell. The question was to determine the distance the ball would travel before it came to rest.

A REBUS.

So vast my amount, fills the mind
with dismay!
Behold me, and thus take a thousand
away;
Reverse what remains, and, I'll
daily dispense
To thousands, the gift of a kind
Providence

Why is an opera singer like a confectioner? Because she deals in high screams (ice creams).

A feeling all persons detest,
Altho' 'tis by every one felt,
By two letters fully express'd,
By twice two invariably spelt,
Ervy (N. V.).

Why is education like a tailor? Because it forms our habits.

Why is a robbieman like a book? Because he has a title and several pages.

Why are the legs of an ill-bred fellow like an organ grinder? Because they carry a monkey about the streets.

Why is a blacksmith like a safe steed? Because one is a horse-shoer and the other is a sure horse.

Why is a pawnbroker like a drunkard? Because he takes the pledge but cannot always keep it.

Why are photographers the most uncivil of all trades-men? Because when we make application for our photographs they begin with a negative.

Where does charity begin? At C (Sea).

Which is the strongest day in the week? Sunday, because all the rest are week-days.

When is an altered dress like a secret? When it's let out.

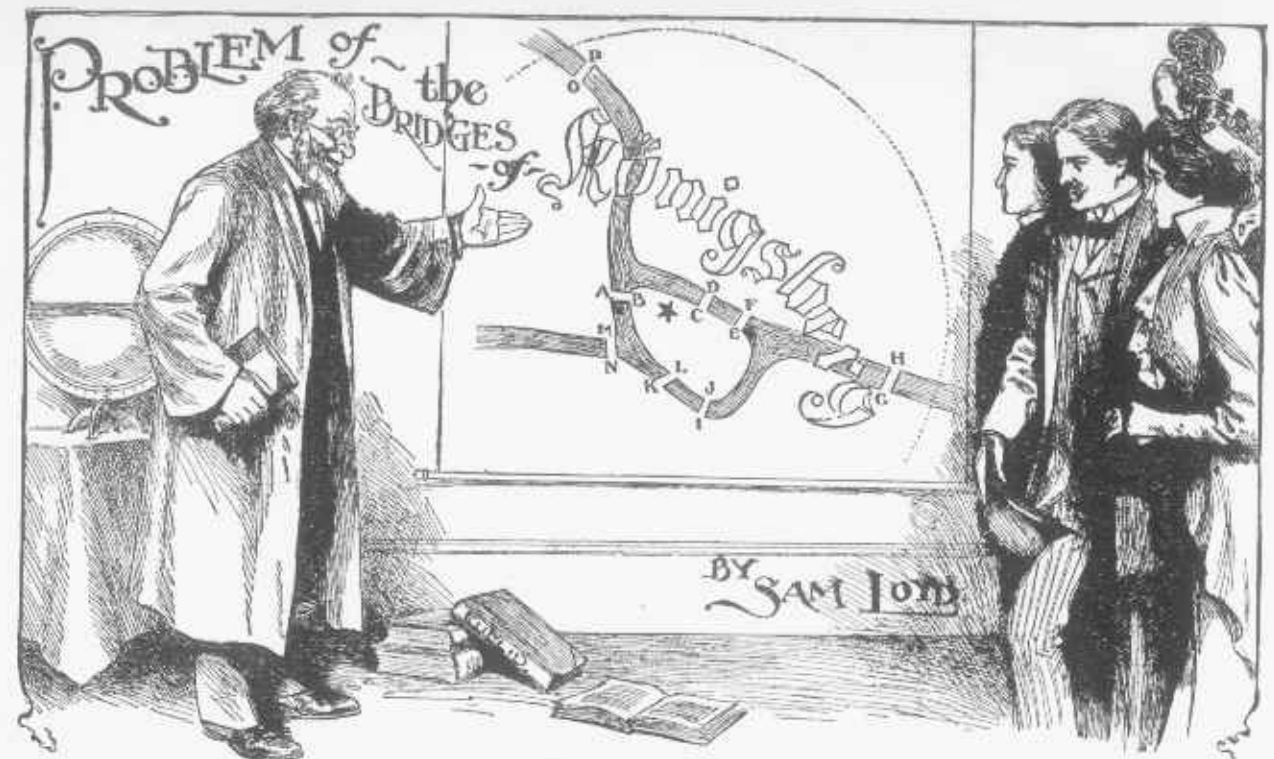

PROPOSITION—Tell just how many different routes there are, and which is the shortest.

THERE IS AN ODD PUZZLE, interesting not only on account of the general principle involved, but because of its antiquity and the curious history connected with it. Königsberg, the second capital of Prussia, is divided by the River Pregel into four quarters, including the island of Kneiphof, as shown in the accompanying map. There are eight bridges connecting the different parts of the town, and there is a puzzle connected with them which greatly vexed the good citizens of Königsberg, over two hundred years ago.

A promenade, embracing a tour of the bridges, had always been an amusement and recreation for the young people, when according to old accounts, somehow or other the question was raised as to how long it would take to make a tour of the bridges, which led to the startling assertion that a complete tour of all bridges—without going over any bridge more than once—was impractical. It is a matter of history that a committee of young folks visited Euler, the mathematician, in 1735, and asked him to decide the point at issue. A year later Euler presented a voluminous report to the Academy of Sciences of St. Petersburg, wherein he claims

to have demonstrated the impossibility of solving the problem. This decision appears in the report of the Academy, 1741, vol. 8, and has been published in French and English by noted mathematicians, as it treats of the principle as applied to any number of bridges. Professor Ball, of Trinity College, discusses the antiquity and merits of the problem in his great work, *Mathematical Recreations*, but errs in ascribing its origin to Euler in 1736, and makes the remarkable statement that "in 1759 there were, and still are, according to Baedeker but seven bridges." The oldest records refer to eight, and our map presents an accurate tracing from Baedeker, who especially refers to the eight bridges. Euler it may be said, was a very young man in 1735, and was not the famous mathematician until nearly fifty years afterwards, so he may have fallen into the error of starting from some of the locations, which, like certain combinations of my 14-15 puzzle, would not work out.

The question of returning to the starting point does not enter into the problem at all; it is merely a matter of proving that it is possible to start from a certain point of the town and go to another point by passing over all of the bridges but once. Then tell just how many

different routes there are, and which is the shortest.

A CHARADE.

Of my first you have two, but here one may do,
To explain it; more need not be spoken;
In my next, deep in shade, some scores have been laid,
And when in my whole, you'r not joking!
Cypher Ans. 5, 1, 18, 14, 5, 19, 20.

A REBUS.

My first is a sign of pain,
Of sorrow or surprise;
My second it is plain
Within your kitchen lies.
My whole is found in Spain,
'Neath genial southern skies,
A fruit,—but I'll refrain,
And leave it in disguise.
Ans. 15, 18, 1, 14, 7, 5.

Why, when you contemplate a trip into the country, should you leave the wash-hand basins behind? Because they are not ewers (yours)! What is the greatest instance of cannibalism on record? When a rash man ate a rasher.

Why can't you make a venison pasty of buck venison? Because the pasty must be made of dough (doe).



"1780"

"Andre's denials fell on deaf ears as his captor's spoke no english."

HERE IS AN ODD little concealed word puzzle, built upon historical lines. According to a German writer upon the American war of independence, the capture of Andre in 1780 was effected by two Hessians, who could not speak English. Without discussing the probabilities of the case, we will ask our young puzzlists to discover the possible home of the captors concealed in the description of the picture.

The General Store Puzzle.

Some people can never catch on to the puzzling features of Algebra, and I confess to the seeming absurdity of multiplying P D Q by m i x, although I can see that the adding of M to ore would make it more. The addition and subtraction of letters is all right, but as a Western school teacher told me, "The multiplication of one letter by another is a corker." He kept a general store in connection with his school "and other things," as he termed it, and,

as shown in the picture, introduced a system of algebra which goes as far as he knew. I saw the billboard, and from the prominent position which he gave to chess, above money consideration and so far away from soap, I knew he must be a true vot-



ary of the royal game, and studied out his algebraical sign.

I soon discovered that, like all great merchants, he had a secret price code, viz.: a word of ten letters which gives a number for each letter, by which they mark their goods. You see the letters are all arranged like numbers to be added up by simple addition. If you will guess what that key word is you can change all the words to numbers and you will see why all of those animals and things add up exactly so as to make "all wool" the correct answer. It is a simple puzzle, and as tending to show that algebra is not such a bugbear after all, our young friends are asked to discover the key to the cypher word.

What French word contains every vowel and but one consonant? Oiseau.

What parts of speech are shopkeepers most familiar with? Articles.

When did Ruth treat Boaz badly? When pulled his ears and trod on his corn.

Why is the port of Plymouth like a very wonderful phenomenon in acoustics? Because it includes a part of the sea called the Sound; and that is the only sound that you can see.

Why are young ladies so partial to sunset and twilight? Because they are daughters of Eve?

What kind of robbery may be said to be not dangerous? A safe robbery.

When is a fish-kettle like a city omnibus? When it's blocked-tin (blocked in).



The Red Cross Lassie Puzzle

BY Sam Loyd

PROPOSITION—Divide a Greek Cross into the fewest possible number of pieces which will fit together so as to form two Greek crosses of similar size.

IN THE WHOLE realm of puzzlement, and geometry included, there is nothing so fascinating and eminently scientific as the series of problems pertaining to the form of the Greek cross and its peculiar relations to the square, parallelogram and other symmetrical shapes.

As differing from the well-known mathematical problem of converting the cross into a square by the fewest possible number of cuts, attention is called to the following pretty feat of changing one cross into two.

It appears that one of our wounded boys in blue, who was returning home after being nursed back to life by a faithful Red Cross lassie, begged the red cross from her arm as a keepsake; but she, in true sweetheart style, took her scissors and by a few deft clips, cut the cross into several pieces, which could be fitted together perfectly so as to make two crosses of similar size. It is a simple but beautiful trick, and

the satisfaction of guessing it will be as great as if you should win a prize.

CHARADE.

Don't lose me friends, though day and night
I mock the swiftest bird in flight.
I'm murdered by mankind at large
Reverse me—quickly I discharge.
Transposed, I'm in a bill 'tis clear
Once more an insect will appear.
Cypher Ans. 20, 9, 13, 5.

A REBUS.

My first is possessed by the Queen,
May Providence long smile upon her!
My next at her court may be seen
By those whom she chooses to honor.
My whole, 'tis admitted by all,
kind reader,
In learning and literature stands as a leader.
Cypher Ans. 20, 9, 20, 12, 5, 16, 1, 7, 5.

Why should buying trousers on

credit be considered dishonorable? Because they are breeches of trust.

CHARADE.

A bitter fruit of sin—in deeds accurs'd—
Teeming with ills to man, beho'd my first;
Oft have its victims to my next been driven;
To herd with beasts—from home and kindred riven,
My whole extends his guardian power
O'er cloister'd fane and battled tower.
Cypher Ans. 23, 1, 18, 4, 5, 14.

A REBUS.

My first to my second is like a twin brother;
Each seems but an echo—the one to the other.
My whole may be heard 'mid the wild surging throng,
Or where thee cool rivulet dances along.
Cypher Ans. 13, 21, 18, 13, 21, 18.



FALSE WEIGHTS.

PUZZLE BY SAM LOYD

PROPOSITION—A commission broker, who charges 2 per cent. from the seller and 2 per cent. from the buyer, makes \$25 by cheating in the weight, as he buys with a weight 1 ounce too heavy and sells with one 1 ounce too light. How much does he pay for the goods?

FOUND THAT THE money of the East was coined in variable sizes and weights to facilitate the swindling of travelers, and of itself is too difficult and complex a puzzle for our mathematicians, so in describing the following manner of trading among the Orientals we will simplify matters by talking in dollars and cents. Camels' hair, which enters largely into the manufacture of shawls and expensive rugs, is gathered by what is known as the common people and sold through a commission broker, in small or large lots, to the merchants. To insure impartiality, the broker never buys for himself, but upon receiving an order to buy, finds some one who wishes to sell, and charges 2 per cent. commission to each of them, thereby making 4 per cent. on the transaction. Nevertheless, by juggling with the scales, he always manages to add to his profit by cheating, the more especially if a customer is green enough to place any confidence in his word or pious exclamations.

I take occasion to call attention to a pretty puzzle connected with a transaction which aptly illustrates the simplicity of his methods. Upon receiving a consignment of camel's hair he placed the same upon the short arm of his scales, so as to make the goods weigh one ounce light to the pound, but when he came to sell it he reversed the scales so as to give one ounce to the pound short, and thus made \$25 by cheating.

It appears to be—and as a matter of fact is—a very simple problem, with clear and sufficient data for the purpose. Nevertheless, it will tax the cleverness of an expert bookkeeper to figure out a correct answer to the question as to how much did he pay for the goods?

Why is a young lady's age after she has reached twenty-five like a floral wedding bell? Because it is never told.

When is a door not a door? When it's an egress (a negress).

What is the difference between a hill and a pill? One is hard to

get up, the other is hard to get down.

Why is a lazy dog like a hill? Because he is a slow pup (slope up).

A crown which was the pride of ancient Rome; whichever way it reads, it is the same. Civic.

Why is a young lady like a sheaf of wheat? First she is cradled, then thrashed, and finally she becomes the flour of the family.

Who is it that always has a number of movements on foot for making money? A dancing master.

How can hunters find their game in the woods? By listening to the bark of the trees.

Why does a man think of his mother's slippers when he handles the lines behind a fine, well-matched pair of horses? Because they are such a spanking pair.

Why is a committee of inquiry like a cannon? It makes a report.

What is more wonderful than a horse that can count? A spelling bee.

Why are tallest people the laziest? Because they are always longer in bed than others.



PROPOSITION—Give the best explanation about the relationship to that mysterious nephew.

THERE IS AN ODD little puzzle in relationships which will amuse the young folks. You see, Uncle Reuben came to town to see his sister Mary Ann, and was doing the sights when they came to that imposing looking hotel shown in the sketch, when Reuben says to his sister: "Before we go any farther I should like to stop in

here a minute and inquire about a sick nephew of mine who stays there."

"Well," says Mary Ann, "as I don't happen to have any sick nephew to worry about, I will just trot on home and we will continue our sight seeing this afternoon."

Who can give the best explanation about the relationship to that mysterious nephew?

A REBUS.

My first is the name to an article given,
For ladies and dandies to put on their linen;
It comes from the forest, I've heard people say,
And is made from the skin of an animal gray.
My second is a fruit which we all love to eat,
It grows on the farm, delicious and sweet.
My whole is the same, and often is seen
In the gardens and fields covered with green.
It is very sweet and pleasant to eat,
In the hot summer it makes a rich treat.
Cypher Ans. 13, 21, 19, 11, 13, 5, 12, 15, 14.

CHARADE.

The troop arranged for battle,
Without my first would fly,
And whether good or bad,
Without it you would die.

Go seek the earth and ocean,
For smallest things you guess;
Yes, bring the storm from the air,
And still my second's less.

The traitor, when condemned to die,
May calm his cares and pray;
Yet when the axe sounds "dust to dust,"
My whole he's borne away.
Cypher Ans. 8, 5, 1, 4, 12, 5, 19, 19.

What man had no father? Joshua, the son of Nun.

When is a young man of the greatest use at suppertable? When he's a spoon.

Why does a miller wear a white hat? To keep his head warm.

Part of a foot with judgment transpose,

And the answer you'll find just under your nose.

Inch—chin.

Why is avarice like a bad memory? Because it is always for getting.

Why is it vulgar to play and sing by yourself? Because it is so-lo (so low).

What is that which touches one but unites two? A wedding ring.

Why is it better to be burnt than to have your head cut off? Because a hot steak is better than a cold chop.

Why do girls kiss each other, and men not? Because girls have nothing better to kiss, and men have,

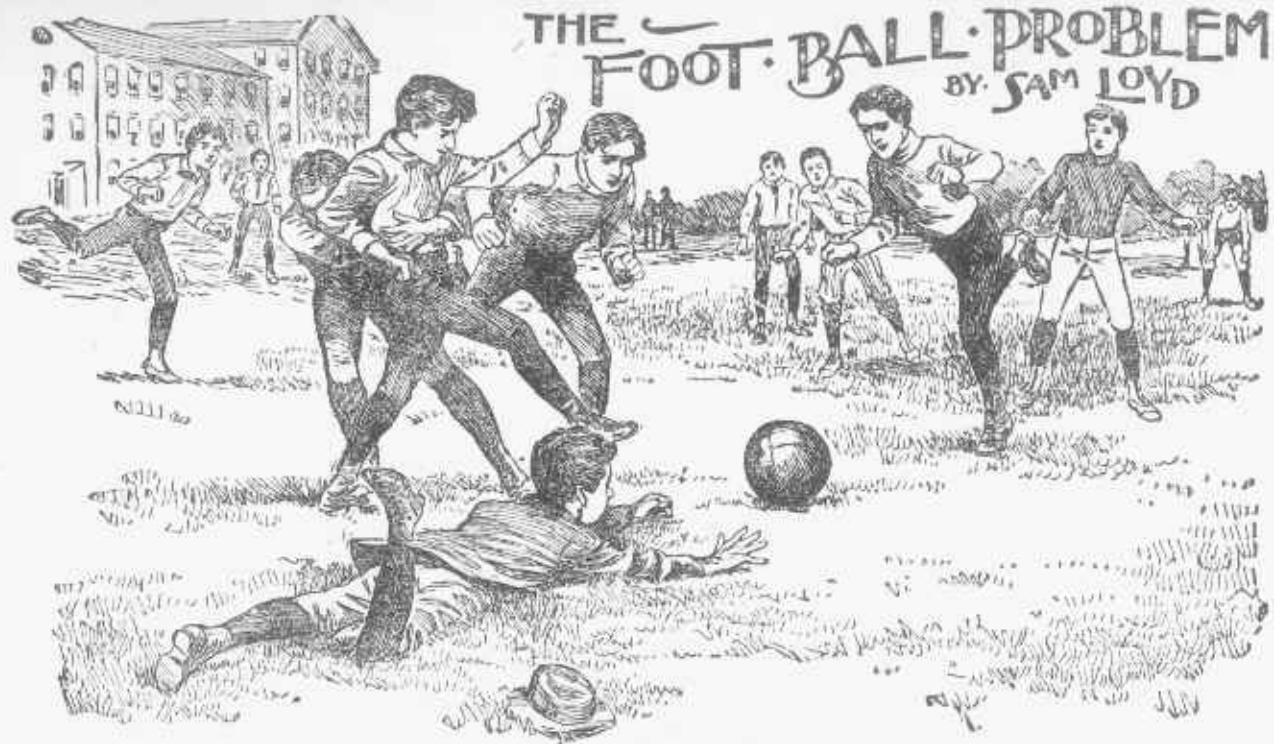

PROPOSITION—What was the size of the foot ball?

F COURSE, FOOT-
ball is now a seasonable
topic, for, as one of the
poets has well said:

When the baseball season's waning
And the heroes of the bat
Are preparing for their exit,
While the rooters sadly chat,
It is then the football kickers,
Who from public view had slid,
Reappear and start their drilling
For their battles on the "grid."

But, as I am not protected with a
patent cast-iron nose, I shall not
jeopardize that organ by sticking it
into a game with which I am not fa-
miliar. Armored ribs and padded
shins were not in vogue in my
student days. We used to play foot
ball with our feet, as the name im-
plies, and never tried to kill or maim
the opposing players, so I am not
up in any of the modern tactics, and
am only induced to attempt a foot-
ball problem at the suggestion of a
surgeon of one of the college teams
who thought it would be a timely
topic.

My puzzle, however, will have
nothing to do with "rushes,"
"punts," "touchdowns," or even high
kicking. It is simply a little remin-
iscence of the days when we country
boys loved to kick the old-fashioned
soft rubber ball about the green.
The problem will turn upon the

amount of rubber and wind that the
old black ball contained.

We lived way back in the country,
and used to order our ball by mail,
according to sizes, as advertised in
a sporting house catalogue, which
advised patrons to "give the exact
number of inches required," and
that is where the problem comes in.

We were told to give the required
size in inches, but as we did not
know whether it meant the number
of inches of rubber on the surface,
or the number of cubic inches of
wind contained in the ball so we
combined the two principles and
ordered a ball which should contain
just as many cubic inches of air as
it had superficial inches of surface!

How many of our puzzlists can
guess the diameter of the ball which
was ordered?

A CHARADE.

The earth, or sky, my first will show,
And 'tis described by men of
science;

My next a home for thousands,
though

Plundered of its stores in defiance.
To find my whole, research must be
Through records of antiquity.
Cypher Ans. 1, 18, 3, 8, 9, 22, 5.

Why does a sick person lose his
sense of touch? Because he don't
feel well.

A CHARADE.

When the tempest roars the loudest,
Oft my first a shelter proves;
Say what fair one, though the proud-
est,

Spurns my next from one she
loves?

When the storms of lives are past,
Few but find my whole at last.
Cypher Ans. 3, 15, 22, 5, 18, 9, 14, 7.

Why is a man hesitating to sign the
pledge like a skeptical Hindo? Be-
cause de hoes not know whether to
give up the jug or not (Jugernaut).

A CHARADE.

Behold my poor first, and it gives
you my second;

My whole is a nourishing beverage
reckoned.

Cypher Ans. 16, 1, 12, 5, 1, 12, 5.

Why is a patch of sweet corn like
a dunce? Because it is liable to
get its ears pulled.

When is a man near selling his
boots? When he has them half-
soled.

Why is an attorney like a min-
ister? Because he studies the law
and profits.

Why is a chicken running like a
man beating his wife? Because it
is a fowl proceeding.

Why are widowers like dilapidat-d
houses? They want repairing.

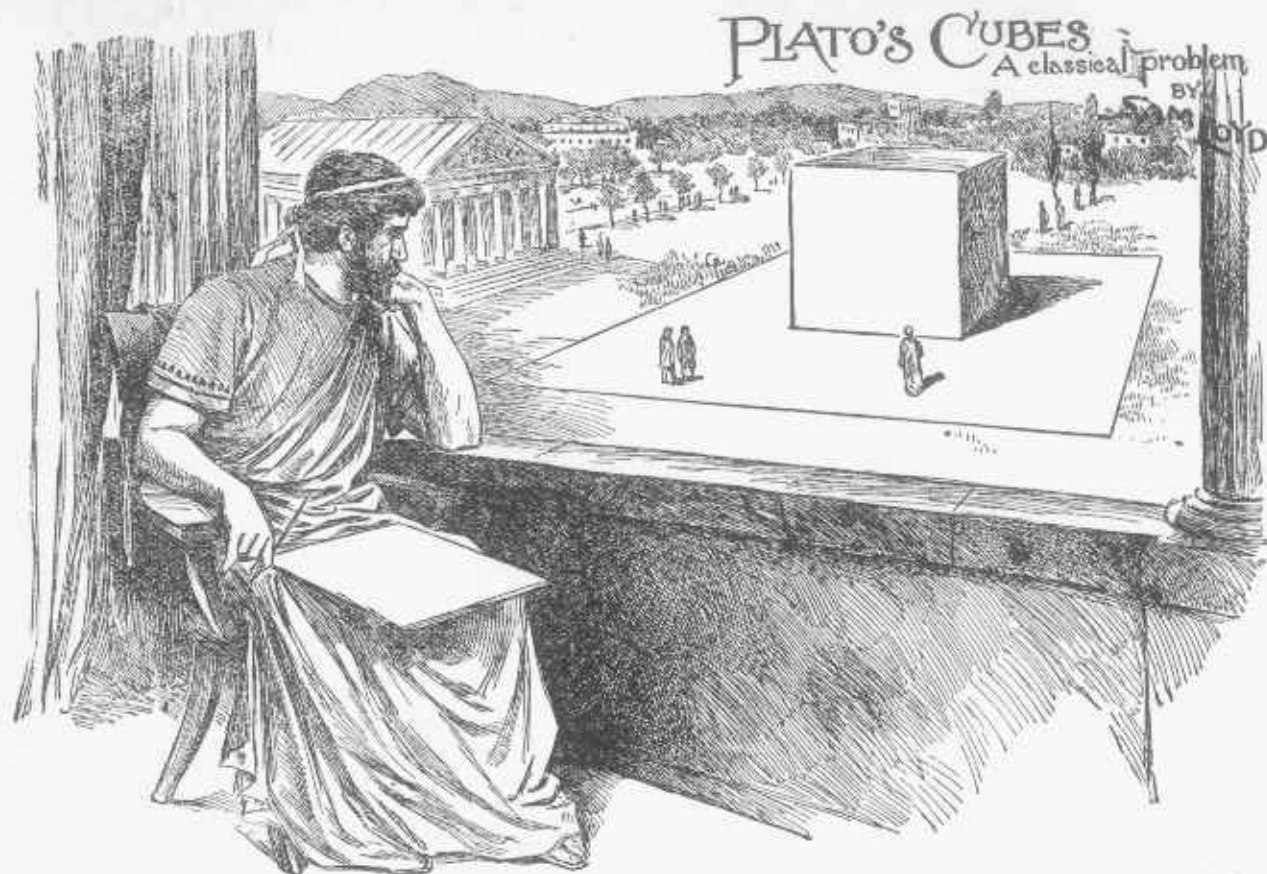

PROPOSITION—Tell how many cubes there are.

RE F E R E N C E I S
often made to the class-
ical legend of the Delian
problem, which involves
the question of the dup-
licating or doubling the area of a
cube. Philiaponus tells how the
Athenians, in 432 B. C., when suffer-
ing from the plague, consulted Plato,
the pupil of Socrates, in regard to it.
They conferred with the oracle at
Delno, and Apollo told them that
they must double the size of the
golden altar of the temple. This
they were unable to do, and Plato,
who was the greatest mathematician
as well as philosopher, of his day,
told them that they were being
punished for their willful neglect of
the sublime science of geometry,
and deplored that they had not one
man among them sufficiently wise
to solve the problem.

The Delian Problem, which is
neither more nor less than the dupli-
cation of the cube, is so generally
confounded with that of Plato's
Cubes that writers who are not up
in mathematical lore get them sadly
mixed. The latter is sometimes re-
ferred to as Plato's Geometrical
Numbers, and is most generally ac-
companied by the statement that

little or nothing is known about the
true conditions of the problem, and
some writers maintain that its terms
are lost.

It is known, however, that there
was a problem referred to by ancient
authors as Plato's Cubes and Geom-
etrical Numbers, and it also is
known that Plato made the science
of mathematics the fundamental
principle of his religious philosophy,
and erected monuments in honor of
the sublime truths, as he termed
them.

One monument has been described
as a massive cube erected in the cen-
ter of a tiled plaza, and it requires
no stretch of imagination to associate
the monument with a problem which
has been spoken of as that of the
geometrical numbers. Everything
is so reasonable and consistent with
the requirements and history of the
problem that there is no reason to
doubt its ancient origin. The sketch
shows Plato gazing upon a marble
monument which is constructed
out of a given number of smaller
cubes. The monument in turn
rests in the center of a square
plaza, paved with cubic blocks of
marble. There are just as many
cubes in the pavement as there are

in the monument, and they are pre-
cisely of the same size, so tell how
many cubes are required to con-
struct the monument and the square
plaza upon which it stands, and you
will have solved the great problem
of Plato's geometrical numbers.

How many peas would you expect
to find in a pint? One (p).

What animals are as bad as Can-
nibals? Ant-eaters.

What was the first bet of which
we have any record? The alpha-
bet.

How would you make a Maltese
Cross? Pull her tail.

What makes the ocean get angry?
Because it is crossed so often.

When is a smith not a smith?
When he's a-filing.

When is a mason a house? When
he's a-building.

Why is an Englishman like nine-
teen shillings? Because he is under
a sovereign.

Why does the schoolmaster enjoy
the summer? Because he keeps his
days cool from nine till three.

What is the difference between a
seamstress and a groom? One mends
the tear and the other tends the
mare.

Well-Recommended

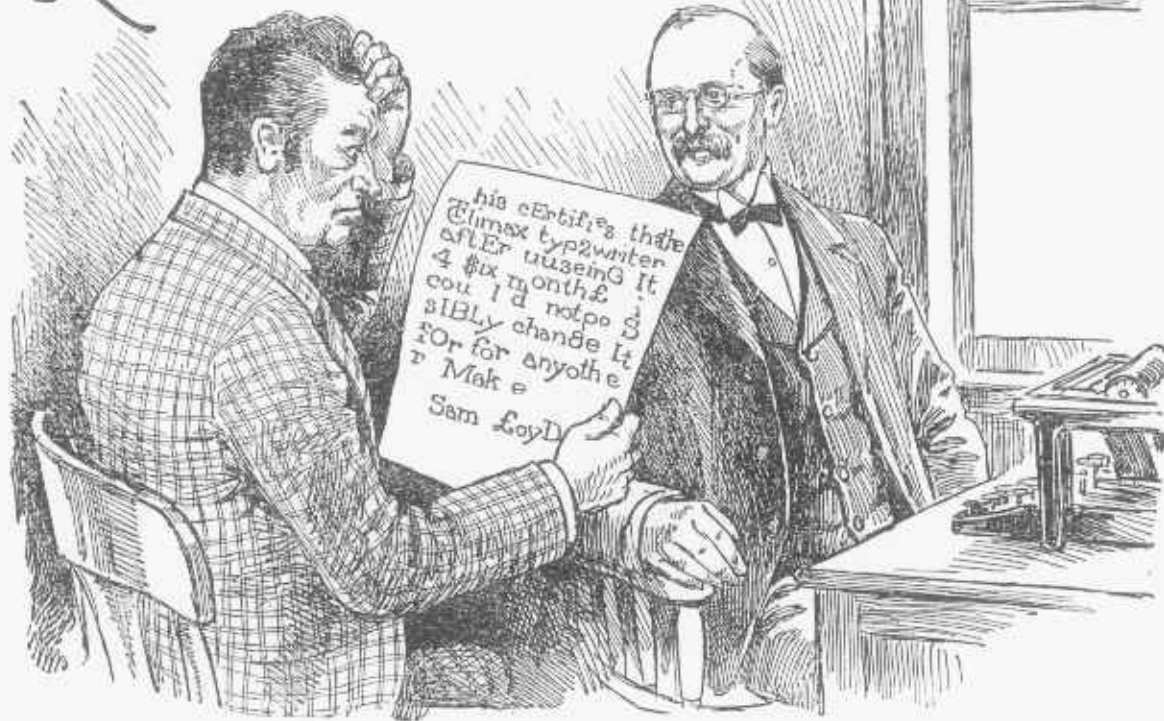

PROPOSITION—Why was this testimonial like the American War of Independence?

TAKE OCCASION TO say that if any of my friends should be urged to invest in a new typewriter through the influence of the recommendation or testimonial I was induced to give, it is to be hoped that, metaphorically speaking, like true puzzlists, they will read between the lines, as it were, and give the due consideration which it merits.

The agent called just to ask how the machine had behaved itself, and when I replied "out of sight," he asked me to give a short testimonial to that effect, which I cheerfully did.

He was a clever fellow, and I liked him immensely, for he said that the testimonial was just like the American war of independence. Ha! Ha! It was such a capital conundrum that I offer to give that typewriter as a prize for the best answer, and in case of there being many, or in fact several hundred correct answers, will be only too glad to divide the machine up into very small pieces and give each one a fragment. It is a somewhat odd

conundrum, which you may not be able to guess, but just send the best answer you can—right or wrong. Conundrums are susceptible of so many different answers that we never know who may chance to send the most clever reply. I remember many years ago at a conundrum party, that some one sprung the old chestnut: "Why are hens immortal?" the reply to which was "Because their sons never set." A bright little miss to whom it was new gave the answer which has been popular ever since: "Because they have their next world in this." (Their necks twirled) which goes to prove that even when you have the best answer there may be a better, like the query as to who was the biggest: Mr. Bigger, Mrs. Bigger or the baby who you all remember was still a little bigger.

Why is it absurd to call a dentist room the dental parlor? Because it is the drawing room.

Why should a man never tell his secrets in a corn-field? Because so many ears are there, and they would be shocked.

What part of a fish weighs most? The scales.

What fruit does a newly married couple resemble? A green pear (pair).

Why is it absurd to ask a pretty girl to be candid? Because she cannot be plain.

Why is a sheep like a professional gambler? Because he is brought up on the turf, gambols in his youth, herds with blacklegs, and is fleeced at last.

Why is a well-trained horse like a benevolent man? Because he stops at the sound of woe.

What city is drawn more frequently than any other? Cork.

Why is bread like the sun? Because it rises from the yeast.

When is a chair like a lady's dress? When its sat-in.

When is a soldier like a watch? When he is on guard.

When does a chair dislike you? When it can't bear you.

Why is a duel quickly managed? Because it takes only two seconds to arrange it.

What burns to keep a secret? Sealing-wax.

THE MONASTERY WINDOW

BY SAM LOYD



PROPOSITION—Can you decypher this precept?

EVERY COLLECTION of tricks and puzzles gives the famous old missing vowel inscription: P R S V R Y P R F C T M N V R K P T H S P R C P T S T N, which is to be found over the entrance to an ancient monastery in England. It is stated that the inscription was originally painted in red and black, and that the red letters, which were all Es, had faded out, which makes it quite an interesting problem to restore the missing vowels. Many years ago I visited the monastery, and after a careful examination of the inscription became satisfied that the same was purposely intended to be in the nature of a secret cipher, especially as several complete books of a religious nature were published with all of the vowels omitted.

To the left of the entrance there is a large memorial window, which is shown as a specimen of early

workmanship in colored glass, but so far as I am aware, no history or explanation regarding it has ever been offered. As fitting, however, to the inscription over the door and in view of their having originally been ten of these windows, I ask our puzzlists to look upon the accompanying illustration of the window in the light of a remarkable charade puzzle, in which one of the "precepts ten" is cleverly concealed.

A REBUS.

Ever running on my race,
Never staying at one place,
Through the world I make my tour.

Everywhere at the same hour.
If you please to spell my name,
Reversed or forward 'tis the same?
Cypher Ans. 14, 15, 15, 14.

Why are the pages of a book like the days of man? Because they are numbered.

A REBUS.

My first might well be called a squeeze.

My next may be defined a nod;
My whole a sham, or cheap alloy
Resembling that for which we plod.

Cypher Ans. 16, 9, 14, 3, 8, 2, 5, 3, 11.

A REBUS.

My first is a part of the day,
My last a conductor of light,
My whole to take measure of time,
Is useful by day and by night.
Hour glass.

I am a word of three letters, signifying to spoil or injure. Reversed I am an animal. Transposed, I am a part of the human frame. Mar, Arm. Ram.

Which is the best sea for a sailor to be in when there is a gale? Adriatic.



PROPOSITION—Decypher the cryptogram.

CONTINUING A former reference to Alice's trip through wonderland, we call attention to her remarkable experiences with the Cheshire cat which had such a way of vanishing away into thin air, so that nothing but its irresistible smile remained. Of course every one remembers the dilemma of the king's executioner, who, being commanded to cut off the head from a cat which had no body, was as sorely puzzled as was the Irishman who was told to decapitate the head of an elephant from the trunk. When Alice first saw her feline friend she desired to find out what species of animal it was, and as they always ask questions in wonderland by writing, she wrote out her query. But as they generally read things backward, or up and down in wonderland, she wrote it as shown in the puzzle. This permits readers to commence and end where they please, just as they should in wonderland; but, as Lewis Carroll forgot to give the answer to his conundrum of why a desk was like a crow, he also forgot

the main question in this riddle, which is simply to tell how many ways there are to read the question: "Was it a cat I saw?"



How Anna polishes the silver when Jack is expected.

CHARADE.

Ye bards, perhaps my first may do
Ere you begin to sing;
My second oft salutes the ear
When horrid wars begin.
My whole denotes a stupid elf,
So find this out to clear yourself.
Cypher Ans. 8, 21, 13, 4, 18, 21, 15.

My first is French, my second is English and my whole is Latin? Latin!

What would give a blind man the greatest delight? Light.

HOW WE KNEW.

I will ask the assistance of the class in concealed geography in unraveling a mystery which perplexed me not a little bit during a visit to a friend's house, where I expected to meet Jack, a young man of my acquaintance. The youngster of the family, a bright little lad of 7 years, will become a great puzzlist or politician if he is not killed off young. He "guessed" Jack would be there "all right, all right," he said, "because why he could always tell almost when Jack would be to supper by the way sister Anna polished the silver."

For the life of me I could not see through that puzzle, but somehow or other "the boy guessed right the very first time," for Jack was there "all right, all right," so I made a sketch of it, and will ask our juvenile puzzlists to discover if the description of the picture gives any clue to the locality of the incident.

The Steeplechase Puzzle

—BY—**SAM LOYD.**

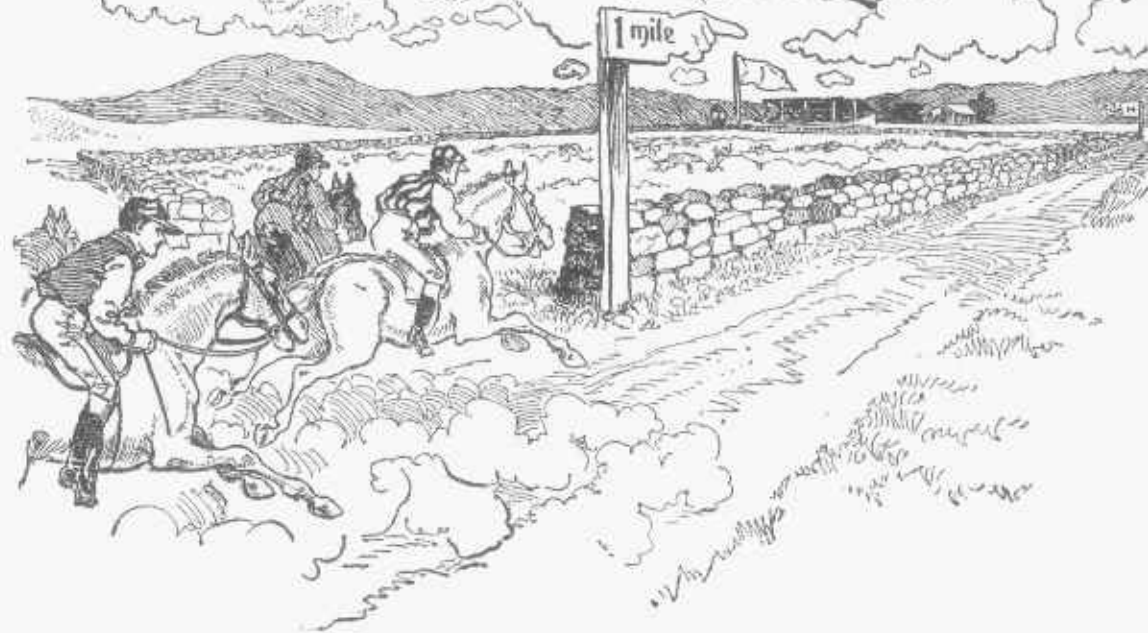

PROPOSITION—Show the shortest route to the home flag.



HERE IS A LITTLE cross-country steeplechase problem which developed during the recent meeting, which will interest turfites as well as puzzlists. It appears that toward the end of a well-contested course, when there was but a mile and a quarter yet to run, the leaders were so closely bunched together that victory turned upon the selection of the best or shortest road. The sketch shows the judges' stand to be at the opposite end of a rectangular field, bounded by a road of a mile long on one side by three-quarters of a mile on the other.

By the road, therefore, it would be a mile and three-quarters, which all of the horses could finish in three minutes. They are at liberty, however, to cut across lots at any point they wish, but over the rough ground they could not go so fast. So while they would lessen the distance, they would lose twenty-five per cent. in speed. By going directly across on the bias, or line of the hypotenuse as the mathematicians would term it, the distance would be a little over a mile and a half. What time can the winner make by selecting the most judicious route?

A CHARADE.

My first without wings is enabled to fly,
It never once tires in the midst of its flight,
Piled on it vast masses of luggage still lie,
Which it never sinks under by day or by night.

See fear is upon you, my next is come on;
Yourself pary compose, it is only your nerves
That cause this annoyance; now, now it is gone;
Alas! what a trifle its purposes serve!

My whole is of thousands of mortals the dead;
'Mid stillness engendered, it works in the dark;
O'er its awful effects many tears have been shed,
And wide devastation its ravages mark.
Cypher Ans. 5, 1, 18, 20, 8, 17, 21, 1, 11, 5.

Why are laundresses good navigators? Because they are always crossing the line, and going from pole to pole!

A REBUS.

Beside my first is often made
A bargain good or bad,
Before my next is oft displayed
What may behind be had.
Beneath my whole in fancied bliss,
We care for neither that nor this.
Cypher Ans. 3, 15, 21, 14, 20, 5, 18, 16, 1, 14, 5.

A CHARADE.

Enchain my vile first, for the general weal,
That a nation's sad wounds may have leisure to heal;
Engage my first next, but he springs from his lair,
And give thee for combat, no time to prepare;
Suppress my dire whole, but, before thy shocked gaze,
Each smouldering spark burst out in a blaze.
Cypher Ans. 18, 5, 2, 5, 12, 12, 9, 15, 14.

What is it which if you name it even you break it? Silence!

What is that which you can keep even after giving it to somebody else? Your word.

Why is a washerwoman the most cruel person in the world? Because she wrings men's bosoms.

PUZZLE OF GRAND FATHER'S CLOCK BY SAM LOYD



PROPOSITION—Tell the time by the clock.

BACK OF THE OLD-time song of "Grandfather's clock was too tall for the shelf, so it stood for ninety years on the floor," there was a legend of a pestiferous grand-father and a cantankerous old clock which, from the fitful time when "it was bought on the morn, when the old man was born," it had made his whole life miserable, owing to an incurable habit which the clock had acquired of getting the hands tangled up whenever they attempted to pass.

These semi-occasional stoppages became of more frequent occurrence as advancing age made the old gentleman more irritable and his feeble hands more incapable of correcting the cranky antics of the balky old timepiece.

Once when the hands came together again and stopped the clock,

the old man flew into such an un-governable passion that he fell down in a fit, stone dead, and it was then that

"The clock stopped short,
Never to go again,
When the old man died."

A photograph of the clock was presented to me, showing the classical figure of a female representing time, and it struck me as remarkable that with the knowledge of the hour and minute hands being together that it should be possible to figure out the exact time at which "the old man died," from the position of the second hand as shown, without having to see the face of the clock. The idea of being able to figure out the exact time of day from seeing the second hand alone is very odd, although not so difficult a puzzle as one would imagine.

My second belongs to my first;
but my whole has nothing to do with
either my first or my second. Hogs-head.

HIDDEN CITY.

Speaking about the recent cat show, I wish to mention that Uncle Rubens and wife were on here last week, and being interested in such matters, resolved to see if there were any felines on exhibition to compare with their old family cat. By mistake they got into the zoo, and, as shown in the puzzle sketch, were surprised at what they saw.

How many of our young puzzlists can discover Aunt Betsey's home, concealed in what she says?

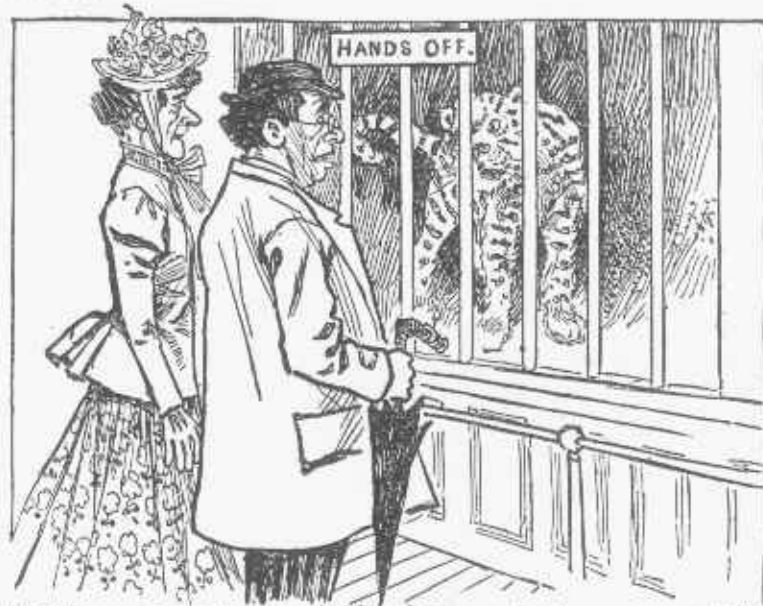

"Rubens just look at that superb Angora cat!"

THE SWITCH PROBLEM BY SAM LOYD

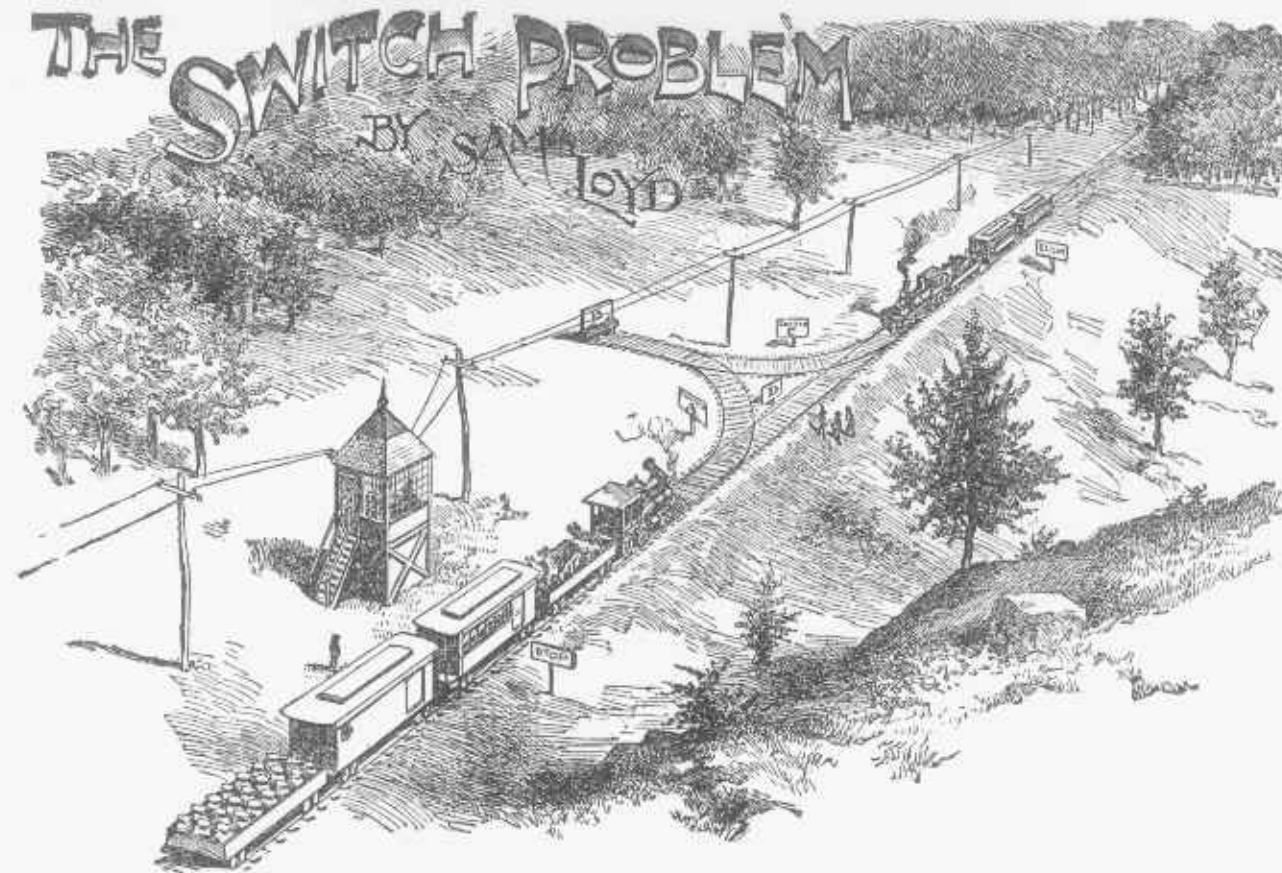

PROPOSITION—Show how to let the two trains pass.

THIS IS A PRACTICAL problem for railroad-men, given to illustrate some of the complications of every-day affairs and is based upon the reminiscences of the days when railroading was in its infancy, before the introduction of double tracks, turn tables or automatic switches. Yet, I am not going back to the days of our great-grandfathers, for there are those among us who are familiar with the advent of the iron horse, and the good lady who furnished me with the subject matter of this puzzle based it upon personal experience of what she called "the other day."

To tell the story in her own way, she said:

"We had just arrived at the switch station, where the trains always pass, when we found that the Limited Express had broken down. I think the conductor man said the smokestack had got hot and collapsed, so there was no draught to pull it off the track."

The picture shows the Limited Express, with its collapsed engine, and the approach of the accommodation train from Wayback, which,

by some means or other, must pass the stalled train.

The problem being to make the two trains pass, it is understood that no ropes, poles, flying switches, etc. are to be employed; it is a switch puzzle pure and simple, the object being to get the accommodation train past the wreck and leave the latter train and each of its cars in the position as shown in the sketch. It is necessary to say that upon the side switch there is but room enough for one car or engine, which is also true of the sections of the switch marked A, B, C or D.

The problem is to tell just how many times the engineer must reverse; that is, change the direction of his engine to perform the feat. Of course the broken-down engine can not be used as a motor, but must be pushed or pulled along just as if it were a car. The cars may be drawn singly or coupled together in any required numbers.

The problem complies with the ordinary rules of practice and is given to test your ingenuity and cleverness in discovering the quickest possible way to pass the broken down train.

What is the difference between a lady and an apple? One you have to get side her to squeeze, and the other you have to squeeze to get cider.

Who is the greatest chicken-killer spoken of in Shakespeare? Macbeth, because he did murder most foul.

Why is music cheaper on Sunday than during the week? Because during the week you get it by piece, and on Sunday you get it by the choir.

Which death would you prefer to die, Joan of Arc's or Mary Stuart's? Most people prefer Joan of Arc's, because they like a hot steak better than a cold chop.

If you were invited out to dinner and on sitting down to the table saw nothing but a beet, what would you say? That beet's all.

When is charity like a top? When it begins to hum.

Why is a man sometimes like dough? Not because a woman needs (kneads) him, but because he is hard to get off of her hands.

Why are a dead duck and a dead doctor alike? Because they have both stopped quacking.

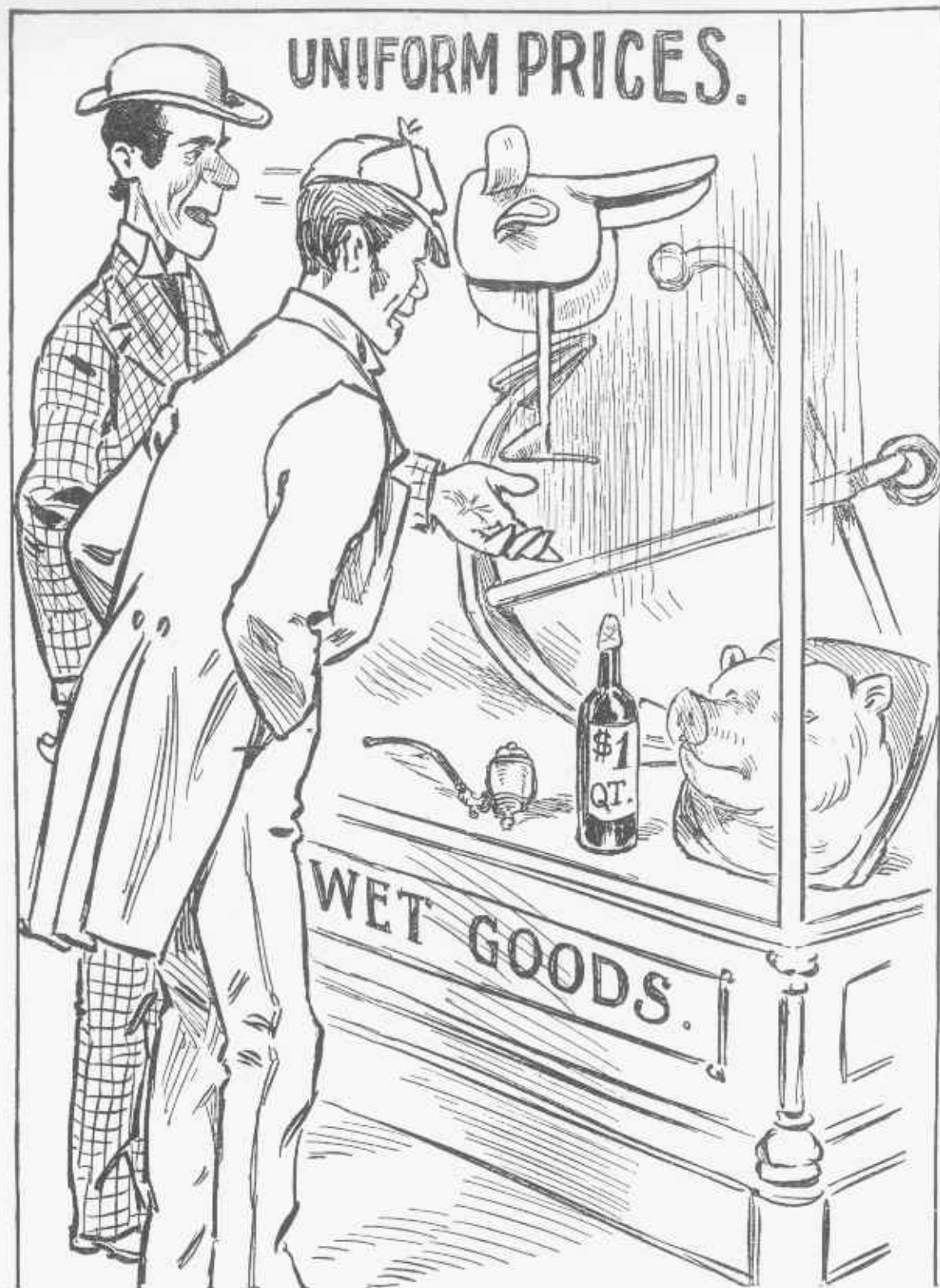

PROPOSITION—How can you tell the price of every article exhibited in the window?

Speaking about the crude, not to say almost primitive ways they have of conducting business at the Klondike, out mutual friend Jones, I assume that every one knows Jones—who has just returned, tells me that they are great sticklers for "uniform prices," as they term it. Jones says—and you can see veracity stamped all over his face—that you can look into any store window and tell the price of every article, whether marked or not. In proof of the assertion he showed me the accompanying picture, and told what every article would be worth, if charged for according to the "uniform price system."



PROPOSITION—Explain how Columbus showed his egg trick.

RECENTLY CAME across a vividly written description of the fifteenth century craze for gambling, wherein among other games of skill or chance upon which the cavaliers were wont to bet so recklessly, mention was made of the sport of laying eggs upon a cloth. Here possibly was the true solution of the Columbus egg story, which despite its clever moral has always seemed too tame for such a fierce period. I saw that there was a pretty principle involved and present it as a clever souvenir of the fifteenth Century, which differs from ordinary tricks and puzzles in that it calls for ingenious and original lines of thought instead of experimental methods. As a matter of fact, in place of a practical demonstration, our puzzlists are merely called upon to exercise their wits in suggesting the best theory or principle whereby to solve the problem, for a clever person should guess the puzzle from the picture.

It is simply a game to be played between two opponents placing eggs alternately upon a square napkin in order to see who can win by placing the last egg. After an egg is placed it must not be moved or touched by another one, but as the size of the napkin or the eggs, as well as the variable distances which may occur between them, is of no

importance, it would look as if the question of placing the last egg was a matter of luck or chance, and yet the winning trick, as the great navigator remarked, "is the easiest thing in the world when you are shown how!"

A CHARADE.

When whole what sweetness I exhale,
Beheaded, numbers use me,
Restore my head, and take the tail,
To dress but few refuse me.
Ans. 16, 9, 14, 11.

A REBUS.

Complete I'm an eastern trading mart,
Curtail, and of poems I form a part,
Again curtail, and you'll quickly see,
Affected phrases and tones in me;
Curtail once more, and I stand reveal'd
A welcome guest in the harvest field.
Cypher Ans. 3, 1, 14, 20, 15, 14.

A CHARADE.

My first's a public kind of carriage;
My second oft results from marriage;
My whole is useful all arow,
Though kicked and trampled any-how!
Cypher Ans. 3, 1, 18, 16, 5, 20.

Why is a fretful man like a hard-baked loaf? Because he is crusty.

A CHARADE.

My hoarding first's no miser, you will own;
My next's a portion of each lady's gown,
Should you grammarians, not content with this,
A different kind of definition wish,
'Tis here,—an article my first you'll find;
My next a pronoun of the plural kind,
When pious thoughts your hearts with warmth inspire,
Sweet bursts my whole from every sacred choir.
Ans. 1, 14, 20,—8, 5, 13, and 1, 14—20, 8, 5, 13.

Why is a fire-cracker like death? Because it's a debt o' natur (detonator)!

A CHARADE.

I am a dame
With pretty name;
But once curtail,
And I'm a male.
The answer to this charade might be her, hen, lady, or sultana, but there is a better word, so try and find it. We might also reverse the proposition and say: there is a word of feminine gender, curtail it and it becomes a feminine one.

Why are feet like olden tales? Because they are leg-ends (legends).

LOST OPPORTUNITIES



PROPOSITION—Show how Cholly Slowpop slipped a cog.

AS SHOWING THE practical value of conundrums and that class of wit-sharpeners, I wish to tell how Cholly Slowpop missed his opportunity and got himself disliked. He was enjoying a tandem ride with a charming young lady the other day, and, getting caught in that terrific storm, they were compelled to seek the shelter of a tree.

Just to keep the conversation from lagging, the young lady asked Cholly why it is that stolen kisses are considered the sweetest.

Cholly, who is a collegian, said that he supposed it was due to the natural perversity of human nature, and not to any extra sweetness in the mere performance of the oscu-

latory process, and proceeded to quote "Professor Huxley on the inherent desires for things which are supposed to be unattainable," which did not interest the young lady, who changed the conversation by asking why they were both like a tempting piece of fruit she discovered on the tree. Cholly thought it was a quince, and moralized upon it from that standpoint. Then she asked him if he could tell what kind of animals fell from the clouds, and he said that frogs were supposed to come down that way. Then the young lady said they might as well ride home in the rain, which they did, in silence.

Believing that there were better answers to the last two conundrums, clever readers to tell Cholly Slowpop what he should have replied.

Those who have met me do not wish for me;
Those who have met me do not wish to lose me;
Those who gain me have me no longer?
Lawsuit.

If you meet a pig in tears, what animal's name might you mention to it? Pork you pine!

HIDDEN NAME.

To give our class in concealed geography a very simple lesson we will take a look at the following peaceful scene. We do not find a hidden city in the description of this picture, nevertheless our clever puzzlists who are up in geography can locate the scene properly.

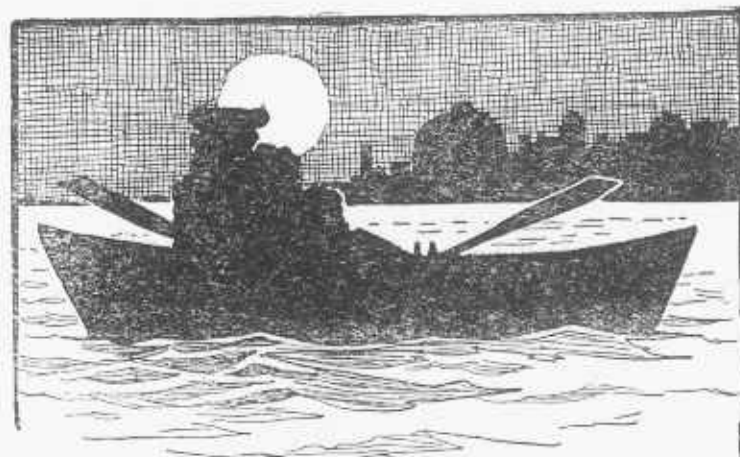

Drifting with the stream they fear no danger.

DIVIDING THE SPOILS

PUZZLE BY
SAM LOYD.

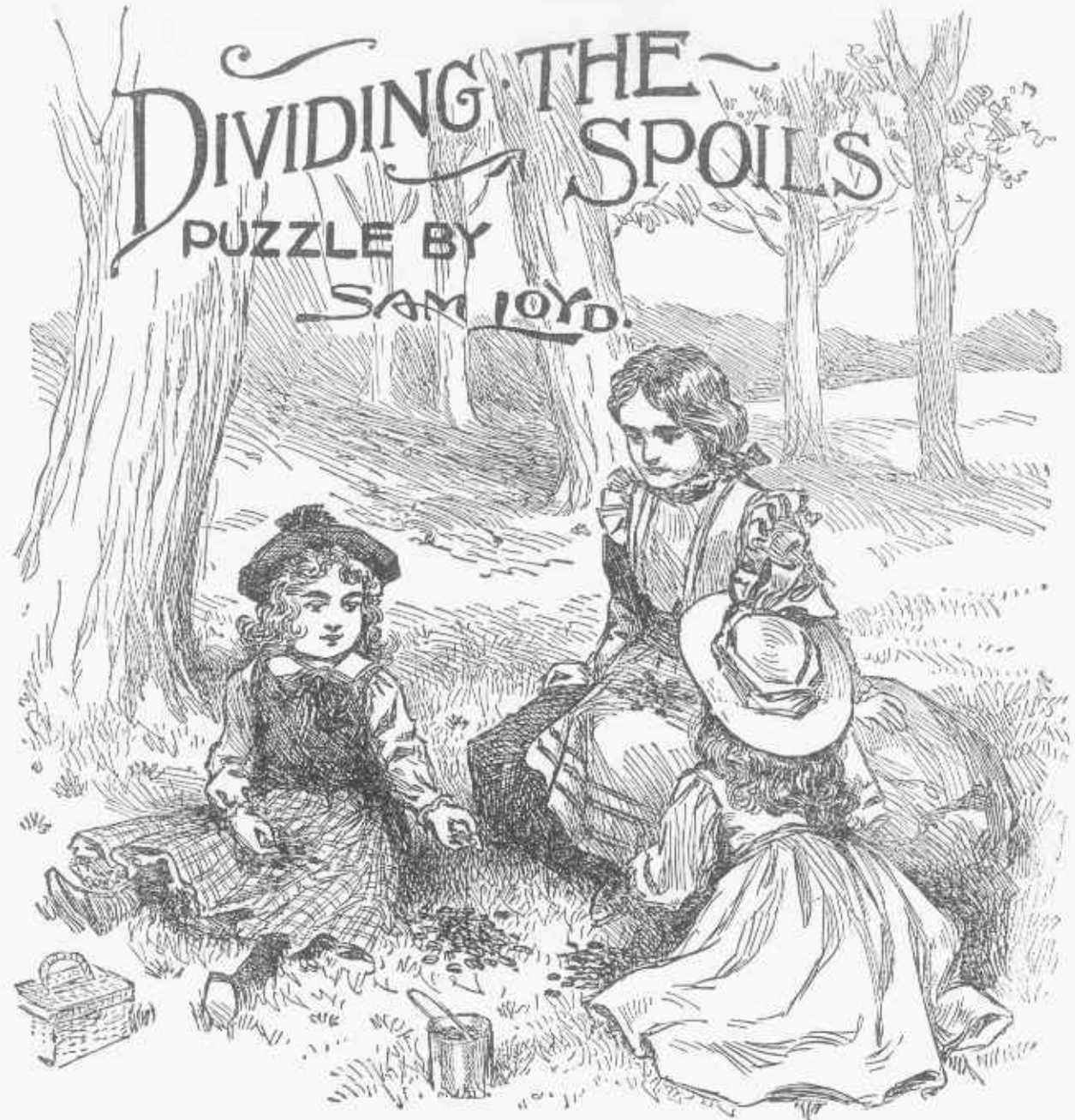

PROPOSITION—Dividing the chestnuts according to their ages, Nellie takes 3 as often as Mary takes 4, and to every 6 that Mary gets Susie takes 7. What is the age of each?

THERE IS AN INTERESTING age puzzle told about three little chestnut hunters who agreed to divide the spoils in proportion to their ages. It makes a pretty problem which will puzzle some folks who are pretty well up in mathematics, but these little girls had never bothered their heads about arithmetical problems; they did not even take the trouble to ascertain that they had gathered in all 770 chestnuts; they just proceeded to divide them up according

to their ages, so, as often as Mary took four, Nellie took 3, and, to every six that Mary received, Susie took 7.

The problem is to tell just how many chestnuts each little girl got, and what were their respective ages. Their mothers could do the latter part of the problem, but it is a pretty safe guess to assume that their parents could not so readily figure out the other part of the problem which the little tots have solved mentally or practically without pencil or paper.

A CHARADE.

Behead something irritating and leave something soothing.
Cypher Ans. 20, 5, 1, 19, 9, 14, 7.

What does an iron-clad vessel of war, with four inches of steel plating and all its guns on board, weigh just before starting on a cruise? She weighs anchor.

Why is a sick eagle flying like a robbery? Because it's an ill eagle (illegal) proceeding.

What beats a good wife? A bad husband.

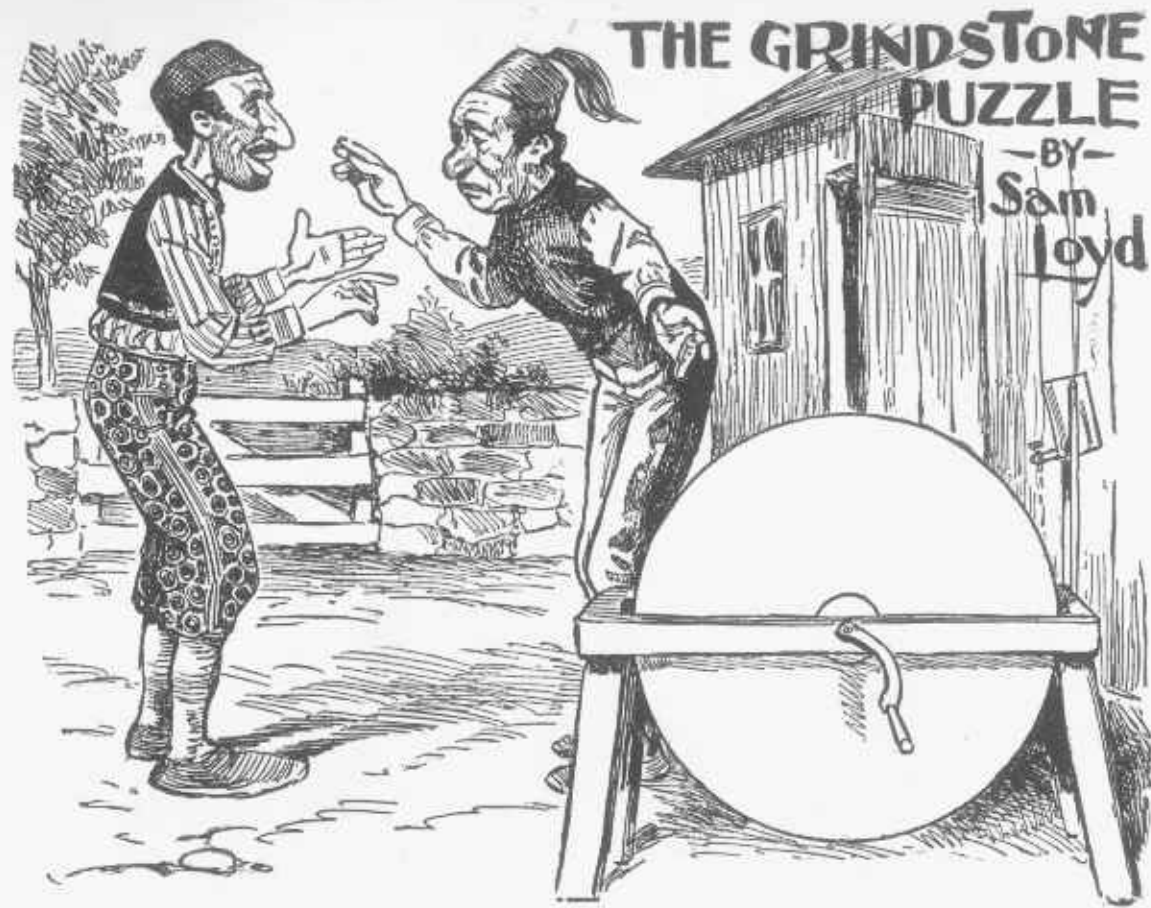

THE GRINDSTONE PUZZLE

—BY—
Sam Loyd

PROPOSITION—Show how to use up half of the grindstone.

WE CALL ATTENTION to the following little little grindstone puzzle given just to show that the great bugaboo of squaring the circle can be explained and taught in a simple way, so as to be of inestimable service in the ordinary workshop.

It is told that two honest Syrians pooled their issues and bought a grindstone, but as they lived several miles apart, they agreed that the elder man should keep the grindstone until he had reduced it in size just one-half, when it should be turned over to the other.

The grindstone was exactly 22 inches in diameter, with a 3 1-7 hole in the center for the shaft, as shown in the picture. What would be the size of the stone when given to the second owner?

Hoch Der Kaiser.

To familiarize our young folks with the geography of the world, they are presented with another lesson in hidden cities. They are asked to discover in the description of the picture the locality of a noted city, where I remember to have seen Prince Henry

riding in state with the royal family, followed by a great multitude shouting "Hoch der Kaiser!" which, as you all know, means "Hurrah for the Emperor!"

Which dress lasts a lady the longest? Her house dress, because she never wears it out.

Why should a disabled sailor go into business in a small way? Because he cannot be a whole sailor.

Why is an old bachelor always in the right? Because he is never mis-taken.

When is a young lady not a young lady? When she's a sweet tart (sweet heart).

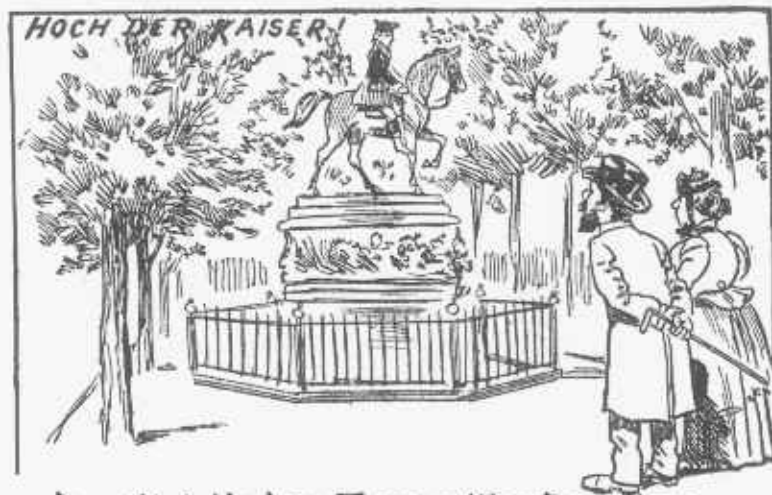

Beautiful Linden Trees, without number,
line the avenues.

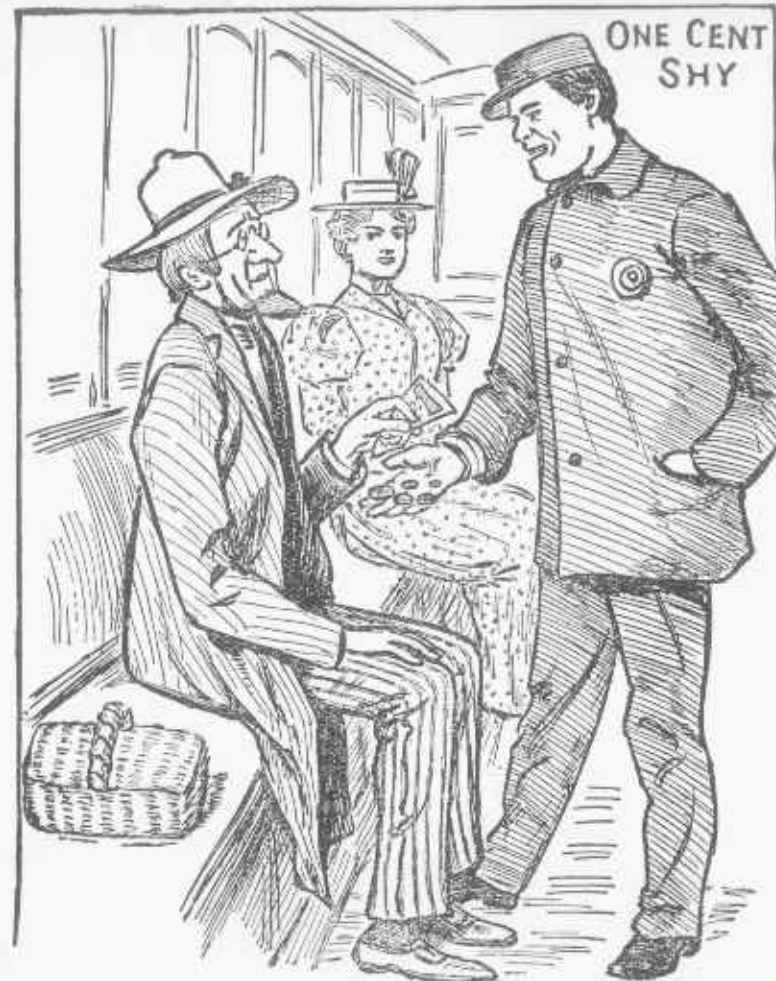

ONE CENT SHY

PROPOSITION—Tell what money the conductor must have had.

I WAS RIDING IN A car the other day when I saw a fidgety old gentleman paying his fare with a one dollar bill. The conductor had only 94 cents, but could not make the situation clear to the nervous old gentleman. Can you throw some light on the transaction by telling what money the conductor must have had?

CHARADE.

My first may be borne by some sorrowful hack,
Which adds to his cares, and the sores on his back;
But ah! should he feel all the weight of my second,
His misery, nearly complete, may be reckoned;
My whole often adds to your pleasure or pest;
No more need I say—you'll soon find the rest.

Cypher Ans. 16, 1, 3, 11, 1, 7, 5.

When does a man cease to become a man? When he turns into a lane.

What is the difference between an auction and sea-sickness? One is the sale of effects, the other the effects of a sail.

What is the difference between a blind man and a sailor in prison? One cannot see to go out and the other can't go out to sea.

One Thing at a Time.

I am reminded of a simple yachting puzzle which was sprung upon me the other day during a conversation with one of the visiting yachtsmen. I was invited to inspect the Shamrock, and in reply to casual comment upon the fact that the yachtsmen could not be drawn into an expression of views regarding the merits of the boats, my friend remarked: "You do not understand us Britishers; we are not so taciturn as you suppose, but an Englishman has a habit of doing but one thing at a time, while you Americans do a dozen things at once. An Englishman never talks while he eats or smokes, while with you it is looked upon as the most favorable time for conversation. I remember being on a cruise with Sir Thomas," he added, "when we smoked for two hours without saying a word, and as long as we had tobacco we smoked in silence." I made a note of the incident for our young puzzlists, and will ask them to discover the locality cleverly concealed in the remark.



ONE THING AT A TIME.

As long as we had tobacco we smoked our pipes in silence.

THE
ORACLE
PUZZLE
BY
SAM LOYD.



PROPOSITION—How large will their flocks become?

THE IMPLICIT FAITH which the ancient Greeks, Romans and Egyptians placed in the oracles of their gods can best be appreciated when we realize that from the declaration of a war down to the trading of a cow, no transaction of any kind whatever was undertaken without the advice and approbations of the oracles. In the famous painting of Zeus (Jupiter) at Dodona, two peasants are shown to be consulting the oracle about some trifling affair, and are directed in a commanding way towards a mirror of polished steel.

To illustrate the overwhelming importance and dignity, or rather of mystery with which things of insignificance were surrounded, the puzzle sketch is given as showing two poor peasants who wish to know whether the great Jupiter will smile auspiciously upon the purchase of a little lamb and goat!

"They shall increase," said the oracle, "until the sheep multiplied by the goats show a product which, reflected in the sacred mirror will show the number of the entire flock!"

There is a certain ambiguity and

mystery about the words of the oracle, nevertheless it seemed to be understood by the peasants that prizes would be distributed among those who mastered the problem, so we present it for the consideration of our puzzlists.

How to swallow a door. Bolt it.

Juvenile Criss-Cross Puzzle

Here is another missing-word or "neck-tie puzzle" as it might be termed, for the young folks to ponder over. Find a word which when placed in the vacant space on the bow, by being read twice makes the sentence correct by going around the circle.



THE SEDAN CHAIR PUZZLE.

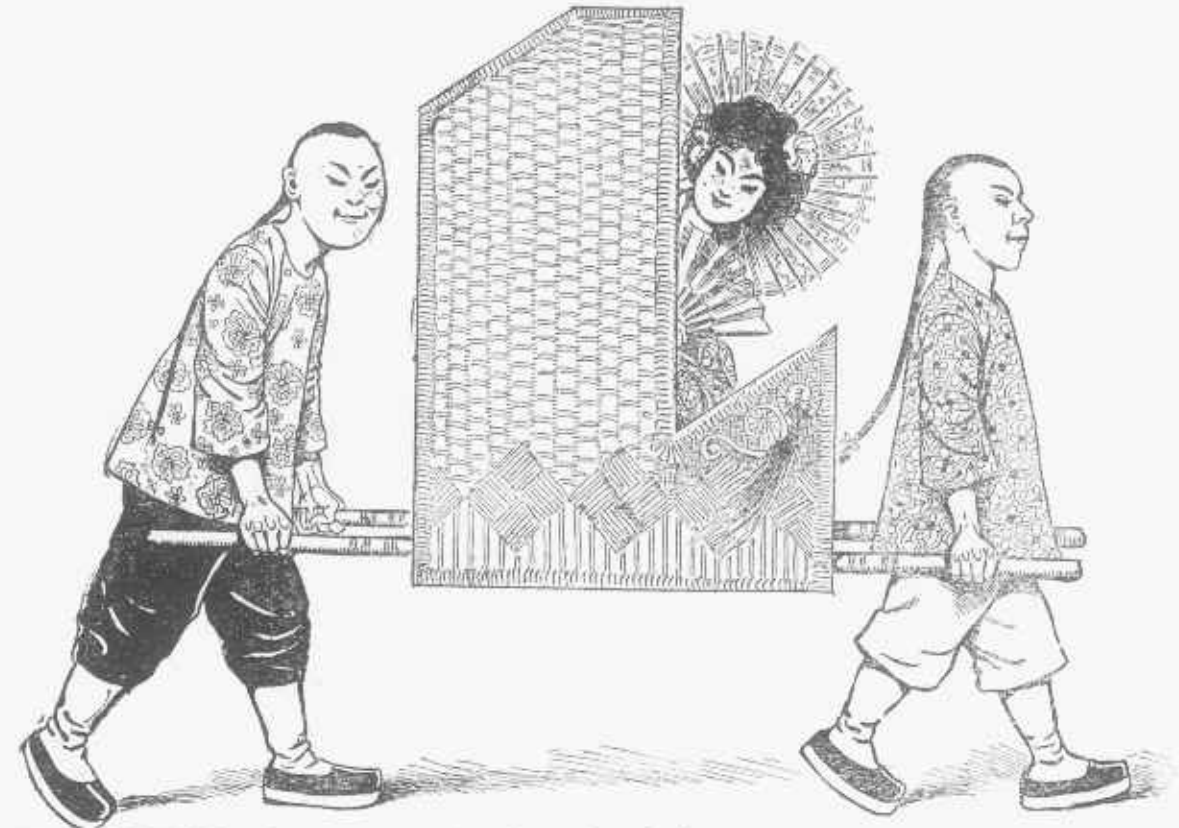

PROPOSITION—Show how to close the sedan chair.

SPEAKING ABOUT the modes of conveyance in China," says a writer who has spent the most of his life in the Flowery Kingdom, "one soon gets used to being carried around in a sedan chair, which is far more comfortable and expeditious than a hack. These chairs are made of rattan wicker work and remind you very much of those little Chinese puzzle boxes, made of colored straws so cleverly put together that you cannot discover where they are joined together"—all of which is very suggestive of a clever puzzle, for those sedan chairs will close up so as to make a covered box when it rains, and yet the closest examination will not detect where the pieces are joined. To illustrate the puzzle you are asked to cut the sedan chair into the fewest possible pieces, which will fit together and form a perfect square, so that the men will appear to be carrying a closed box.

What is a young lady who refuses you? Much too "no"ing.

Students of concealed geography are given an opportunity to find the locality from whence Barnum was once compelled to lead an obstinate elephant which had taken a dislike to railroading.

What is the difference between a spendthrift and a pillow? One is hard up, the other is soft down!

Which is the most difficult river to cross? The Arno, because there Arno boats there!

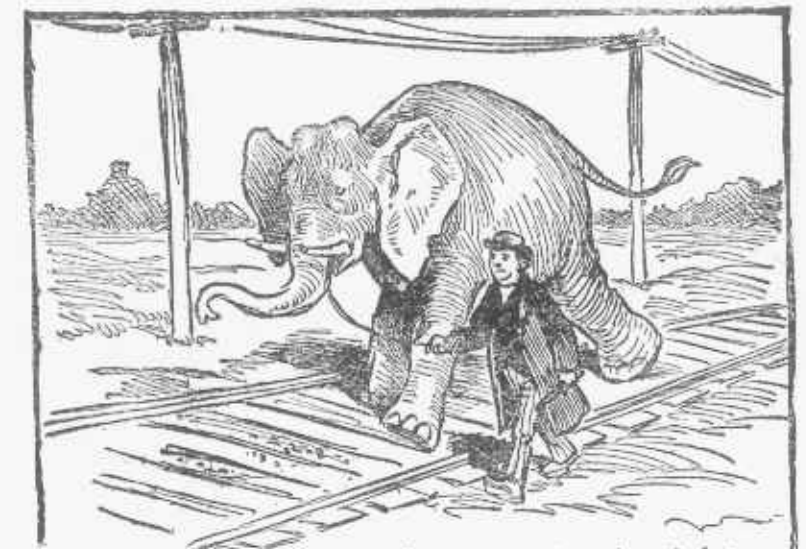

When Barnum brought Jumbo on to New York.

A CHINESE SWITCH-WORD PUZZLE

BY SAM LOYD



PROPOSITION—Select a twelve letter word and change its position in the fewest number of moves.

HERE IS AN INTERESTING word puzzle built upon the lines of my old 14-15 puzzle, in that there is supposed to be a letter placed upon each of the twelve moveable blocks, which reading from top downwards spell a correct word. The puzzle is to slide them about in a groove so as to make the word read correctly from the left to the right.

It will be readily understood that any twelve-letter word may be employed to solve the puzzle, but that every word will produce different results, so that some words will be better than others, and it is largely a matter of luck and experiment to see who can hit upon the best word which will solve the puzzle in the fewest possible number of manipulations.

More Trouble.

I will ask our young puzzlists to discover the locality of another matter which seems to be very perplexing. I was reading about the opinions of a returned missionary, for many years a resident in China, who says: "The Boxers really had but little to do with the recent disturbances. The Orientals, as a class,

are so extremely ignorant and superstitious that any little incident like the stealing of an apple by a monkey is liable to incite a riot, which, being attributed to the influence of evil demons, is liable to lead to massacres and rebellion. I am certain that more trouble is brewing."

From the positive manner in

which he makes this prediction, it is safe to say that he has inside information about somebody's monkey having stolen an apple, so I shall ask our juvenile puzzlists to ponder over the descriptive sentence of the picture in hopes of discovering the concealed locality of the prospective rebellion.



"Mama, the monkey ate my apple, core and all."

GOOD LUCK

THE GREAT HORSE SHOW PRIZE PUZZLE BY SAM LOYD



PROPOSITION—With two straight cuts divide the horseshoe into seven pieces, with one nail hole in each piece.

HERE IS A SOUVENIR puzzle based upon the goblin story of "The Golden Horse-shoe," which told how it was cut into seven pieces, with a nail hole in each piece, by two strokes of a sword, and how the seven pieces were then suspended by ribbons around the necks of the seven children, as lucky talismans.

It is to be assumed that after giving the first cut the pieces may be piled up before giving the second blow, so as to divide those first pieces again, but the cuts must be straight and there must be no folding or bending of the paper. I showed the puzzle to a clever little jockey at the recent Horse Show. He made a paper horse-shoe, and with the first cut divided it into three pieces; then

by laying them together, by the second cut he succeeded in getting six pieces. The trick, however, is to get the seventh piece, and while it is really a simple puzzle it is sufficiently interesting to call for some little study.

After you have solved the puzzle as stated, you are invited to try a second stipulation of the problem which is more difficult to discover. In how many pieces can the horse-shoe be divided by two straight cuts?

Why is a plum cake like the ocean? Because it contains many currants.

What street in London puts you in mind of a tooth which has pained you for a long time? Long Acre.

Why does an aching tooth impose silence on the sufferer? Because it makes him hold his jaw.

A REBUS.

A selfish, idle race are we
And sots in us their image see;
But place the head upon the tail,
And when we're advertised for sale,
Ye sons of luxury, beware!
Destruction spreads a tempting
snare.

Cypher Ans. 19, 23, 9, 14, 5.

What kind of essence does a young man like when he pops the question? Acqui-essence.

What is that which by losing an eye has nothing left but a nose? A noise.

Why are the makers of the Armstrong gun the most dishonest persons in Her Majesty's service? Because they rifle all the guns, forge the materials, and steel all the gun breeches.

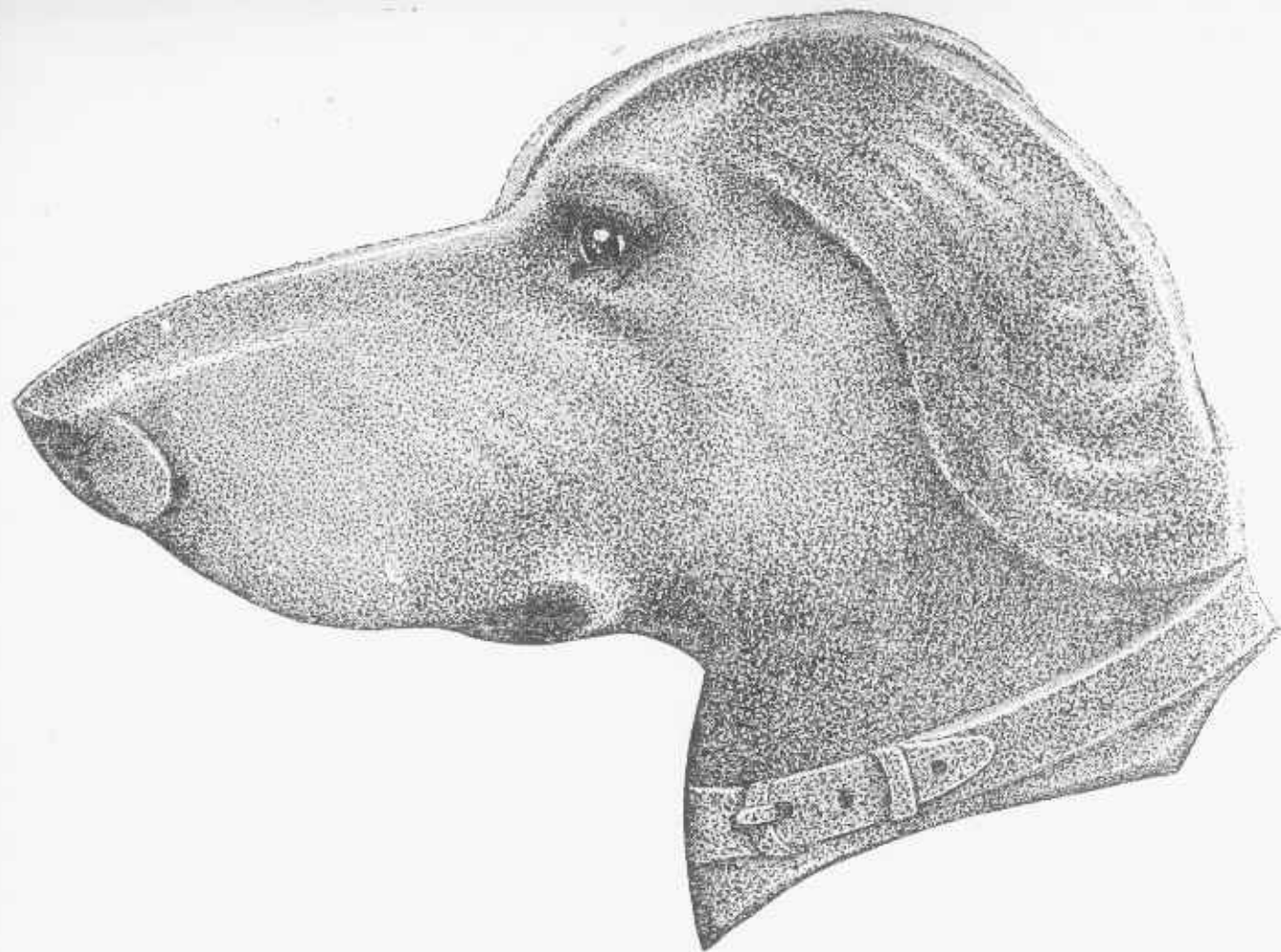

PROPOSITION—How would you cut this gingerbread dog's head into two pieces of the same shape?

HERE IS A PRACTICAL problem in simple division which is calculated to baffle some of our young puzzlists for the reason that it will not yield to ordinary arithmetic. You see, Toodles has received the present of a gingerbread dog's head and is told that she must divide the same evenly with her little brother. In her anxiety to be fair and equitable in the matter she wishes to discover some way to divide the cake into two pieces of equal shape and size.

How many of our clever puzzlists can come to her assistance by showing how the dog's head may be divided into equal halves?

My first makes company,
My second shuns company,
My third assembles company,
My whole puzzles company,
Co-nun-drums.

Name that which with only one eye put out has put a nose left?

THE KINGS.

Our study in concealed geography presents two ancient and famous racers, so the problem is for our

young friends to discover something about their pedigree by finding the scene of their prowess hidden in the description of the picture.

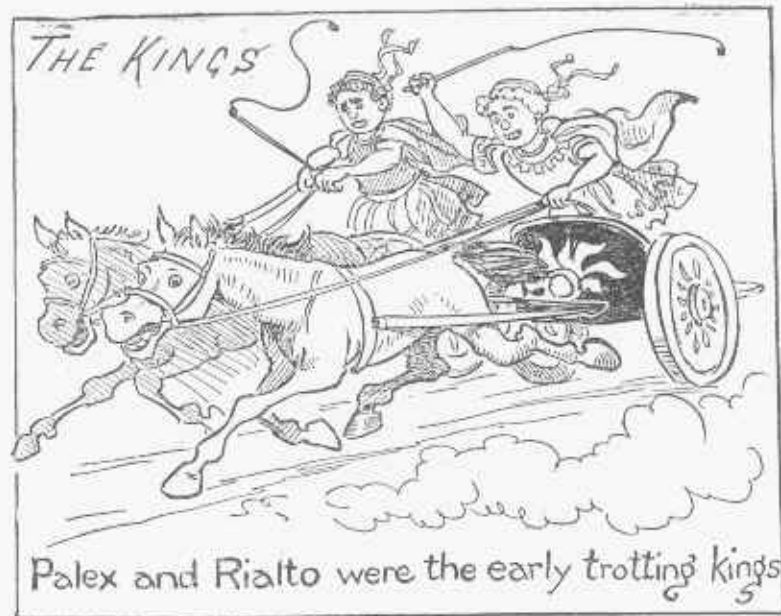

Palex and Rialto were the early trotting kings



A REBUS.

My first's an ugly insect,
My next an ugly brute;
My whole an ugly phantom
Which naught can please or suit.
Cypher Ans. 2, 21, 7, 2, 5, 1, 18.

What is more wonderful than a horse that can count? A spelling bee.

Why are tallest people she laziest? Because they are always longer in bed than oshers.

How can hunters find their game in the woods? By listening to the bark of the trees.

Here is a study in concealed geography which illustrates an incident in the early career of Russel Sage, when he seized the opportunity of working his way eastward by leading a mule along the tow path. It is said that it suddenly dawned upon him that it was a case of a donkey leading a donkey, for if he had to walk he might as well do it without leading another donkey, so he struck out for himself at a certain point, which will be found in his description of the sketch.

A REBUS.

My first is found in the ocean wave,
As well in the pit and the mine;
My second below the surface we have
Where never the sun can shine.
My whole the festal board to grace
But seldom fails to find a place.
Cypher Ans. 19, 1, 12, 20, 3, 5, 12,
12, 1, 18.

When is a baby like a breakfast cup? When it's a tea thing (teething).

Why does a baby boy always receive a hearty welcome in a family? Because it never comes a-miss.

What kind of medicine does an Irishman take for a scolding wife? He takes an elixir (he takes and he licks her).

When is a sailor like a corpse? When he is in the shrouds.

When is a sick man a contradiction? When he is an impatient patient.

What does an artist like to draw best? His salary.

Why does a man think of his mother's slippers when he handles the lines behind a fine, well-matched pair of horses? Because they are such a spanking pair.

Why is a committee of inquiry like a cannon? It makes a report.

CONCEALED GEOGRAPHY.

- 85. That little brat is bonneted with a stocking.
- 86. A surveyor, looking at the debris, told me the wreck was fearful.
- 87. Sacred music owes much of its success to the opera.
- 88. Let no woman or man dye their hair. (Province.)
- 89. Several banian trees were required to shelter the Fakir of Ava. (Country.)
- 90. It is said that Nepos tended bar at Rome.
- 91. One lie generally necessitates many.
- 92. Men are ruined through entertainments of too great magnificence.
- 93. If you want an answer from a daw, ask a question. Caw, caw, caw.
- 94. You must hang in the hall a brad or tack to put hats on. (Country.)
- 95. A mad dog ran a dangerous race with a policeman.
- 96. The ill-fated Io was changed, by Juno's jealousy, to a heifer. (State.)
- 97. Let me use my own means. (River.)
- 98. France has been our ally on several occasions.
- 99. Man is a creature of a day.
- 100. France is treacherous, but Prussia may perhaps be trusted. (Country.)
- 101. Never is error long triumphant. (River.)

Spell one word with the letters: Great helps. (Telegraphs.)



Like a weary traveler,
I entered the town.



A simple but interesting problem developed from a thrilling adventure which befell me during my ascent of the pyramids. The guide, as you may observe, was armed with a sword for the purpose of slaying any lions which might come our way, and it was stipulated that I was to have the skins from any we might capture. We were just preparing to climb the smaller of the Cheops when one of the beasts which infest that neighborhood came in view. I hastened to the top to place my belongings in safety, taking five steps at a time, my guide six, and the lion seven. The situation is somewhat complicated, as the sketch shows that none of the measurements will bring any one of the parties to the exact summit. Nevertheless, despite the fact of the lower steps being out of view, you will find sufficient data to estimate the exact height of that little pyramid.

I may say incidentally, that the rascally guide whom I instructed to save the lion's skin while I deposited my belongings in safety must have stolen the same, as I never saw him again.

A REBUS.

Let go! let go! you naughty first,
In my gown you'll cause my second,
And make my wrath impetuous
As my whole is ever reckoned.
Ans. 3, 21, 18, 18, 5, 14, 20.

A CHARADE.

In Africa once, delighting to range,
On the tail of my owner I sped!
But now I adorn, oh wonderful change,
Instead of the tail, a new owner's head.
Ostrich feather.

Why does a railway official punch a hole in your ticket? To let you through.

A REBUS.

In olden days great was my power,
Oft have I saved the embattled tower
From the invading foe;
Transpose me, ah! how great my fall,
I am then the smallest of the small,
And lowest of the low.
Ans. 13, 15, 1, 20.

To give the young folks a chance to exercise their ingenuity, it may be said that Dauber, the artist, is back from Europe, where he has been studying the old masters. He brought a portfolio of paintings which bear witness to his industry, but when he showed me a picture of a deer sketched from life, and offered to bet I could not guess where he painted it, I said Dusseldorf at once, for I have seen a class of twenty sketching that same picture at the Academy, many moons before he was born.

How many of our puzzlists can discover the locality of the scene of the painting concealed in the description.



Art class (at Dusseldorf) in landscape painting.

A REBUS.

Entire I am capital; curtail me
and I am capital still, but behead
and transpose me and I am looking
for capital. Ans. 6, 21, 14, 4.

A CHARADE.

My first is four-sixths of a step that
is long,
My second a person of state;
My whole is a thing that is known
to be wrong,
And is a strong symptom of hate.
Cypher Ans. 19, 20, 18, 9, 11, 9,
14, 8.

A REBUS.

My first when in a circle found,
Betakes to whirling round and round
My second, elevated high,
Calmly surveys the passer by;
My friendly whole acts like a brother
Not for himself, but for another.
Cypher Ans. 19, 16, 15, 11, 5, 19, 13,
1, 14.

If I were to bite off the end of
your nose what would the magis-
trate compel me to do? Keep the
peace (piece).

Why is a child with a cold in its
head like a winter's night? Be-
cause it blows, it snows (its nose).

Why are the complaints of mar-
ried people like the noise of the
waves on the shore? Because they
are the murmurs of the tied (tide).

When is a lover like a tailor?
When he presses his suit.

How many peas would you sup-
pose there are in a pint? One P.

Why is a man committing murder
like a hen walking across the street?
Because it's a foul proceeding.

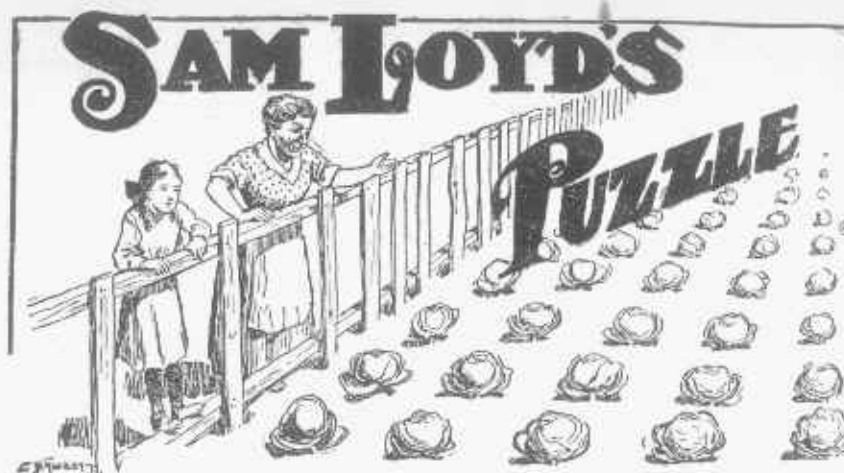

In this odd little puzzle, which is a simple but instructive one, Mrs. Wiggs is explaining to Lovey Mary that she has a larger square cabbage patch now than she had last year, and will therefore have 211 more cabbages.

How many of our mathematical experts and agriculturists can estimate upon Mrs. Wigg's crop of cabbage heads so as to get a line upon the Saurkraut Trust?

A CHARADE.

On the casement pane the wind beat
high,
Never a star was in the sky;
All Kenneth Hold was wrapt in
gloom,
And Sir Everard slept in a haunted
room.
I sat and sang beside his bed;
Never a single word I said,
Yet did I scare his slumber;
And a fitful light on his eye full
glistened,
And his cheek grew pale as he lay
and listened,
For he thought and he dreamed that
the fiends and jays
Were reckoning o'er his fleeting days,
And telling out their number.
Was it my second's ceaseless tone?
On whose small hand he laid his
own—
The hand which trembled in his
grasp,
Was crushed by his convulsive clasp.
Sir Everard did not fear my first,
He had seen it in shapes that men
deem worst,
In many a field and flood;
Yet, in the darkness of his dread,
His tongue was parched—his reason
fled;
And he watched, as the lamp burned
low and dim,
To see some phantom, great and
grim,
Come dabbled o'er with blood.

Sir Everard kneeled, and strove to
pray,
He prayed for the light of early day,
Till terror checked his prayer;
And ever I muttered clear and well,
"Click, click," like a tolling bell,
Till, bound in fancy's magic spell,
Sir Everard fainted there!
Ans. Death-watch.

A REBUS.

Without my first, I'd have you know
My beard a frightful length would
grow;
Discordant noises from my next
Might make you feel annoyed and
vexed;
My whole's the best—you need not
doubt it,
For he's a rogue who is without it.
Cypher Ans. 8, 15, 14, 5, 19, 20, 25

Here is an opportunity for the
concealed geography class to display
cleverness in discovering the locality
of the scene depicted in the sketch.



A REBUS.

Of my first, very often, in triumph
you boast;
My next, when beloved, is some-
times your toast,
As gaily the glass passes round,
In my whole the fair ladies do al-
ways delight,
And with youth, rank and fash'on,
both morning and night,
I may certainly always be found.
Cypher Ans. 6, 5, 1, 20, 8, 5, 18.

A CHARADE.

A source of joy my first may be,
Or of acutest agony;
With my second it is said
The innocent are oft betrayed;
My whole when exquisitely sweet
With sparkling beauties is replete.
Ans. 19, 15, 14, 14, 5, 20.

A REBUS.

Within my first is often placed,
What from my next is taken;
And both are usefully employed,
To cook your beef and bacon!
My whole you'll find—no matter
when,
The first production of your pen.
Ans. 16, 15, 20, 8, 15, 15, 11.

Why is an oyster an anomaly?
Because he grows a beard without a
chin, and you take him out of his
bed to tuck him in.

Tell us the difference between a
good and a bad oyster? One is a
native, the other is most certainly a
settler!

I called to my second, requesting
him to clean my first, before which
it was necessary that he should
bring my whole. Boot-jack.

I WAS USHERED IN- to this world in 1853. This was in the olden slavery days, but the bloody war that liberated so many others brought no such boon to me. I have served many masters and, though it may not become me to say so, I have always been good and as efficient as my natural limitations would permit, for, although I was not deformed, I was considerably smaller than others of my family. Though I always did my duty faithfully, such is the world's ingratitude that few of my masters hesitated to get rid of me.

The first one I remember was a Southern planter who spent most of his time in barrooms. He was an inveterate gambler. He took me with him to a saloon one day. He had been losing heavily and was in a bad temper. He tried to vent his spleen on me, and seizing me, threw me up into the air so I landed on my head while the stars danced about me. I turned tail at this, and left him casting my lot in with one of his companions who seemed to be less of a brute. But it wasn't long before he got rid of me to a tramp. My new master and I became very much attached to each other, and though we led a roving life, sleeping in barns and empty freight cars, I always had as much to eat as I required, and I felt sure that there must be many who were not a quarter as well off as I would who envy my lot. But my contentment was not to last long, for a few days later he traded me off for a pipe. Think of it, a mere wooden pipe! I grieved at what I then considered heartlessness, but contact with the world has since rubbed off all sentimentality and other ear-marks of youth.

I will not weary you with a history of all my wanderings. Suffice it to say, after many vicissitudes I reach reached New York, where I entered the service of a lady who kept a boarding house. I didn't stay long with her, for after a day or two she gave me to the butcher.

He got rid of me soon to a little girl whom her mother had sent for sausage, and I must confess I was not sorry to make the change, for my new owner had a kind face. When she brought me home her mother said that she might keep me for her very own and I began to hope that my roving life had come to an end. My chief objection was that she kept me in a dark closet in her room. I wondered if there were any

brighter quarters in the house, but if there were I never got a chance to see them, for I was kept a prisoner in this narrow cell where the only glimpse of light I got was when my little mistress opened the door to get out one of the many dresses that hung about me. But one day when she was giving a party to her girl friends she brought me out and proudly showed me to her companions. Immediately I became an object of envy and one little girl more eager than the rest to own me offered her bracelet for me which I am very sorry to say my little mistress accepted. But my new possessor was like all the rest,—she parted with me without a twinge, and I shall never forget my feelings when she passed me one day in a dry goods store while out shopping without even giving me a second look. I am tired of this world, but there is no help for me. I came from a long lived family and there seems to be no end to any of us. If I prayed to Fate to put an end to me I wonder if I would be refused.

A REBUS.

In fruitful field my first they grew,
My busy next there labored too;
A hardy race my whole you'll find,
To husbandry and peace inclined.
Cypher Ans. 16, 5, 1, 19, 1, 14, 20, 19.

Our class in concealed geography is asked to discover the hidden locality of a little incident which occurred when the much-married Brigham Young endeavored to escort his bevy of wives past a display of spring millinery.



Brigham led anything but a happy life there!

CONCEALED GEOGRAPHY.

Here is a collection of hidden cities, etc., for the juvenile class to discover in the sentences.

1. There is one thing you should be constant in—O plebeian!
2. The Empress Regent thinks she is a Maria Theresa.
3. Old wine, old books, old friends are the best.
4. Jump on, are you all on, don't forget the baby.
5. He used a new preparation for his teeth.
6. They say that our small dog is dead.
7. I galloped to Lynn and met Zechariah galloping back.
8. Lord Bacon was a great thinker many years ago.
9. King Alfred, in burgher cloths, burnt the cakes.
10. O mighty Tiber, gently flowing to the sea!
11. No knowledge, no attainments, can take the place of goodness.
12. The Crown Prince can even balk a Napoleon.
13. The amber lining of her coat was all faded.

A REBUS.

Here is an odd rebus which everyone cannot see through even when knowing the answer to be the letter R.

Whether old Homer tippled wine or beer,
Julep or cider, history is not clear;
But strange it is—the bard, though
wont to roam,
But for one liquid, ne'er had left home.

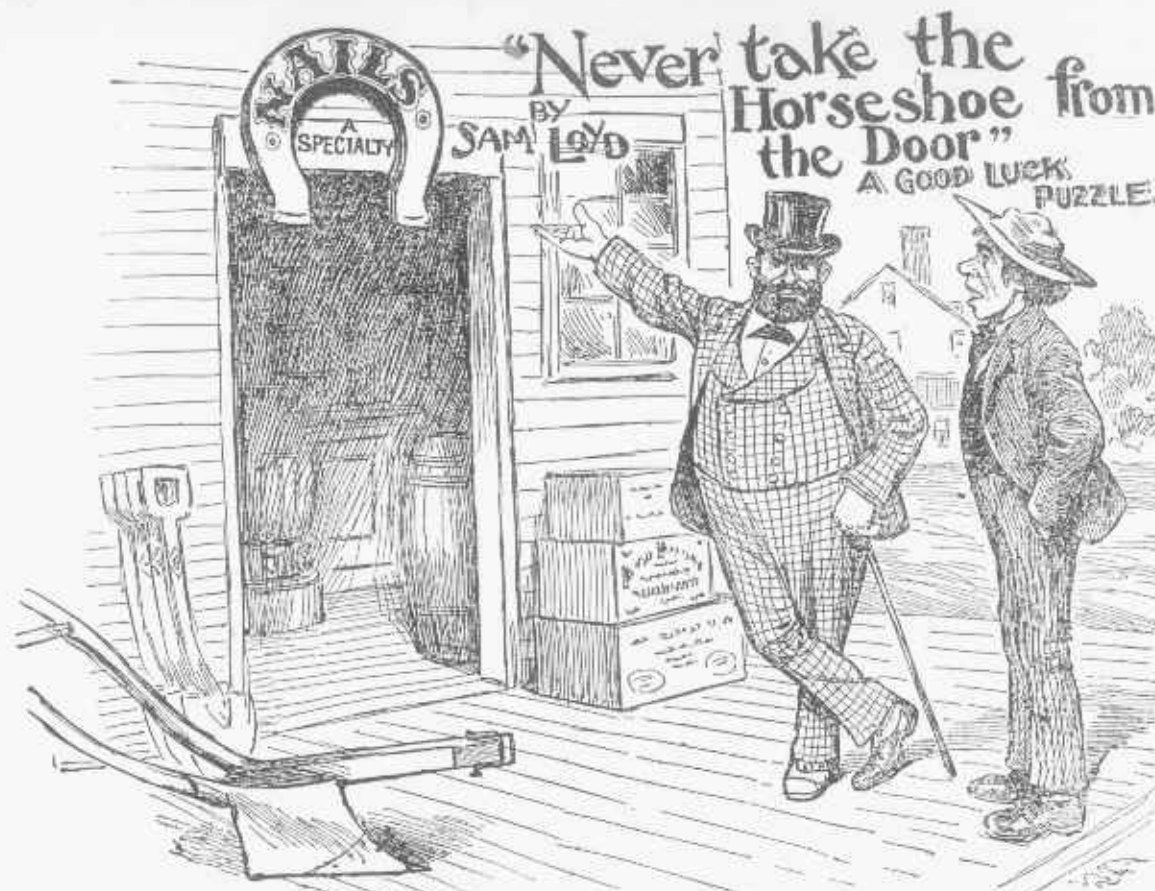

PROPOSITION—Evolute Pants into Nails in the fewest changes.



OUR GOOD LUCK Puzzle is based upon a commercial episode which I picked up some years ago in the wild and woolly West. In the character of a progressive young man in search of valuable information, I sought advice from the local magnate of the town, who had amassed a considerable fortune in the hardware business. The secret of success, he told me, was to take some one specialty and stick to it until you were king pin in that line.

I told him I had amassed seven cents, and was greatly puzzled as to the best plan for making a fortune out of it. He replied that it was a good puzzle, and advised me to stick to puzzles all my life, and never flatter myself that I had brains suited for anything else. And here I am.

In proof of this theory, he said that many years before, a tailor had built this store, and put the golden horseshoe over the door with Pants as the specialty. In five years he retired worth a million, and a liquor dealer took the store and by the changing of a single letter made Pints his specialty. Then came a florist, a jeweler, a plumber, a drug-

gist, a notary, a mason, an undertaker, a grocer, a shipbuilder and then the present specialist in Nails. Each man in rotation had changed but a single letter at a time. I have forgotten some of the different trades and professions, but our puzzlists are so clever in helping me out of just such dilemmas that I have concluded to offer prizes for the best answers. I heard afterward that Abraham Lincoln took the store and that it has gone through half a dozen changes since, in each and every case the incumbent retiring with fame and fortune.

How many can discover the sequences of changes of one letter at a time?

What female recluse is that whose names reads backwards and forwards the same? Nun.

What lady-like appellation reads backwards and forwards the same? Madam.

What time of the day spells forwards or backwards the same? Noon.

Why should fishermen become wealthy? Because their business which is all net profits, makes them sel-fish.

What has the baby got that spells forwards and backwards the same? Bib.

Wherein lies the difference between man and butter? The older a man gets the weaker he grows, but the older the butter is the stronger it becomes.

When did Caesar visit the Irish? When he crossed the Rhine and went back to bridge it (Bridget).

What light could not possibly be seen in a dark room? An Israelite.

Why is the Queen only a poor gentlewoman? She possesses but one crown.

Why is the letter B like a hot fire? Because it makes oil boil.

Why is an invalid healed by ocean bathing like a confined criminal? Because he is sea-cured (secured).

When does a public speaker steal lumber? When he takes the floor.

Why is the letter A like a honey-suckle? Because a B follows it.

When are two tramps like common time in music? When they are two beats to a bar.

Why is a ferry boat like a good rule? Because it works both ways.

What is always behind time? The back of a clock.

THE GORDIAN KNOT

A Classical Problem

—BY—
SAM LOYD



IF COURSE AT THIS late day it would be impossible to correct the great injustice done to poor Gordius, nevertheless, as true blue puzzlists we can condemn the high-handed manner in which Alexander the Great, competing in a puzzle contest, proceeded to make himself the umpire, and awarded the prize for his solution, which was as absurd as it was unfair. He established a dangerous precedent and encouraged a kind of puzzle brigandage which is not extinct to this day, as we often find young Alexanders, who would like to solve puzzles according to their own notions and capture prizes after the manner of pirates.

Gordius was an unsophisticated countryman, who raised sheep and grapes, but who by his extreme cleverness became King of Phrygia, and is known in history as the ploughboy king. It is told that when he assumed the sceptre he tied his former implements with what is known in history as the Gordian knot, but in such a peculiar way that the knots could not be unfastened and the oracles proclaimed that whoever could untie them would become the Emperor.

Alexander the Great, it is told, made many ineffectual attempts to untie some of the knots, but finally becoming enraged at his want of success, drew his sword and cut the

cord, exclaiming that "such is the common sense way to get a thing when you want it." Strange that those familiar with the story and its contemptible climax indorse it with a certain air of assumed pride when they have surmounted some difficulty and exclaim: "I have cut the Gordian-knot!"

According to historians and all writers on the subject the puzzle was a fair and legitimate one, and so accurately and minutely described that many attempts have been made to picture it, and some curious and complicated knots have been invented by imitators of Gordius. I wonder whether they would be satisfied with the answers to their puzzles if the solvers followed the methods of Alexander. The only protest against the solution to the Gordian knot, which I can recall, were some clever lines which must be of very ancient origin:

"A puzzle is not solved, impatient sirs,

By peeping at its answer in a trice—
When Gordius, the plow-boy king of Phrygia,

Tied up his implements of husbandry
In the far-famed knot, rash Alexander

Did not undo, by cutting it in twain.

In presenting the puzzle, I have drawn largely upon encyclopedia lore, but have conformed strictly to the description as I find it. They all agree that the cord was so fixed

that no ends could be found and that the implements of husbandry were tied to a staple in the temple of the gods. I have taken Lattimer's intimation that the implements may have been tied separately, and I accept his reference to the pruning shears as being worthy of special illustration, and the more especially as it is safe to say that all of our puzzlists can obtain assistance from their fair friends in the matter of accommodation with a pair of scissors.

The puzzle is designed especially for the summer outings, and should become popular at the seashore as well as at the mountain-resorts. It can readily be solved by patience, perseverance and quiet study. It is a puzzle to be solved in some quiet nook, "far from the maddening crowd." Get a piece of cord about one yard long, tie the ends together so as to make an endless piece. Take any kind of ordinary scissors and arrange the string exactly as shown in the picture, only instead of fastening the cord through the staple, throw it, like a necklace, over the head of a young lady, seated in a convenient position, who will aid you to win the crown of Asia by removing the scissors.

A man bought two fishes, but on taking them home found he had three; how was this? He had two—and one smelt.



Here is a pretty ante-nuptial perplexity picked up during my sojourn in the Old Dart, which is well worth presenting in puzzle form: "Now, Biddy darlint," said an Irish swain, "ye are so fond of tricks as well as Pat-tricks, I'd like you to riddle me wan that perplexes me entoirely: Wanst, when a week ago last Tuesday was to-morrow, ye said: 'When a day just two fortnights hence will be yesterday, let us get married, as 'twill be just this day nixt month.' Now, Biddy, I have waited just half that time, and ye have waited the same; so, as it is now the 2d of the month, I suggest, if your heart goes 'pitty-Pat,' we might figure out when that wedding day is due."

Who was the most successful financier mentioned in the Bible? Noah, because he floatd a limited company when all the rest of the world was in liquidation.

Why is a schoolmaster like the letter C? He forms lasses into classes.

Why is bread like the sun? Because it rises from she yeast.

When is a chair like a lady's dress? When its sat-in.

When is a soldier like a watch? When he is on guard.

When does a chair dislike you? When it can't bear you.

Why is a duel quickly managed? Because it takes only two seconds to arrange it.

If I were in the sun and you were out of it what would the sun become! Sin.

What disease are reapers subject to on hot days? A drop-sickle affection.

Why would an owl be offended at your calling him a pheasant? Because you would be making game of him.

Why is your nose in the middle of your face? Because it is the scenter.

When may two people be said to be half witted? When they have an understanding between them.

A RIDDLE.

An object for which many thousands do sigh,

A blessing I prove, or a curse;
And when to the alter of Hymen you hie,

You take me for better or worse.

I am of both sexes—both husband and wife,

You court me, you love me, you scout me;

I'm the source of much joy, contention and strife,

Yet few can be happy without me.

I travel by land—on the ocean I range,

With the fowls too, I soar in the air;

I'm constant, I'm fickle—too much given to change,

Therefore when you choose me—beware!

Ans. 13, 1, 20, 5.

A REBUS.

My first is a part of the day,
My last a conductor of light,

My whole to take measure of time,
Is useful by day and by night.

Cypher Ans. 8, 15, 21, 18, 7, 12, 1, 19, 19.

What burns to keep a secret?
Sealing-wax.

Why is a nobleman like a book?
Because he has a title.

Why is a nobleman like a book?
Because he has a title.

What class of women are most apt to give tone to society? The belles.

What is that by losing an eye has nothing left but a dose? A noise.

Why is a four-quart jar like a layy's side-saddle? Because it holds a gal-on (pallon).

Why are balloons in the air like vagrants? Because they have no visible means of support.

Why is a very amusing man like a bad shot? Because he keeps the game alive.

Which is the favorite word with women? The last one.

CONCEALED GEOGRAPHY.

102. The servant, Anna, polishes the plate.

103. Fear lest you aim too low.

104. Is Theodore gone already? (Territory.)

105. The power of riches terminates at a certain point.

106. A coon climbed up an upas tree.

107. On the river Volga there lived a man who was scorched by the Sirocco.

108. A peculiar aroma in every part of this piazza is observed in the evening. (State.)

109. I have a rough ague.

110. Ask me any question you like like, but I can't answer.

111. Prince Giglio left his love and Bulbo's to Nelly Bly.

112. In my room a harness hangs.

113. Will Robert Douglas go west if I smile sweetly on the Earl?

114. If you put a hat upon a shovel the toads will wink. (Territory.)

115. A woman called Miranda named her dog Victoria.

116. In rescuing the soldiers, he found the last one hampered by the baggage.

117. I like no liquor so well as Triate Sherry.

118. A woman dressed "a la mode" nature would never recognize.

119. Let the glorious King Philip arm a fleet instantly.

120. Having broken my right arm I landed without effecting my purpose.

121. A red-fringed Stanhope rug I anticipate by the next steamer.

122. Here, girls,—Mag. Deb,—urge on the cows.

123. I never could fancy Prussic acid. (Island.)

124. The magnanimous hero bleeds for his country.

125. In scanning, the Pyrrhic and Iambus are seldom used. (Island.)

126. An apple without a core, a pig would not reject.

127. A negro from Congo, Shennstone immortalized in his poetry.

128. A filigree ceinture adorned her lovely waist. (Country.)

129. An over-ripe cucumber never is fit for the ablte.

130. Gerzom was a huge or giant creature of antiquity. (State.)

131. O Catapult! O vast and mighty engine!

132. Let us form a convention to ameliorate the condition of the Chinese.

CHICKENS IN THE CORN

BY SAM LOYD



PROPOSITION—Show the good man and his wife how to catch the chickens.

WHEN WATCHING THE gambols of playful dogs, kittens and other domestic animals we are often impressed by the way they seem to enter into the spirit of the fun and enjoy the fine points of play, just as human beings do, and it is easy to detect a certain appreciation of the sense of humor in the exultation over the defeat or mishap of a playmate. But for a rollicking exhibition of mischief, or "tantalizing cussedness," as the farmer calls it, I have never seen anything equal to the sport produced by two obstinate chickens, refusing to be driven or coaxed from a garden. They neither fly nor run, but just dodge about, keeping close to their pursuers, so as to be out of reach. In fact, when the would-be captors retreat the chickens become pursuers and follow close upon their heels, uttering sounds of defiance and contempt. On a New Jersey farm, where some city folks were wont to summer, chicken-chasing became a matter of everyday sport, and there

were two pet chickens which could always be found in the garden ready to challenge any one to catch them. It reminded me of a game of tag, and was in many respects so like my old "Pigs-in-Clover" that I was continually twitted to "work it into a new puzzle." I have really concluded to illustrate a curious puzzle point suggested by those sportive chickens, which otherwise I should never have thought of, and which I am satisfied will worry some of our experts. The object is to prove in just how many moves the good farmer and his wife could catch the two chickens. The field is divided into sixty-four square patches, marked off by the corn hills. Let us suppose that they are playing a game, moving between the corn rows from one square to another, directly up and down or right and left. Play turn about—first let the man and woman each move one square—then let each of the chickens make a move, and the play continues by turns until you find out

in how many moves it is possible to drive the chickens into such a position that both of them are cornered and captured. Sketch out a diagram containing 49 corn hills and show upon it by drawing lines how you believe the chickens may be captured in the shortest possible number of moves.

A CHARADE.

My sportive first bound lightly o'er the lawn;
While my second does its owner's brow adorn;
The cheering spirit of my whole may prove,
A good Samaritan thy pains to soothe.
Cypher Ans. 8, 1, 18, 20, 19, 8, 15, 18, 14.

Why is the letter D like a sailor?
Because it follows the C.
When is a fowl's neck like a bell?
When it is wrung for dinner.
Name the richest child in the world? Rothschild.
When is a butterfly like a kiss?
When it alights on tulips.

LINCOLN'S RAIL PUZZLE

BY SAM LOYD

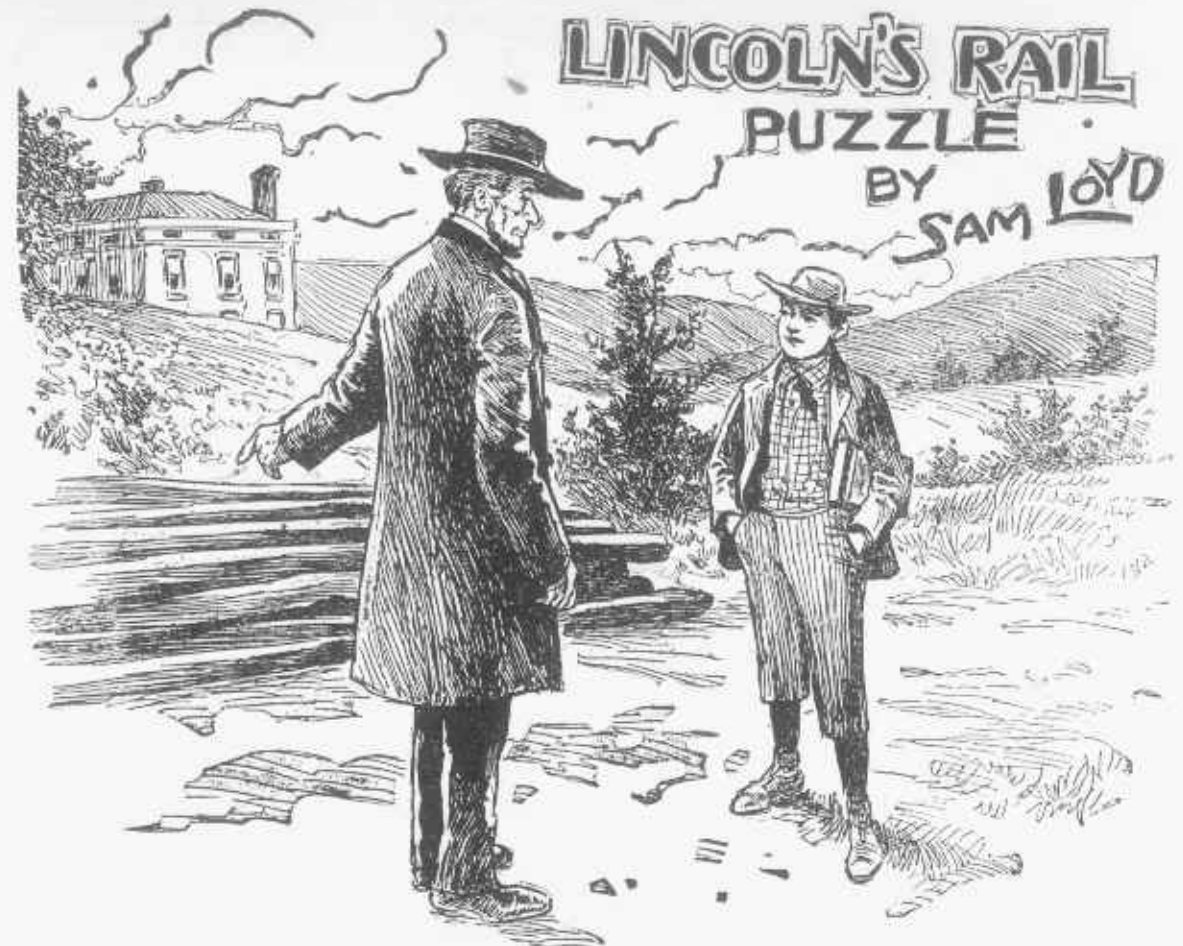

PROPOSITION—How much land can be enclosed by a dozen sixteen-foot rails?

IT WOULD REALLY appear as if there might be more in Lincoln's rail problem than appears on the surface, despite of his well known and accepted answer "that it all depends upon the length of the rail."

The pith of the proposition turns upon the shape of the land, for, despite the fact of a square being the proper shape, the nearer we get to the form of a circle the greater becomes the economy of fence in proportion to the quantity of land enclosed.

There is an instructive and interesting problem involved, which turns upon employing the shortest possible rails, when the question is to enclose an acre of land by the shortest possible length of fence. In the present problem, however, we will accept a dozen rails of the old standard length of sixteen feet, without making any reduction for lappage.

The problem is given as an elementary introduction to the principle of squaring the circle, and presents the same illustration of elusive

fractions, which makes it difficult to obtain definite and satisfactory results.

Name in two letters the destiny of all earthly things? D K.

Now and Then.

The class in concealed geography will kindly look for the locality of this illustration of the "old, old story," concealed in the description of the picture.

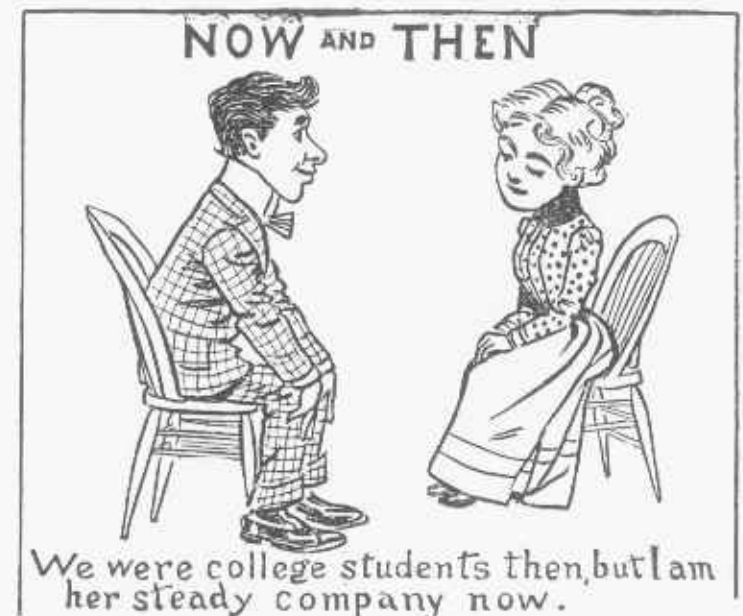



Proposition: Show how the Merchant measured the wine and water.

COURSE EVERY one is familiar with the story of the man with a barrel of honey who met a customer with a five and a three quart pitcher, who wished to purchase four quarts of honey. It is an interesting case of juggling with the measures, and is devoid of catch or quibble, and will serve to explain the accompanying puzzle, which is built upon an extension of the same principle.

A merchant of Bagdad who catered to the wants of the pilgrims who crossed the desert, was once confronted by the following perplexing problem: He was visited by the leader of a caravan, who desired to purchase a store of wine and water. Presenting three ten-gallon vessels, he asked that three gallons of wine be put in the first, three gallons of water in the second, and three of wine and three of water mixed in the third, and that three gallons of water be given to each of the thirteen camels.

As both water and wine, according to Oriental usage, are only sold in puzzle.

quantities of an even number of gallons, the merchant had only a two and a four gallon measure wherewith to perform a feat which presents some unexpected difficulties; nevertheless, without resorting to any trick or device, or expedient not pertaining to the ordinary measuring problem, as already referred to, he dispensed the water from a full hogshead, and the wine from a barrel, in the required proportions, without any waste whatever.

In how few manipulations can the feat be performed, counting every time that liquid is drawn from one receptacle to another as a manipulation? This puzzle is undoubtedly the most remarkable problem of its kind extant, and for many years baffled the puzzlists of the world to reduce to the least possible number of "moves," as the manipulations were then termed. By many it has been referred to as Sam Loyd's greatest

A WORD PUZZLE.

You first write four to equal one, Take one away and still have one; What can be spared may not be theft, So fifty take; yet naught is left.

Some Interesting Palendromes.

1. Reverse a mechanical power and have a feast.
2. Reverse a twist of thread and have music.
3. Reverse one who is diseased and have to resist.
4. Reverse a beverage and make it royal.
5. Reverse the evil one and have resided.
6. Reverse attraction and have a meadow.
7. Reverse a female name and be afflicted.
8. Reverse a male name and have done wrong.
9. Reverse a falsifier and have a banister.
10. Reverse a measure and make an opening.
11. Reverse a disposition and form a destiny.
12. Reverse a liquor and create a crime.

Answers will be found among the following words: Red rum, liar, door, Dennis, lever, Seton, leper, lager, devil, draws and doom.

GOING INTO ACTION

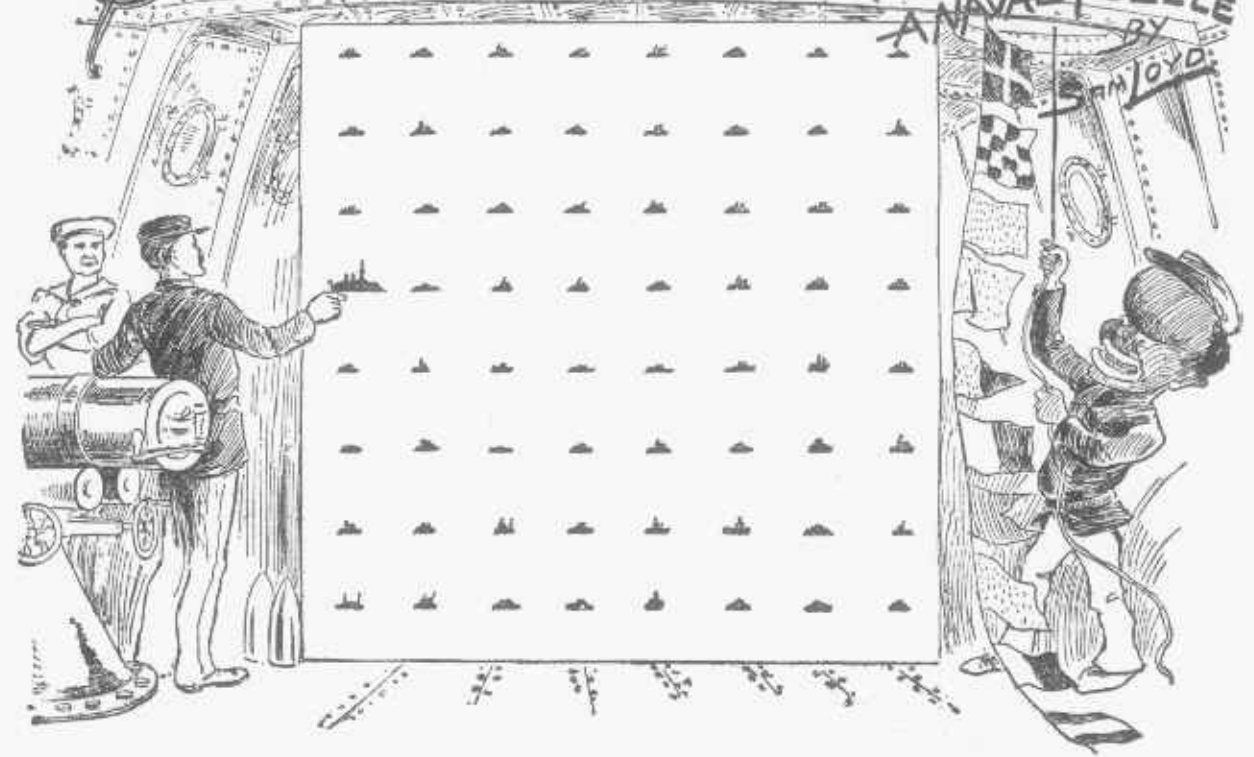

PROPOSITION—Show how the big battleship can run down the sixty-three vessels of the enemy, and return to the starting point, in the fewest possible number of straight dashes.

THE ACCOMPANYING sketch shows little Cinch running up the signal of battle, which for the benefit of such as are not familiar with the naval code of signals, will be explained to represent the once famous battle cry during the American-Spanish war, "Remember the Maine!" The commander is shown to be mapping out the plan of attack by which he designs to ram and run down the flotilla of the enemy's gunboats, so as to destroy them with the greatest possible dispatch. Commencing at the point occupied by the large battleship, mark out with one continuous line, the 63 little boats and return to starting point, after making the fewest possible number of "straight" moves, as we would term it in puzzle language.

The Break-Up of the Conundrum Club.

I have always been very partial to conundrums, and am firm in the belief that there are about thirteen million excessively stupid people, who fail to appreciate a

joke or anything that is good, who would have become more entertaining members of society if, in their younger days, they had digested conundrums. But, as I was going to say, I am no longer the president of the Conundrum Club, for the reason that the organization broke up in a row, as follows:

You see, Smith, who at heart is a capital fellow, came into the rooms one evening and says: "I've got a good one."

"What is it?" we all queried. "When is an apple pie?" He stopped, and every one looked at him expectantly, but said nothing.

"Well," finally queried a man across the room, "go on. What did you stop there for?"

"Go on? Go on with what?" he asked.

"Why, go on with your conundrum. "When is an apple pie what?"

"That's what I said," replied Smith.

"Yes, we know; but what is the conundrum?"

"When is an apple pie?"

"There is no sense in that,"

said several; "give us the rest."

"There isn't any rest," said Smith. "When is an apple pie?"

"When is an apple pie what? you gump?" yelled several from all parts of the room.

"Who said 'apple pie what?'"

"You did."

"I didn't say anything about apple pie what?"

"You did."

"I didn't; you—"

But his remarks were never concluded, as the whole assembly undertook to eject Smith, who was somewhat of an athlete, and even after the police had restored order it took several hours to explain that an apple was pie when sweetened and flavored and enclosed in crust, but there were too many sore heads to hold the club together after that fateful conundrum.

What is the difference between a cat and a comma? A cat has its claws at the end of its paws, while a comma its pause at the end of a clause.

When is a boat like a heap of snow? When it is adrift.

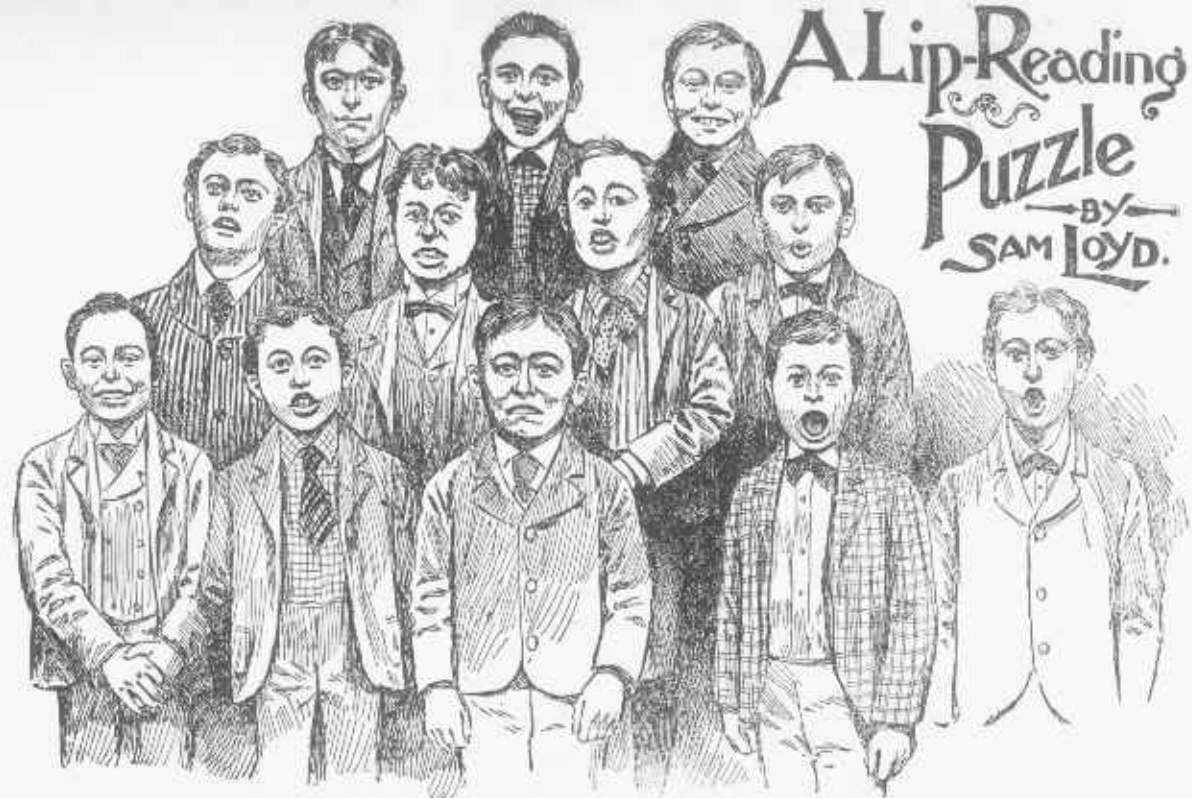

A Lip-Reading Puzzle

BY SAM LOYD.

PROPOSITION—Guess the names of the twelve boys!

SO MUCH HAS BEEN said about the wonderful powers of teaching the deaf and dumb to carry on a wordless conversation by reading or interpreting the motions of the lips, that I propose to introduce a startling puzzle, which will at first appear almost incredible.

Here is a class of a dozen boys, who, being called up to give their names were photographed by the instantaneous process just as each one was commencing to pronounce his own name.

The twelve names were Oom, Alden, Eastman, Alfred, Arthur, Luke, Fletcher, Matthew, Theodore, Richard, Shirmer and Hisswald. Now it would not seem possible to be able to give the correct name to each of the twelve boys, but if you will practice the list over to each one, you will find it not a difficult task to locate the proper name for every one of the boys. The puzzle, of course, is to guess the names of the twelve boys correctly.

Speak only two letters and thus name the destiny of all earthly things? D. K.

Why is the north pole like an illicit whisky manufactory? Because it is a secret still.

Why is a very discontented man easily satisfied? Because nothing satisfies him.

Why is a short negro like a white man? Because he is not a tall black.

What does a blind dog become in the water? Wet.

In what way do women ruin their husbands? In buy-ways.

Why is a lady embraced like a pocketbook? Because she is clasped.

Now, if you saw a peach with a bird on it, and you wished to get the peach without disturbing the bird, what would you do? Do? why—wait till he flew off.

Why is an orange different from a church bell? The orange is never peeled but once.

Why is a person bathing in the river at Paris like a madman? Because he's in Seine (insane).



"Sweet warbler, I never would harm you."

To give the young folks a chance to exercise their cleverness we present the accompanying illustration of the Birdcatcher, and ask them to discover his nationality concealed in the description of the picture.



PROPOSITION—How much does the baby weigh if the mother weighs 100 pounds more than the combined weight of the baby and dog and the dog weighs 60 per cent. less than the baby.

MRS. O'TOOLE, WHO is of an economical turn of mind, wishes to ascertain the weight of the baby, but recalling the children's trick of getting on the scales one at a time so as to get the whole party weighed for one cent, decides to ascertain her own weight as well as that of the dog. She found that she weighed 100 pounds more than the combined weight of the dog and the baby, and that the dog weighs 60 per cent. less than the baby. Our puzzlists are asked to assist the good lady in determining the weight of the little cherub which she contemplates

entering in one of the popular prize baby competitions.

It was the poet Saxe who asked:
Can you tell me why
A hypocrite's eye
Can better descry
Than you can, or I
Upon how many toes
A pussy-cat goes?
To which the clever answer is:
A man of deceit
Can best counterfeit;
So, as everything goes,
He can best count her toes!

How many sides has a pitcher?
Two, inside and outside.

What is that which no one wishes to have, yet no one wishes to lose?
A bald head.

What is the difference between a young maiden of sixteen, and an old maid of sixty? One is happy and careless, the other cappy and hairless.

Who was the fastest runner in the world? Adam. How so? Because he was first in the human race.

What one word will name the common parent of both beast and man? A-dam.

Take away one letter from me, and I murder; take away two and I probably shall die, if my whole does not save me? Kill—ill—skill.

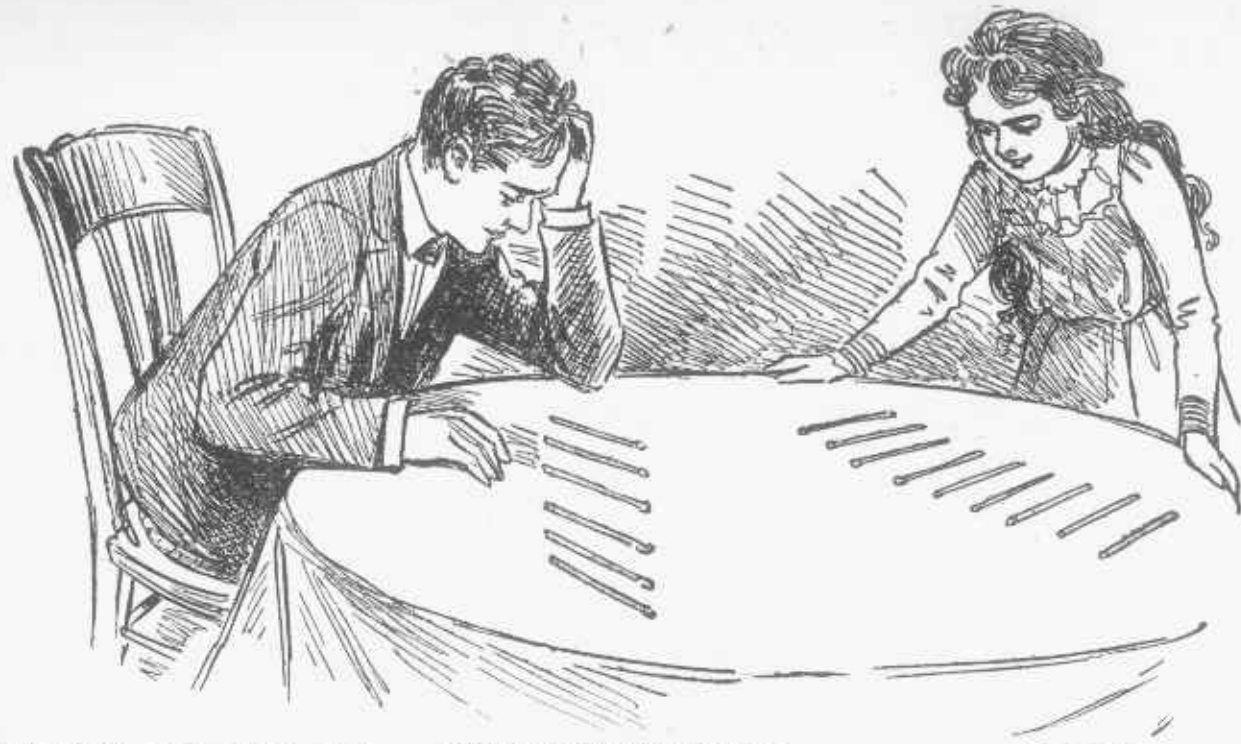

HERE is a pretty trick with matches, which will amuse the young folks who may not be familiar with the principle involved. Harry has given his sister ten matches, which he challenges her to arrange so that they will look like ten; she in turn has given him a poser in the shape of six matches, which he is to make look like nothing at all. See if you can guess these two simple tricks.

A REBUS.

My second is a useful appendage to my first, and my whole is to abridge.

Cypher Ans. 3, 21, 18, 20, 1, 9, 12.

What is the difference between a mother and a barber? The latter has razors to shave, and the former has shavers to raise.

Why is a politician like a grand piano? Because he is neither square nor upright.

What was the first bet ever made? The alphabet.

Why does it demoralize one to sit in a free seat at church? Because you get good for nothing (good-for-nothing).

What is the lightest of all garments? A shift of wind.

What is the difference between an organist and his influenza? One knows his stops, and the other stops his knows.

CONCEALED GEOGRAPHY.

54. They have nice sweet potatoes at Parker's.

55. She looked very trim in India rubber boots.

56. The Major, seizing a can of kerosene, gallantly dashed forward. (Country.)

57. Some men would lag at heaven's gate.

58. December lingering chills the lap of May."

59. Do you keep your clothes in the attic or in the cellar?

60. He ran down the street with the mob at his heels.

61. If you would make your lawns symmetrical, cut tall trees off, and lave the short ones.

62. He rode a camel bare-back through the city, to the consternation of the people. (An island.)

63. In Milan singers of note love to congregate.

64. The animal taken was all cut and bruised. (An island.)

65. A Tartar rag on a Russian flag is the Cossack signal of revolt.

66. An ape ruined my rose-bush. (Country.)

67. Was it a lynx, are you sure of it? (Country.)

68. I never sail lest I should upset.

69. Ten to one I dare do it. (Lake.)

Spell one word with the letters: "O, Stranger, I pine." (Peregrinations.)

A REBUS.

My first is found on a ship; my second is an exclamation; my third is a title, and my whole is an animal. Cypher Ans. 13, 1, 19, 20, 15, 4, 15, 14.

Why is a bald head like heaven? Because it is a bright and shining spot where there's no parting.

When is a man thinner than a lath? When he's a shaving.

If a man saw his sister fall into a well, why could he not rescue her? Because he could not be a brother and assist her too.

Why do knapsacks resemble handcuffs? Because both are made for tourists (two wrists).

When is a wall like a fish? When it is scaled.

When is a blow from a lady welcome? When she strikes you agreeably.

Why does an onion resemble a ringing bell? Because peel follows peel in an onion, and peal follows peal in a ring ng bell.

Why is a sheet of postage stamps like distant relatives? Because they are but slightly connected.

How do young ladies show their dislike to moustaches? By setting their faces against them.

Why are religious communities like bees? Because they are insects.

Why is a widower like a house in a state of di-apidation? Because he wants re-pairing.

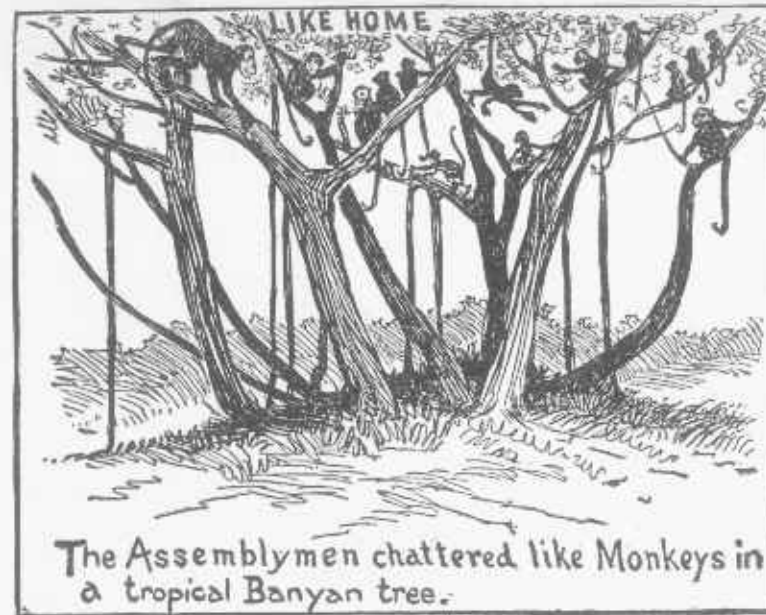

THE CLASS IN CONCEALED geography is told that when Bulle Whyo, the African prince, was shown into the State Senate, the exiled savage chieftan burst into tears, saying that "it reminded him so of his distant home."

Thinking that it, in some way, brought up painful realizations of his lost sway, he was asked for an explanation, and replied "the talking of the Assemblymen so recalls the chattering of monkeys in our banyan trees, that I am sorry I cannot shoot arrows at them."

Puzzling Charades.

A Frenchman who was studying English on the Ollendorf method became so imbued with the system that he perpetuated the following series of clever puzzles:

1. Did the butcher's monkey eat oysters on the half ladder?

No, my friend; but your two-headed uncle ate *one* on a *whole* war-horse.

2. Was the tailor's mistletoe amputated last Christmas.

Yes, madam; and his bashful *two*, *one*, underwent the severe operation of being kissed by the cobbler's *all*.

3. Were the æsthetic costumes all destroyed?

No, monsieur; *all* of them were hung in the *one* to *two*.

4. How far is it from the tailor's knee to the tailor's elbow?

The distance varies, fair damozel, but a *whole* reads that there should be a foot to the *two* of each *one*.

5. Are the French polite enough to grant woman-suffrage?

No, my sister; but the best of them believe that if *two* be not *three* to *all* he will sooner or later be reduced to *one*.

6. Is the young widow of two husbands as sensible as her sister, the miller's bride?

More so, my gentle sophomore; though she affects *all*, as when she threw the *second* after the newly wedded, she has set her *first* for the groom's-man.

7. Do toppers without thumbs drink beer through a straw?

No, your reverence; they are like *one*, each puts his *two* into the *whole*.

8. Did the ambassador eat a chicken's wing at the archbishop's banquet?

Yes, my lord; and the papal *whole two* the *one* of a turkey.

9. Did not the falling porticullis transfix the knight?

No, brave marshal of France; the *two* of the arch escaped the *one* but killed the *whole* his squire sat on.

10. Are not many of the gypsies crazy from change of scene?

One, my little one; on the contrary, there are but few of them *two*, and they are *all* called because they wander.

11. Did the lady with the eyes dark and the air sad sell all her drawings of the halfbreeds with the dark skins?

Yes, madam; and the fop with the red *one* gave her daughter so *two* a *both* of roses that he drew at the fair.

12. Was not your comrade punished from unhinging the door?

Yes, my friend; and the teacher kept me after school to *one two three* me because *two one* the yard *three* into a puddle.

13. Is not the frisky engine-tender partly blue?

Yes, great traveler, and the sleeping *one* of *two* is painted *all*.

14. Did the witches catch the venturesome *Tam*?

No, my daughter; that *one* he rode a fleet old *two*. Do not credit such idle tales. It was but the oppression of a *one two*.

15. Does the ledge-man call his horse "Magnet" because his daughter Maggie knitted the horse's fly-net?

O, no, my juvenile paragrapher; it is because he draws a *one* of *two* as easily as a *whole* could draw her needle.

16. Was the soldier drowned while fording cattle?

No, sweet corporal; he was driving a horse and *one* on the *two* of a *hill* when the *both* together exploded.

17. Was the Mill on the Floss by John H. Sullivan and Paddy Ryan what injured the morals of the village?

No, my innocent; more *all* was done when the *one* decayed with *two*.

18. Does æstheticism pay?

Yes, my Croesus of the future; it pays the dealers *one twos* and *one threes*, for the extravagance of the buyers is great as often as their taste is *all*.

19. The sailor bringeth hither fleece and peltry. Doth he not strange things to graze sheep and follow the bounding stag?

He doth not these, fond fool; and yet strange things doth he.

Prithee, master, what?

What the one windeth he drinketh; what the other bloweth he smoketh, and he danceth *both* at once.

Answers to the charades will be found in the following potpourri of words:

Dam-age, Wo-man-kind, Night-mare, In-fan-tile, Cap-rice, Load-stone, Horn-pipe, Hog's-head, Cart-ridge, Nose-gay, Pie-bald, Leg-ate, Cast-i-gate, Tom-boy, Don-key, Car-mine, Sun-dry, No-mad, Leg-end.

AN ENIGMA.

I'm just like the nose on your face,
Be it Roman, or Grecian, or pug;
By using one optic you'll notice with ease,
Just why I'm quartered so snug.

THE NEW STAR

PRIZE PUZZLE BY SAM JOYD

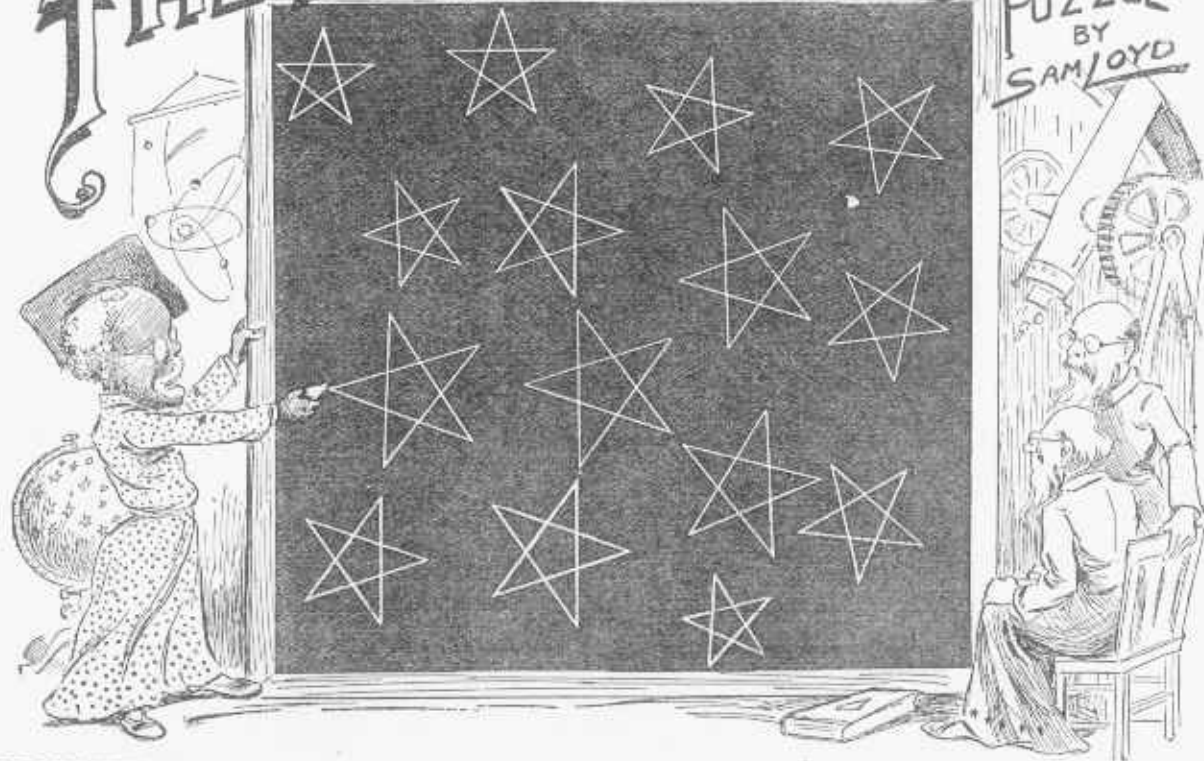

PROPOSITION—The problem is to show how and where to place another star of the first magnitude

HIS ODD PUZZLE is built upon the recent claim of a French astronomer to have located a new star of the first magnitude. He says that the popular impression held by scientists of there being no more stars is based entirely upon the discovery by a clever little puzzlist that the letters A-S-T-R-O-N-O-M-E-R-S form the pretty anagram "no more stars." We may mention that a still more appropriate anagram can be made with the same eleven letters.

The sketch shows the learned professor describing his new discovery to his brother astronomers. He has drawn the location of fifteen stars of different magnitudes, and is now going to show the position in the firmament of his new discovery.

See if you can draw the form of a five-pointed star which shall be as large as any of the others, and yet not touch one of them!

Why is O the only vowel we hear? Because all the others are in audible.

A Clever Coin Trick.

Harry and his sister are trying to solve one of those fascinating coin tricks which are so popular with the young folks. Ten coins are placed on the table as shown, so that we can count three rows of four-in-a-line, and the problem is

to discover how to change the positions of only two of the coins so that there will then be five rows of four-in-a-line. It is a very simple puzzle. Just think of it! Only move two of the coins somewhere else so as to make it possible to count five rows instead of only three!



AT THE "ZOO"

PUZZLE BY SAM JOYD



HERE IS A SIMPLE but pretty puzzle picture, full of funny figures which go to show how the unknown quantities of things may be proven by induction, without peeping under the tent or resorting to algebra.

It appears that Harry went to the circus, but being of a cautious disposition, however, Harry wished to be sure of seeing his money's worth before parting with his quarter, and therefore interrogated the doorkeeper regarding the number of horses, riders and animals.

The doorkeeper, who was really somewhat ashamed of the meagre display of wonders within the tent as compared with the glowing pictures on the posters outside, feigned ignorance of the exact number of marvelous attractions, but explained that in addition to the horses, ladies and gentlemen riders, who, with the clowns, had 100 feet and 36

heads, there was a collection of curiosities from the African jungle which would bring the sum total up to 56 heads and 156 feet!

The picture shows the character of the exhibition, but as we are dealing more with the unknown quantities of the puzzle, we will ask our young friends to tell the number of horses, riders and clowns perform-

ing in the ring in an adjoining tent, which cannot be seen at all; and also by way of a clever test of ingenuity, to tell what is the attraction in the cage to the left, which appears to be the drawing card of the show? A correct answer to this last question will prove that you were at the circus and were interested in the other features as described.



PROPOSITION—Find the weight of the turkey in troy and avoirdupois weight.



HERE IS A PRETTY problem borrowed from a Thanksgiving day transaction, which shows how Dr. Shylock was beaten at his own game. It appears that the butcher in a neighboring town received an order from the druggist for a turkey for the Thanksgiving day dinner, and in delivering the same the butcher accompanied it with the bill, and a few remarks regarding the reasonable price, which he pointed out as amounting to exactly 1 cent an ounce.

Upon the doctor's questioning the weight of the turkey the butcher challenged him to weigh it and pay according to his own scales. That was exactly what Dr. Shylock was aiming at, for he promptly weighed the turkey and showed the discomfited butcher that it weighed a certain number of ounces less than he had claimed for it.

The butcher was an honest, ingenuous sort of a fellow, so he stood by his offer to accept the other's scales, but as he wished to make some purchases from the doctor, who kept what was much in the nature of a general store, he asked, "What do you ask for rock salt?"

"Three cents a pound," replied the doctor, "weigh me as many

pounds of salt as I sold you ounces of turkey, but as I don't like your scales altogether we will weigh it over again at my place and I will pay you the difference on our bills over there."

The doctor thinking that if the scales worked in his favor the first time they should do so again, accepted the proposition and went over with his salt, but to his surprise found that the butcher's scales recorded an even number of pounds less than he had weighed at his own store.

It would appear at the first blush that very little—not to say ambiguous—data has been furnished for this problem, but after witnessing the expertness at a recent turkey raffle, where the birds were awarded to such as would guess the nearest to the correct weight, I am satisfied that our puzzlers can guess the correct weight of that turkey, which will prove to be the key to the whole situation as giving the price, as well as liberal portion of salt required to prove the veracity of this truthful story.

Why does a goose go into the water? For diver's reasons.

Why does a goose come out of the water? For sundry reasons.

Why is a stick of candy like a

race horse? Because the more you lick it the faster it goes.

When may an army be said to be totally destroyed? When its soldiers are all in quarters.

Which is swifter, heat or cold? Heat because you can catch cold.

Why is a young lady like a letter? Because if she isn't well stamped the mails (males) won't take her.

Why are dudes no longer imported into this country from England? Because a Yankee dude 'll do (Yankee doodle doo).

What flowers can be found between the nose and chin? Tulips (two lips).

Why is a dude's hat like swearing? Because it is something to avoid.

How many wives is a man lawfully entitled to by the English prayer-book? Sixteen: Four richer, four poorer, four better, four worse.

Why is a bright young lady like a spoon in a cup of tea? Because she is interesting (in tea resting).

Why does a young man think his sweetheart is like a door knob? Because she is something to adore (a door).

What is the shape of a kiss? Elliptical.

Why is a kiss like gossip? Because it goes from moush to mouth.

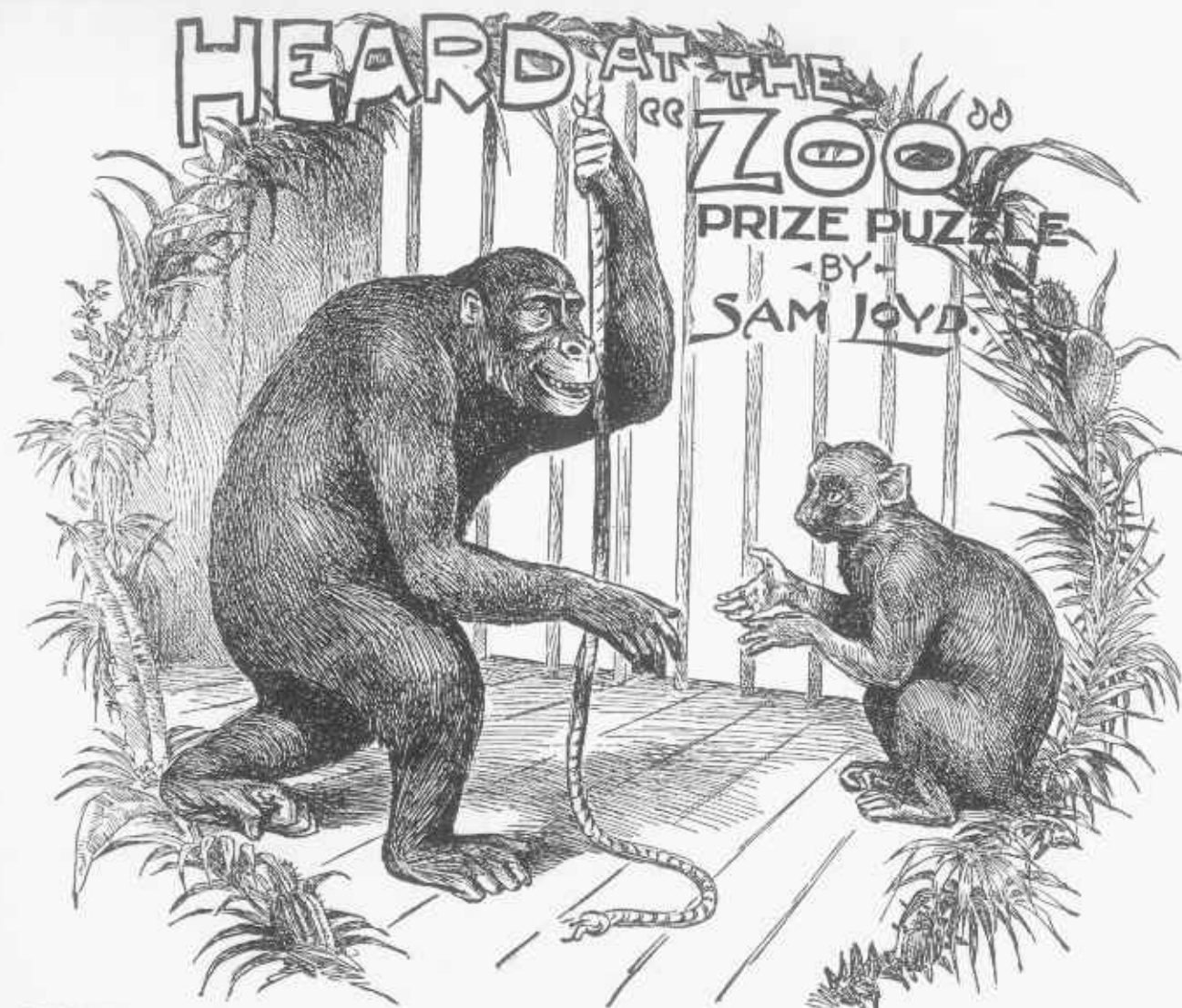

PROPOSITION—How would the year 1906 be written in the octamal system, which counts from 1 to 8, with the 9 and 10 eliminated?



AS SHOWING HOW difficult it is for the average person to leave the beaten track when thinking out some simple problem, let us take a look at the system of numeration with which we are all familiar. It is safe to say that most people have never given a thought to the subject beyond a knowledge of the self-evident fact that if 7, 20 and 100 are added together it becomes 127, which being analyzed, reads, one hundred, two tens and seven units. They see that any column can be built up to 9, but that as soon as it gets above 9, it is carried over to the column to the left. They think it is so because it must be so, and can't help itself any more than 1 and 2 can help being 3. Primitive man originally learned to calculate upon the fingers of both hands, just

as we see many people to-day utilizing their fingers in the illustration of some every-day transaction. Hence the introduction of the decimal system. If the human race, as has been claimed, sprang from the Angwarribo family of monkeys, who have but four fingers, and we had not taken on that extra finger, we would have continued to calculate in what is known as the octamal system.

From a mathematical standpoint, it can be shown that the decimal system is not so perfect as some of the others, and that for some purposes the septamal, which only runs up to 7, is better. In that notation 66 would mean 6 sevens and six units, so the addition of 1 more would change it to 100, which would be equal to only 49 in the decimal notation.

You see 1 added to the 6 in the

unit column would change it to 7, so we would have to place an 0 and carry 1 on to the other 6 which in turn becomes a 7, so we place another 0 and carry the 1 to the third column, making it 100, which stands for 49. In this same way 222 represents two units, two sevens and two 49's=114.

Assuming the octamal system to be the popular notation in the Angwarribo days of our four-fingered ancestors, when they counted up to eight, and knew nothing about 9's or 10's, how would you write down the year 1906 so as to show the number of years which have elapsed since the Christian era? It is a pretty problem which will clear the cobwebs from the brain, and make one familiar with the principle of numbers.

CHRISTIANS AND TURKS



PROPOSITION—Find a number which, by counting round and round, will pick out all the boys.



ALL PUZZLISTS ARE familiar with the ancient story of thirty Christians and Turks at sea in a storm, and how the captain decided that one-half of his passengers would have to be thrown overboard to save the ship. Being a fair-minded man who believed that all should be treated impartially, he arranged them in a circle and agreed to count off every thirteenth man until fifteen unfortunate mortals had been selected. As the story goes, one of the Christians was a mathematician and a devout man who believed that Divine Providence had sent him to save the faithful and destroy the unbelievers. Therefore he arranged the thirty passengers in such a manner that the thirteenth man, as the counting out proceeded, invariably proved to be a Turk.

That puzzle, as you doubtless remember, turns upon arranging let us say fifteen white counters and fifteen black in a circle, so that by counting round and round and taking away every thirteenth one, that all of the blacks will be re-

moved. To solve the puzzle you need merely place thirty counters in a circle and begin to count around picking off every thirteenth until fifteen have been removed. Then replace the vacant spaces with black men and let the other fifteen be white and it shows how the Christians and Turks must have been arranged.

The above story is related by way of introduction to tell how it chanced one day that ten children, five girls and five boys, returning from school, found five pennies. A little girl found the money, but Tommy Muttenhead claimed that as they were all together the "find" really belonged to the crowd. He had been told the "Christians and Turk" story, and thought it would be a great scheme to play it as a game in dividing up the pennies, it being clear that there were only enough to go half way around. He placed the children in a circle, as shown in the picture, and told the girls that they were the "Christians" and the boys the "Turks." Tommy had planned it all right, so that by counting thirteen from a circle point

the girls would all be counted out, but he forgot that each girl got a penny as she was counted out, so the boys were left, and all that Tommy got was a good licking which the boys gave him in a lot back of the school. Now this puzzle differs from the old Christians and Turks problem, because you are to guess the proper starting point, as well as the smallest number which will count out the boys and leave the girls.

Commencing with the upper girl without a hat and counting around to the right, every thirteenth will be a girl; but the puzzle is to tell what number Tommie should have used in place of 13 to give the prizes to the boys.

Of course, as each one is counted out, he is supposed to step back from the circle and is omitted in the next counting, which commences from the next one.



Red Cross Volunteers

A PRIZE PUZZLE
BY
SAM LOYD

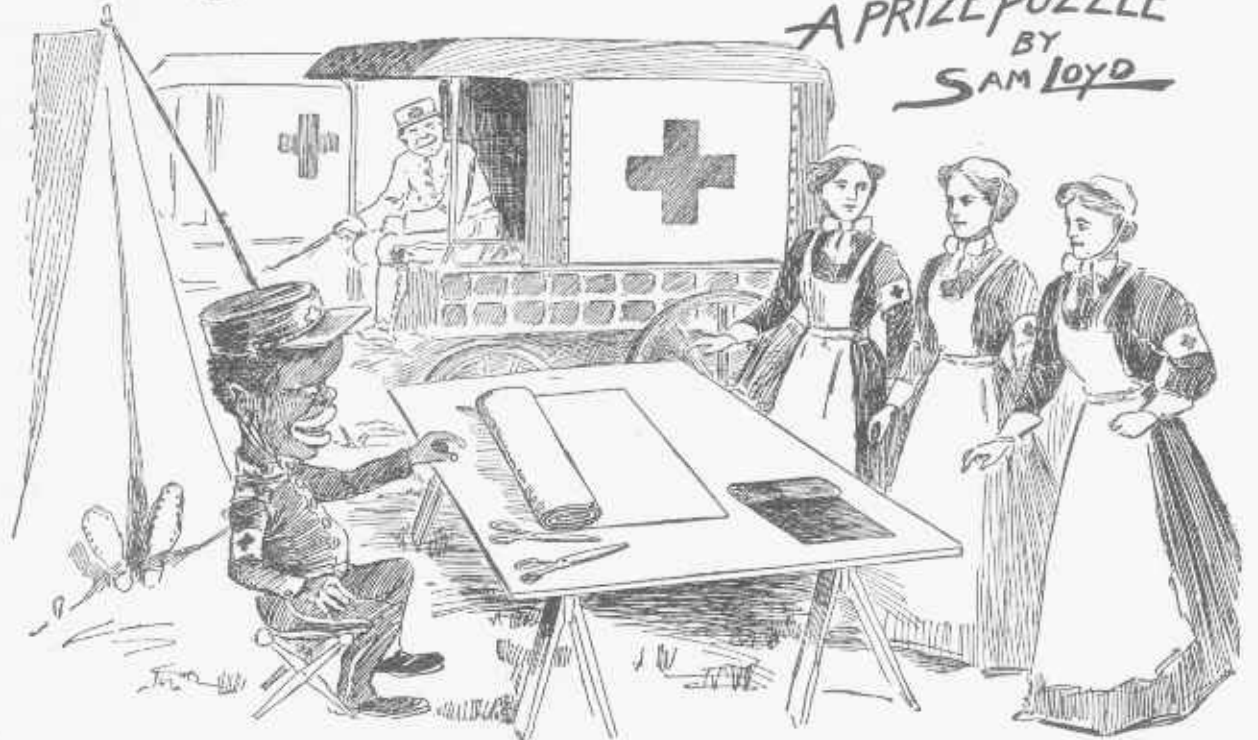

PROPOSITION—Cut a square piece of paper into five pieces which will make two Greek crosses.



HERE IS A PRETTY little cutting puzzle, which is said to have originated in the mind of a Red Cross lassie while serving in Uncle Sam's Aid balance Corps. It is safe to say that the bright witted little volunteer must have been a lineal descendant of Betsy Ross, who, it will be remembered designed the five-pointed star with one deft clip of her scissors. In the present instance it was necessary to practice strict economy in the manufacture of the red crosses to decorate the arms of the nurses, for the reason that the supply of red flannel was running very short in camp, so the problem presented is as follows: Take a square piece of paper and without any waste cut it into five pieces which will fit together so as to make two Greek crosses of same size.

Progressive Conundrums.

"Miss Gracie," he said, with an engaging smile, "did you ever try your hand at one of these progressive conundrums?"

"What is a progressive conun-

drum, Mr. Spoonamore?" inquired the young lady.

"Haven't you heard of them? Here is one: Why is a ball of yarn like the letter 't'?" Because a ball of yarn is circular, a circular is a sheet, a sheet is flat, a flat is \$50 a month, \$50 a month is dear, a deer is swift, a swift is a swallow, a swallow is a taste, a taste is an inclination, an inclination is an angle, an angle is a point, a point is an object aimed at, an object aimed at is a target, a target is a mark, a mark is an impression, an impression is a stamp, a stamp is a thing stuck on, a thing stuck on is a young man in love, and a young man in love is like the letter 't' because he stands before 'u,' Miss Gracie."

"I don't think you have the answer quite right," said the young lady. "A ball of yarn is round, a round is a steak, a stake is a wooden thing, a wooden thing is a young man in love, and a young man in love is like the letter 't' because, Mr. Spoonamore"—and she spoke clearly—"because he is often crossed."

The young man understood.

He took his hat and his progres-

sive conundrums and vanished from Miss Gracie Garlinghouse's alphabet for ever.

RIDING AGAINST THE WIND



Here is a pretty mathematical problem which will interest the school children, as well as some of the teachers, for the reason that the popular answer is quite incorrect as the principle involved is not generally understood.

A bicycle rider went a mile in three minutes with the wind, and returned in four minutes against the wind. How fast could he ride a mile if there was no wind?

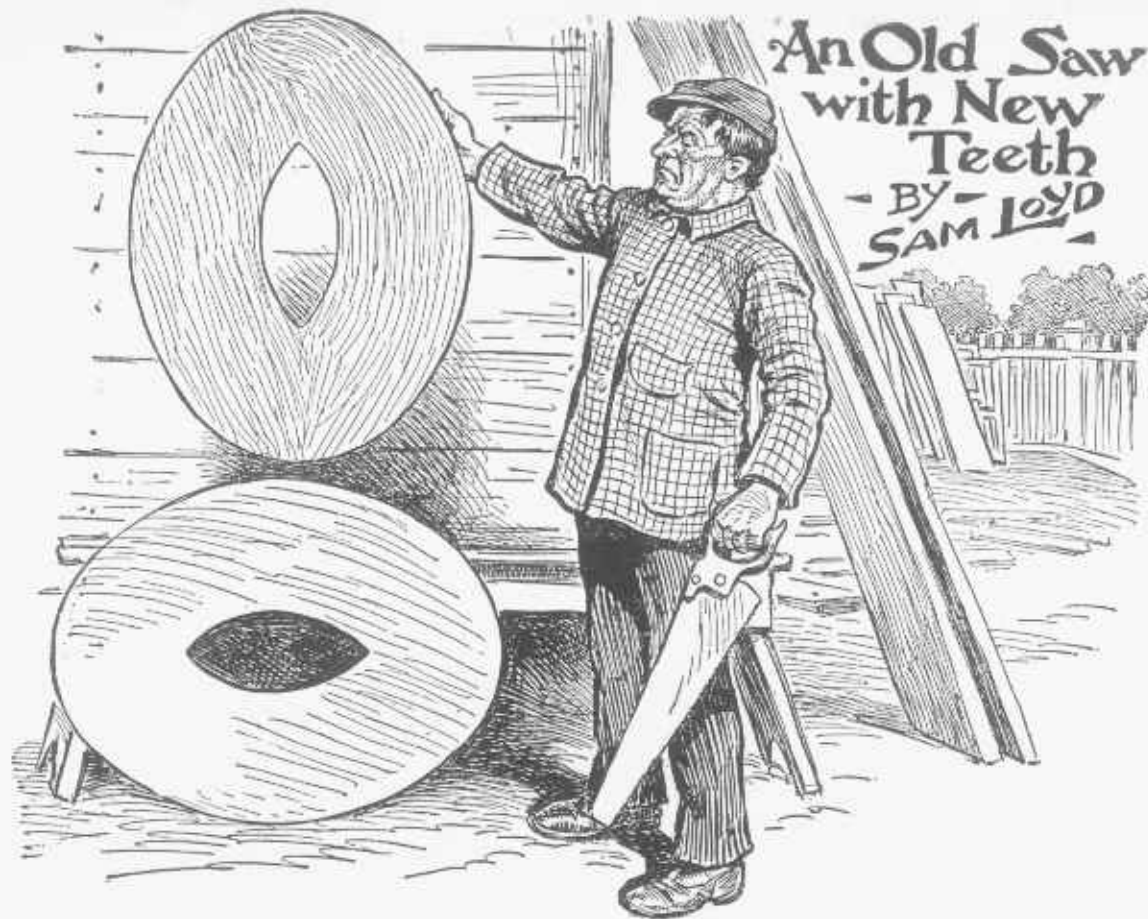

PROPOSITION—Divide the two ovals into the fewest possible number of pieces which will fit together and form one large circular piece.



ALMOST EVERY COLLECTION of puzzles contains a certain problem wherein it is told how a joiner who had a circular board wished to convert it into two oval table tops, with holes in the centers as shown. The puzzle is to cut the circular piece into the fewest number of pieces which will form the two ovals, but as the shape of the ovals are not given, the puzzle is generally looked upon as too difficult and unsatisfactory.

By the modern plan, however, which is to reverse a problem and work it backwards, the terms may be turned around so as to make a presentable, up-to-date puzzle, and is given as an instructive lesson in puzzle building.

Divide the two oval rings into the fewest possible number of pieces which will fit together and form one circular piece—like the top of a table without any hole in it.

Of course, you may follow the old style if you prefer it. Take a perfect circle and divide it into the fewest possible number of pieces

which will fit together and form two oval rings as shown, but remember to put a strong accent upon the "fewest" number of pieces.

A Good Catch on Sharpe.

Brown (to Sharpe, who prides himself on his spelling): "I bet I can give you a word you can't spell."

Sharpe (scornfully): "I bet you can't."

Brown: "Very well. How do you spell 'need,' meaning to need bread?"

Sharpe: "Poof! K-n-e-a-d, of course."

Brown: "Wrong."

Sharpe: "Wrong? Meaning to knead bread, you said, didn't you?"

Brown: "Yes."

Sharpe: "Well, it's k-n-e-a-d, I tell you."

Brown: "Not at all. You k-n-e-a-d dough, but you n-e-e-d bread. It's a simple word; sorry you couldn't spell it."

Why are ripe potatoes in the ground like thieves? Because they should be taken up.

What is that which everyone wishes, and yet wants to get rid of as soon as it is obtained? A good appetite.

When is an old lady like a trout? When she takes a fly that brings her to the bank.

What is it gives a cold, cures a cold, and pays the doctor's bill? A draft.

Take away my first letter, I remain unchanged; take away my second letter, there is no apparent alteration in me; take away all my letters and I still continue unchanged? The postman!

Why is a new-born baby like a storm? Because it begins with a squall.

Mention the name of an object which has two heads, one tail, four legs on one side and two on the other? A lady on horseback.

Why is a four-quart jug like a lady's side-saddle? Because it holds a gall-on.

If you were kissing a young lady, what would be her opinion of newspapers? She wouldn't want any Spectators, nor Observers, but plenty of Times.

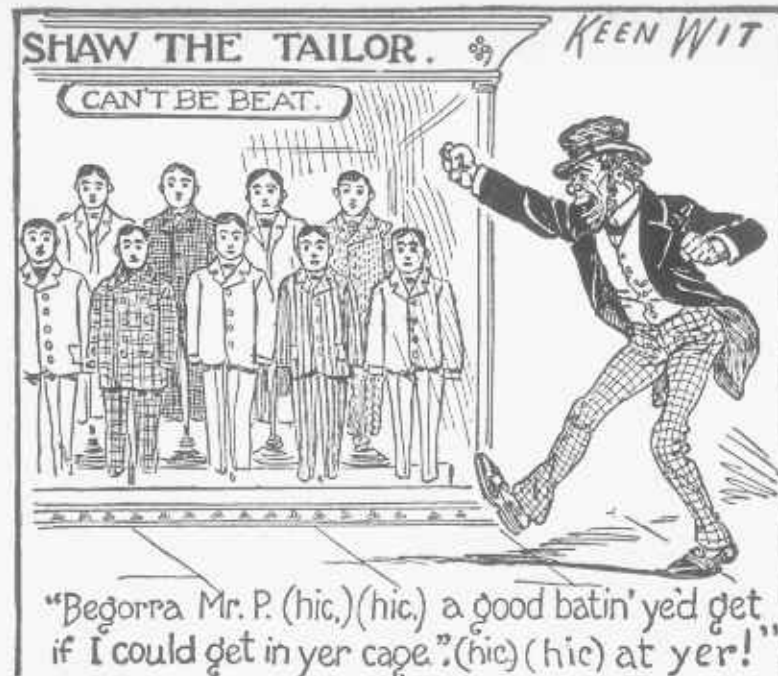

TO TEST THE WIT and cleverness of our young folks in the mastery of the following study in concealed geography, wherein the locality of the incident is hidden in the description of the picture, we will take occasion to gauge their sense of humor by asking each one to also express an opinion regarding the full meaning of the Jolly Hibernian's sarcastic remark.

A REBUS.

My first is a negative greatly in use, Which people first say when they mean to refuse;
My second we'll call a measure of weight,
Frequently used when talking of freight.
An article always in use is my whole,
With texture and form under fashion's control;
A something that's needed all over the earth,
Yet often is quoted a thing of small worth.
Cypher Ans. 2, 21, 20, 20, 15, 14.

Behold a crime and leave common sense? T-reason.

What snuff-taker is that whose box gets fuller the more pinches he takes? The snuffers!

Why have miserly people never quarreled? Because they have always agreed.

Why are people of short memories necessarily covetous? Because they're always for-getting something.

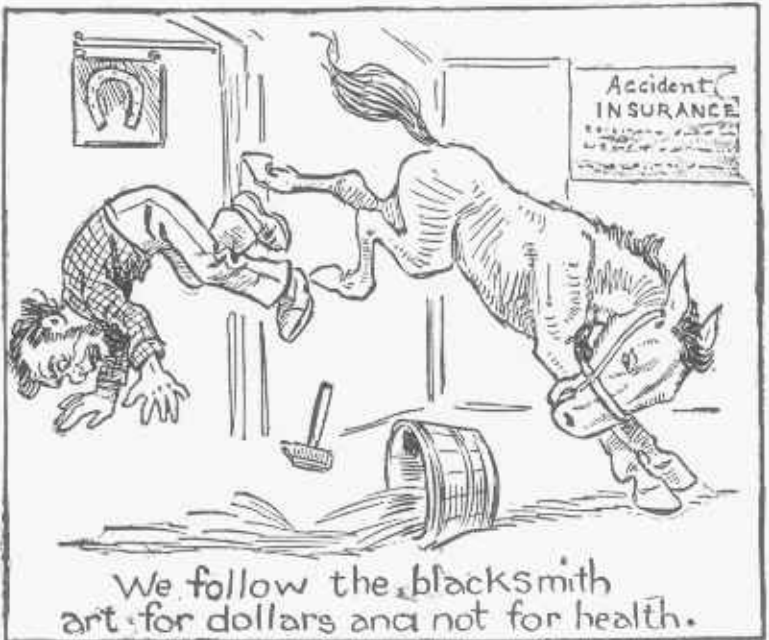

the horse endowing the cautious smith with a weekly annuity of \$50 for a fractured collar bone and sundry bruises, which will not heal for years. The puzzle, however, is to discover the concealed locality of the incident.

AN OLD STYLE ENIGMA.

I am composed of twelve letters.
My 2, 8, 9, is dug out of the earth
My 6, 11, 12, 8, is a numeral.
My 4, 2, 3, is an instrument of war.
My 12, 8, 1, is a vessel used in former times.
My 5 is a vowel.
My 4, 7, 1, 9, is a hard substance.
My 10, 9, is a pronoun.
My hole is now before you.

A REBUS.

My tongue is long, my breath is strong,
And yet I breed no strife.
My voice you hear both far and near,
And yet I have no life.
Cypher Ans. 2, 5, 12, 12.

Why should the number 288 never be mentioned in refined company? Because it is two gross.

What letters of the alphabet are most like a Roman emperors? The C's are.

What is the breed of the dog-star? A sky-terrier.

When may a man be said to be literally immersed in business? When he's giving a swimming lesson.

When giving invitations to a dancing party what single word will tell the hour to begin dancing? At ten-dance (attendance).



PROPOSITION—Tell why the heart of the apple tree is like the tail of the dog.

SHOWING HOW puzzle ideas may be gleaned under the most adverse circumstances, I should take occasion to give a little conundrum which occurred to me during the last summer's outing.

It was during a tramp with a chum of mine that, spying an orchard of fine apples which belonged to a friend of mine who would have been offended if we had failed to compliment him by showing our appreciation of his rare species of fruit, we proceeded to gather some luscious specimens, but were disturbed by the advent of a very boisterous bulldog.

Not to interfere with his gambols or any proprietary rights he might claim, we ascended into the lower branches of one of the trees to bide our time until the dog, getting tired of making a noise and springing in the air, would go home. But bulldogs have no sense of time, so it was not until after midnight, when it was too dark for him to see us, that he concluded to change his field of usefulness; but I am sure that for more than ten hours he furnished such interesting food for conversation that neither of us thought of going home. He was such a cunning dog that we did not wish to harm him, although Jack said if he did not believe he was a very valuable dog, or possibly belonged to some poor family who could not afford to lose him, he would have gone down, taken him by the tail

and dashed his brains out against a tree.

Jack said a great many good things, but one of the best which I now remember was a challenge to tell why the heart of that apple tree

was like the tail of the dog? I am going to offer prizes for the best answers to Jack's conundrum, and have made a correct sketch of the situation, the remarkable point of the puzzle being that you are to describe the resemblance of two objects which you cannot see in the picture.

THE SANTOS-DUMONT PUZZLE.

Just to correct a popular mistake regarding the calculation of the time required to ride or sail with and against the wind, I will present a little balloon puzzle to illustrate an error which crept into the record of Santos-Dumont's famous trip around the Eiffel Tower.

Suppose that a balloon propelled by some mechanical device travels five miles in ten minutes with the wind, but requires one hour to go back again to the starting point against the wind, how long would it have taken to go the whole ten miles in a calm, without any wind? This, as a matter of fact, is but another way of treating the discussion as to how far the balloon actually should be credited with going in one hour and ten minutes.

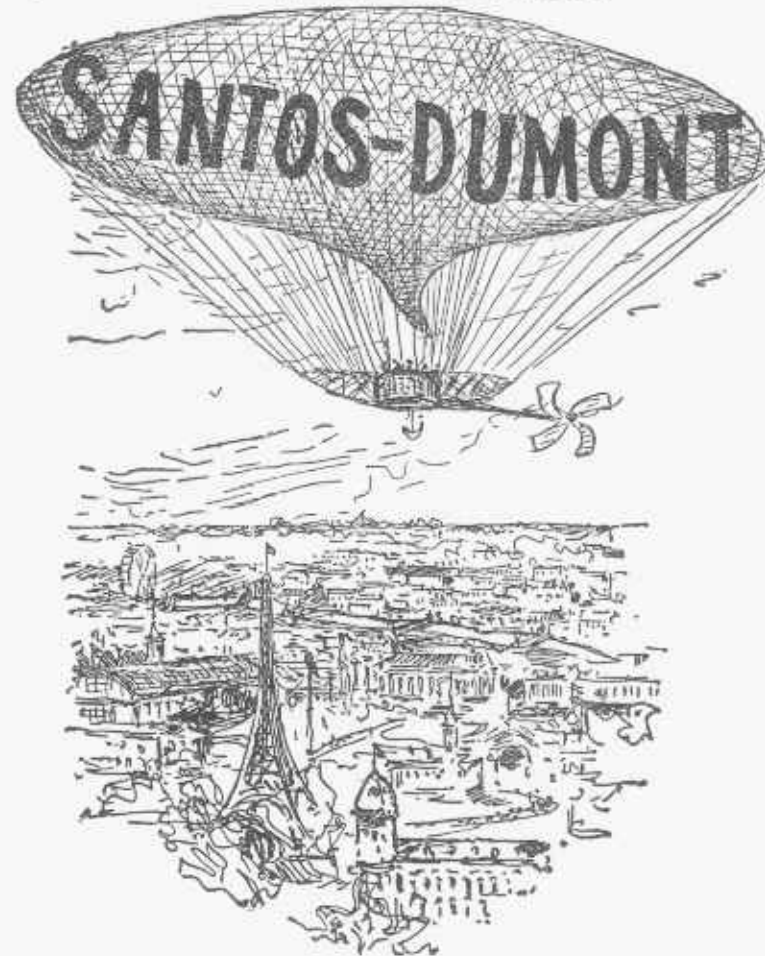

Railroad Lingo.



PEAKING ABOUT A little experience of my own, I wish to say that Mandy and me come to town last week to see the boy, and we wuz wonderfully struck by the lingo an' ways of them conductor men on our branch of the P. D. Q. Railroad. A feller was tryin' to git a free ride by sayin' he wuz a member of the Brotherhood of Engineers, and the conductor man jist axed him what time it wuz, an' when he says, "a quarter to one," the way the conductor man threw him off of the train into a swamp wuz a caution. "Fur," sez he, "any railroad man who duzent know nuff to say 'twelve-forty-five' should stay in the swamp."

Mandy axed him how long we would stop at Kechunk, an' he says, "jist four minits, 2222222 lunch!"

We didn't know much what he meant, but sooner than be chucked out in a swamp we kept our ignorance to ourselves, and just smole them smiles you see in our pictures, but I hev been thinkin' it over some, and believe I know what that conductor man meant by making an engine of himself when he went: "Chew, chew, chew, chew, chew, chew!" So I ask our puzzlists to try and guess it.

A Hat Puzzle.

Take the average business man away from his ledger, by introducing some little proposition which does not readily balance between debt and credit sides of his cranium, and you will appreciate the meaning of that time-honored adage about the difficulty of teaching an old dog new tricks.

The truth of this statement was illustrated the other day by a well-known man about town in the following words, well worth repeating:

"You see I had just won a \$5 hat on Jeffries, and through the medium of that wager I settled a rather complicated piece of indebtedness. Some two weeks before, I had been playing a little game of hearts with three friends, a retail merchant, an insurance man and a drummer. When we got through the merchant had won \$5 from the insurance man and I had lost a similar amount to the drummer. Meanwhile the insurance man had stuck the drummer for \$5 himself. The winnings and losings were all represented in chips, and as none of us had any money, outside a little small change, we simply made a memorandum of the matter and agreed to settle up the next time we got together. On the night of the prize fight I won a \$5 hat and

my victim gave me an order, good anywhere in town. I had enough hats already to do me for the season, so next morning I dropped around to my friend the merchant and give him the order. 'Send around and get \$5 on this,' I said, 'and consider all those heart games accounts wiped out.' 'Why, you don't owe me anything,' says he. 'But I owe Billy \$5,' I replied, 'and I'll consider that settled.' 'But Billy owes me nothing, either,' he protested; 'I won all my money from Bob!' I tried to make the thing clear to him, but I couldn't. The more he figured on it the worse tangled up he got, and finally he refused to take the order. Then I went around to Bob, the insurance man, thinking that he had a good head for figures and would see through it at once, but I overestimated him. 'What kind of a bunco game is this, anyhow?' he asked; 'the way you calculate it would put me \$5 in debt to you and Billy.' 'Holy Moses!' said I, 'you've got a head as thick as a man-o-war's coning tower!' and I started all over again with my explanation. He couldn't grasp it. 'Too many for me,' he said, and I quit him in disgust and hunted up Billy. As soon as he heard the proposition he brightened up. 'What is the catch to it?' he asked, eagerly; 'that would be a splendid gag for me to get off on the road.' 'Catch your grandmother! you mutton-headed idiot!' I roared. 'There's no catch at all. It's a plain, simple matter of business!' With that I sat down and wrote out a statement for each, and after several days' studying the matter reluctantly accepted the order. All three of them still think that I've swindled them in some mysterious manner."

How few people there are who would read that story as told, and grasp the whole situation without resorting to pencil and paper?

Which are the lightest men, Scotch, Irish, or Englishmen? Englishmen. In Scotland there are men of Ayr; in Ireland men of Cork, but in England are lightermen.

Why should an artist never be short of cash? If he knows his business he can always draw money.

Why is a prudent man like a pin? Because his head prevents him from going too far.

When you listen to a drum why are you a good judge? Because you hear both sides.

DIVIDING HIS FLOCKS BY SAM LOYD

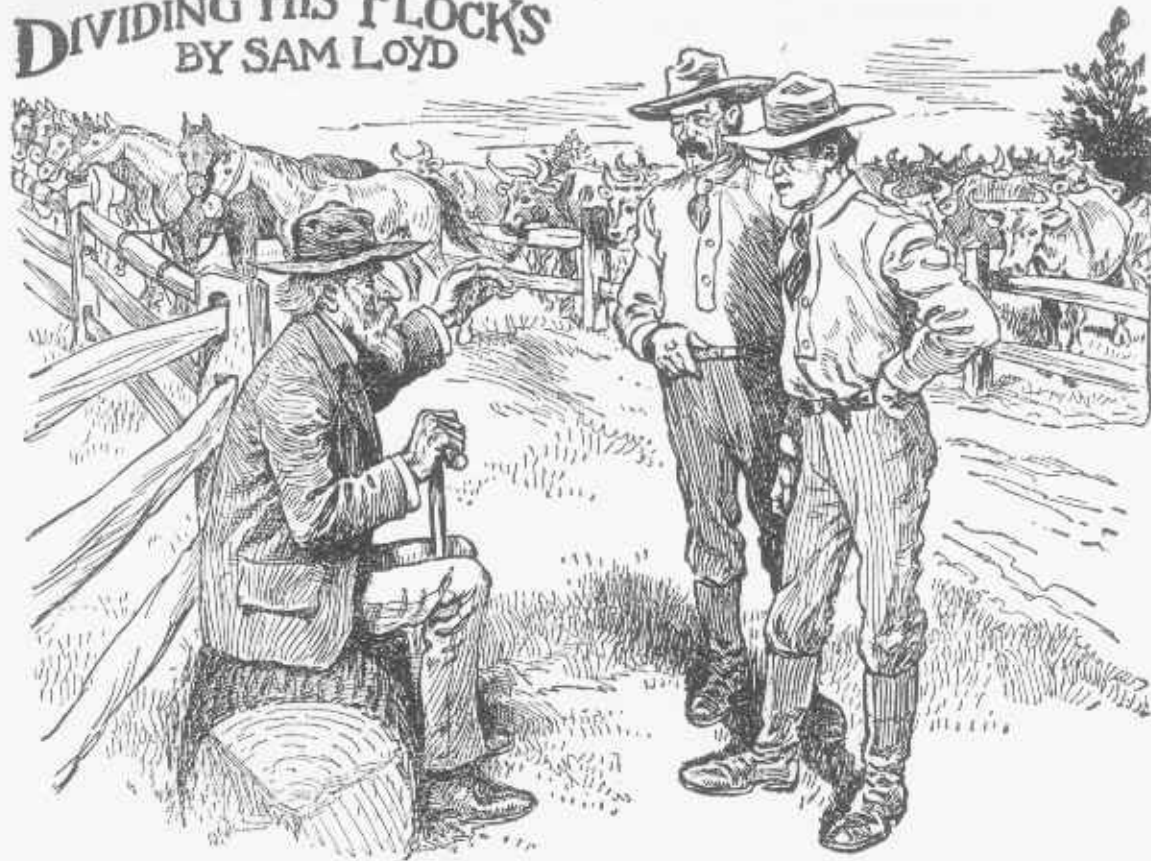

PROPOSITION—Discover the number of sons there were and how the horses and cows were divided.

THE STORY IS TOLD of a Western ranchman who, finding himself well advanced in years, called his boys together and told them that he wished to divide his herds between them while he yet lived. "Now, John," he said to the eldest, "you may take as many cows as you think you could conveniently care for, and your wife Nancy may have one-ninth of all there are left."

To the second son he said: "Sam, you may take one more than John took, as he had first pick, and to your good wife, Sally, I will give also one-ninth of what will be left."

To the next younger he did the same, giving him one cow more than Sam's portion on account of the better cows having been picked first, and to his wife one-ninth of the remainder. This he continued to do until the herd of cows was divided. Then he said: "As horses are worth twice as much as cows, we will divide the horses that every family receive live stock of the same value."

Now, if our young farmers will

just exercise their wits and tell how the cows and horses were portioned out to the families, I would be delighted to distribute such horses and cows as I possess, for despite of its being extremely simple it calls for ingenuity rather than mathematical knowledge.

The Lucky Boys.



Here are the lucky boys once more, explaining to those who are up in Uncle Sam's coinage some mysterious problems which go to prove how much better it is to be

lucky than YY. You see, they had been on an all-day fishing excursion, and meeting with their usual success, had caught such a big string of fish that they sold them for \$3.90. Just think of it—\$3.90 represented by seven coins. And that was the most remarkable part of this fish story, for although \$3.90 is readily divisible by three, yet the seven coins were such as would not make three even portions. They puzzled their heads over the problem, and were getting very angry, when one of them, the youngest, suggested that sooner than come to blows over such a trifle, they had better throw one of the coins away, and then they could readily divide the rest evenly. So they just threw the troublesome coin down an old well (where the little fellow, who knew there was no water in it, got the coin again the next morning), and by dividing the remainder equally among the three successful fishermen avoided a serious quarrel.

How many of our friends can prove the value of that coin which the foxy little chap advised them to throw into the well?

ARCHIMEDES

AND THE CROWN

CLASSICAL
PROBLEM

BY
SAM LOYD



IT IS SOMEWHAT strange that in the story of Hiero, King of Sicily, who gave his crown to Archimedes to determine the amount of alloy which had been added to the gold, all accounts give the same version; agree in the minute details of the given weights, and yet I have never seen the problem worked out to show just how much gold the dishonest jeweler had stolen.

It is told that Hiero, the King of Sicily, ordered his jeweler to make him a crown containing sixty-three ounces of gold. When the crown was finished it was found to be correct in weight, but the King, for some reason or other, always suspected the jeweler of having stolen part of the gold and substituted silver.

In this enlightened age, when you go to an assayer to sell some piece of broken-down jewelry, he tests the proportion of gold contained in the piece by rubbing it upon a test stone, which leaves a fine streak of gold. Some acid is then applied and the time is reckoned to determine how long it takes the acid to destroy the gold, as the metal will resist the acid

in proportion to the purity of the gold.

They probably had no such tests in those days, as we are told that the King, as well as the philosopher Archimedes, was troubled for a long time to discover a method of solving the problem. There seems to be a difference of opinion as to who should be credited with the honor of hitting upon the happy thought which suggested the solution to the mystery. It is said that the King was taking a bath, and noticing that the crown weighed less in the water than in the air, gave vent to his joy by the memorable shout of "Eureka!" which has been echoing ever since.

Well, the authentic facts of the case were as follows: The crown weighed exactly sixty-three ounces, and when weighed in the water gave a weight which showed that it had removed just 8.2245 cubic inches of water.

It was found that a cubic inch of gold carefully tested weighs exactly 10.36 ounces, and that a cubic inch of silver but 5.85 ounces. Therefore it becomes a simple calculation to determine the quality of the alloy for 8.2245 inches of pure gold should weigh over eighty-five ounces,

whereas the crown weighed but sixty-three. Supposing it to be all silver, the 8.2245 cubic inches at 5.85 would weigh but a little over forty ounces, which would be some thirteen ounces short.

With these facts before us, it becomes a simple matter to make even a close guess as to the amount of the jeweler's speculation, and if we assume that an ounce of pure gold is worth \$21, and an ounce of silver to be valued at sixty-one cents, we can determine the exact amount over which there has been so much fuss made for all of these centuries.

Archimedes was the greatest mathematician and philosopher of his time; he it was who, during the siege of Troy, destroyed the enemy's fleet by means of reflecting mirrors. He invented many mechanical powers and boasted to King Hiero that he could move the world if he could only have a point on which to rest a lever. The reason why the answer to this crown problem is never given may be accounted for by his strange death.

In my first my second sat, my third and fourth I ate? In-sat-i-ate.

SAM LOYD'S Hod Carrier's Problem

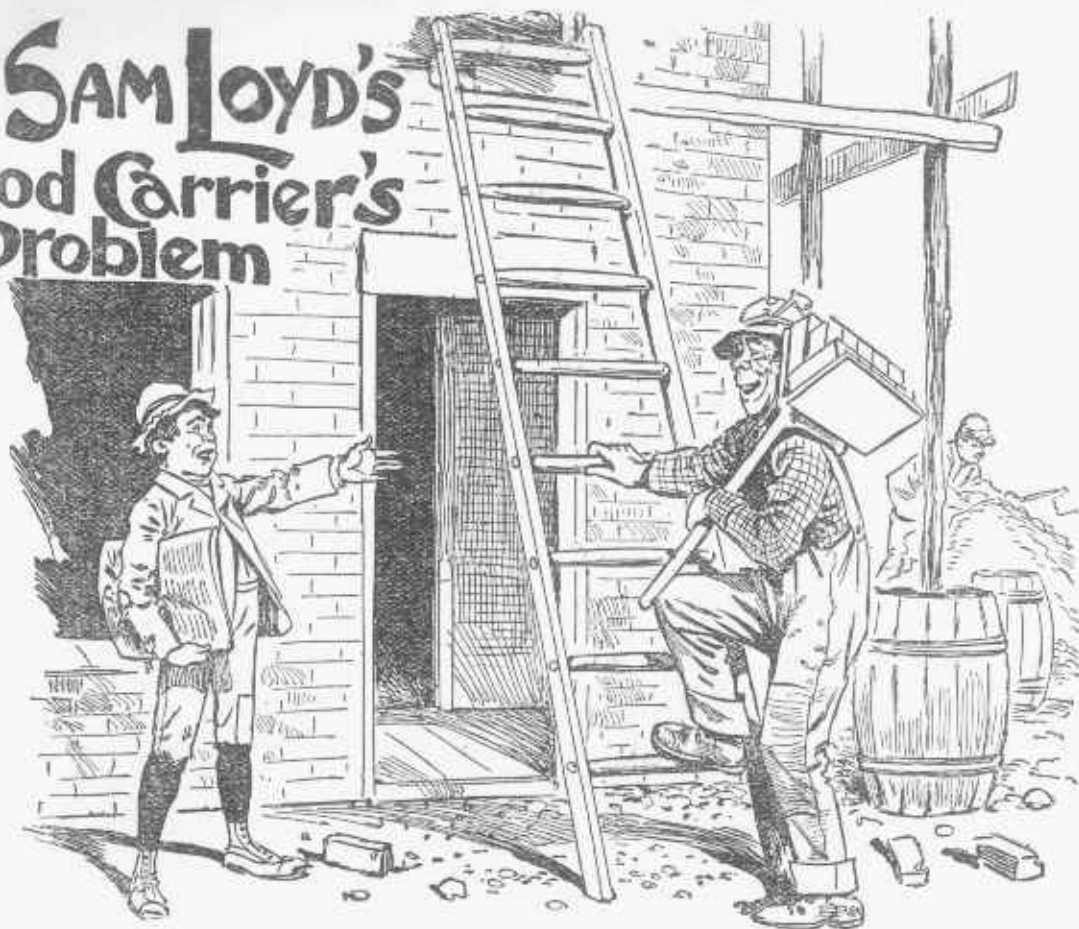

PROPOSITION—Tell how few steps need be taken on the ladder to go up and down and up to the top, stepping twice on every step.

SCHOOLBOY, WHO was one of those smart Aecs who think that they know it all, was quizzing a hod carrier about the weight of a brick, if a brick weighs three-quarters of a pound and three-quarters of a brick and three-quarters of a pound, when the man retorted by saying: "Now, every one should stick to his trade; you are up on figures and I am up on the ladder, so I will agree to guess your puzzle if you will tell me the correct answer to mine. Just figure out the fewest number of steps one has to take to go up and down and up this ladder, so as to be twice on the ground and twice on the top.

Every step must be of the same height and all of the steps must be used the same number of times?"

There is no catch or pun about this puzzle. It is straight goods, and yet it is safe to say that our young folks will have to go up and down that ladder many times before they hit upon the correct answer.

Words, Empty Words.

The following lines do not pertain to the world of puzzledom, in the accepted meaning of the term, and yet they would baffle the average puzzlist to get at their meaning, if any there be. The verses were given to a young man of literary aspirations, with instructions to convert the same into prose in such a way as to preserve the exact spirit and meaning of the poet, whose works had been enthusiastically lauded by his friends. As the descriptive name of the poem has been lost it would be difficult to suggest an appropriate one, so it has to be omitted:

See! the fragrant twilight whispers
O'er the orient western sky,
While Aurora's verdant vespers
Tell her evening's reign is nigh.

Now a louder ray of darkness
Carols o'er the effulgent scene,
And the lurid light falls markless
On the horizon's scattered screen

Night is near, with all its horrors,
Sweetly swerving in his breast,
And the ear of fancy borrows
Morning mists to lull the west.

Ere he comes in all his splendor,
Hark! the milky way is seen,
Sighing like a maiden tender
In her bower of ruby green.

Such a scene, ah! who can list to,
And not saddened, silent, seek
To unveil the burning vista
Of Diana's raven cheek?

Thus tremulous, and ever dear,
Robed in repellant splendor,
Lingering moments, swift as the year,
Illumed by Cupid's capture!

And when hymenal joys are ours,
And memory soars above us,
Hope shall trace for future years
The love of all who love us.

What tree is of the greatest importance in history? The date.

When is a lady's arm not a lady's arm? When it is a little bare (bear).

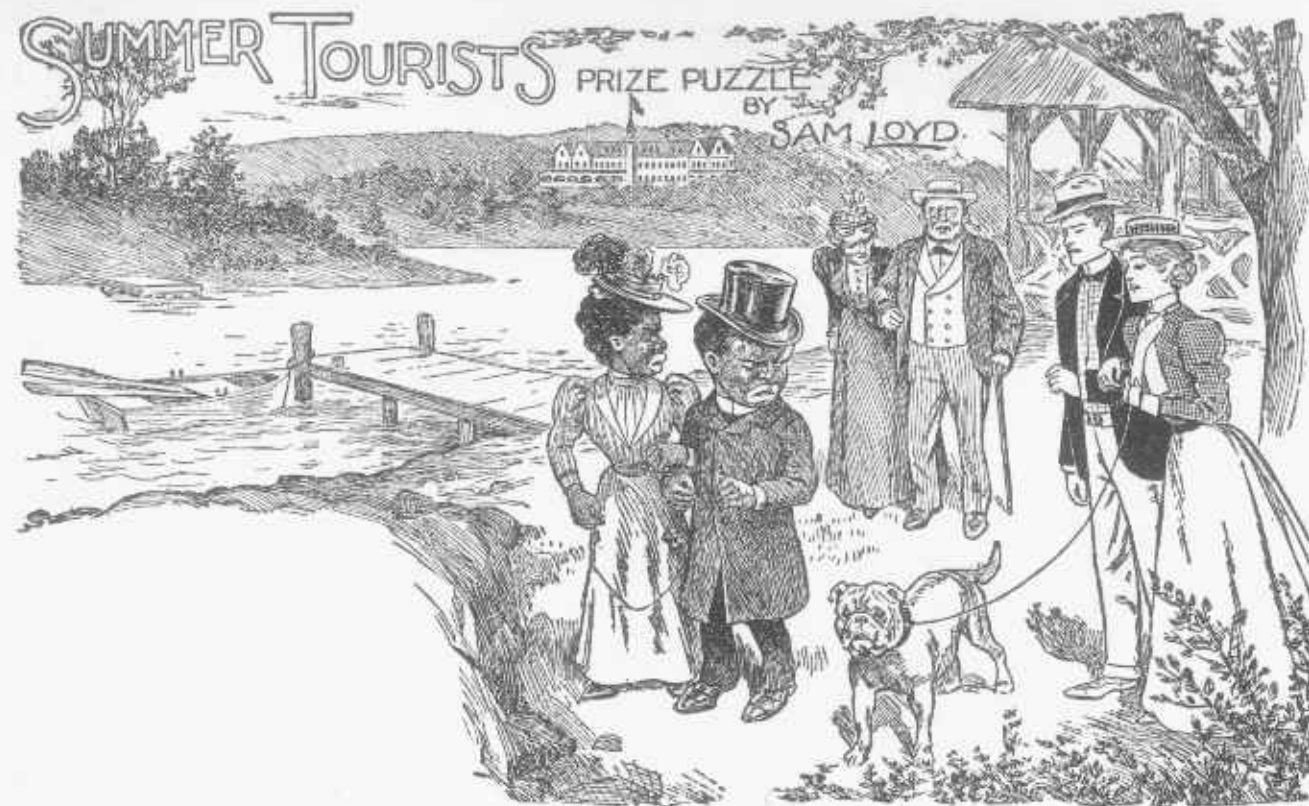

PROPOSITION Show how to ferry a quarrelsome party across the river in a boat that will carry but two



AS A PREFACE TO A very interesting problem which shows how a party of quarrelsome picnickers might cross a stream in the same boat without upsetting it, I shall take for granted that all puzzlists, young and old, are familiar with the ingenious tactics of the boatman who had to ferry a fox, a goose and some corn across a river in a small boat just "built for two." There is a German version of the story which tells of a peasant with a wolf, a goat and, I think a tomato can, which he was to get across the river in a way to circumvent the wolf's love for goat meat, as well as the natural tendency of the tomato can to telescope into the goat. Either of the stories, as familiarly told, possesses interest for the juveniles, and when solved would strengthen a branch of the memory and reasoning powers not generally called into exercise. To a trained puzzlist the problem possesses no difficulty what ever, but to one who is not versed in such matters, if he will just try to run the solution through his mind so test mentally just how many times the boat must cross the river, he will speedily realize what a valuable school it is for learning to concentrate the thoughts.

I wonder, however, if any of our readers who are familiar with both stories have chanced to realize what a funny state of affairs might arise if the two incidents were combined in one? That is a trick I often resort to when I have a couple of easy puzzles which are susceptible of being twisted together into one genuine poser.

Aided by the accompanying picture, which explains the situation in a way which words would fail to do, we will tell the story of a party of tourists, who, returning from a picnic were compelled to cross a stream in a small boat, which would hold but two at a time, and none of the ladies could row.

It so happened that Parson Cinch the popular colored preacher, had quarreled with the other two gentlemen of the party, and as a result Mrs. Cinch had a falling out with the other ladies.

How is it possible for the gentlemen to conduct them all across the stream in such a way that no two disagreeing parties shall ever cross over together or even remain on either side of the stream at the same time. Another curious feature of the strained relations being that no one gentleman should remain on either side with two ladies.

The puzzle is merely to show how many times the little two-seated boat must cross the stream, to ferry the entire party over; but I take occasion to say that not one person out of a thousand is endowed with a headpiece which would figure it out mentally, without recourse to pencil and paper, although the power or faculty of doing so may readily be acquired.

Used to Kissing.

They were in a magnificently decorated room in the West End of London. They approached each other from opposite directions.

Presently they met, and careless of the fact that dozens of eyes were watching them, they kissed each other with a resounding smack!

The meeting seemed to bring them perfect peace; but alas, alack! they had scarcely been side by side above twenty seconds when a man approached with the fire of battle in his eye. With cool insolence he raised the stick he carried, and then—oh, horror!—he struck a sharp, quick blow, and the pale one was sent spinning several feet away.

The other neither screamed nor fainted. There was no heart-breaking, no resentment; not even a murmur was heard, because —?

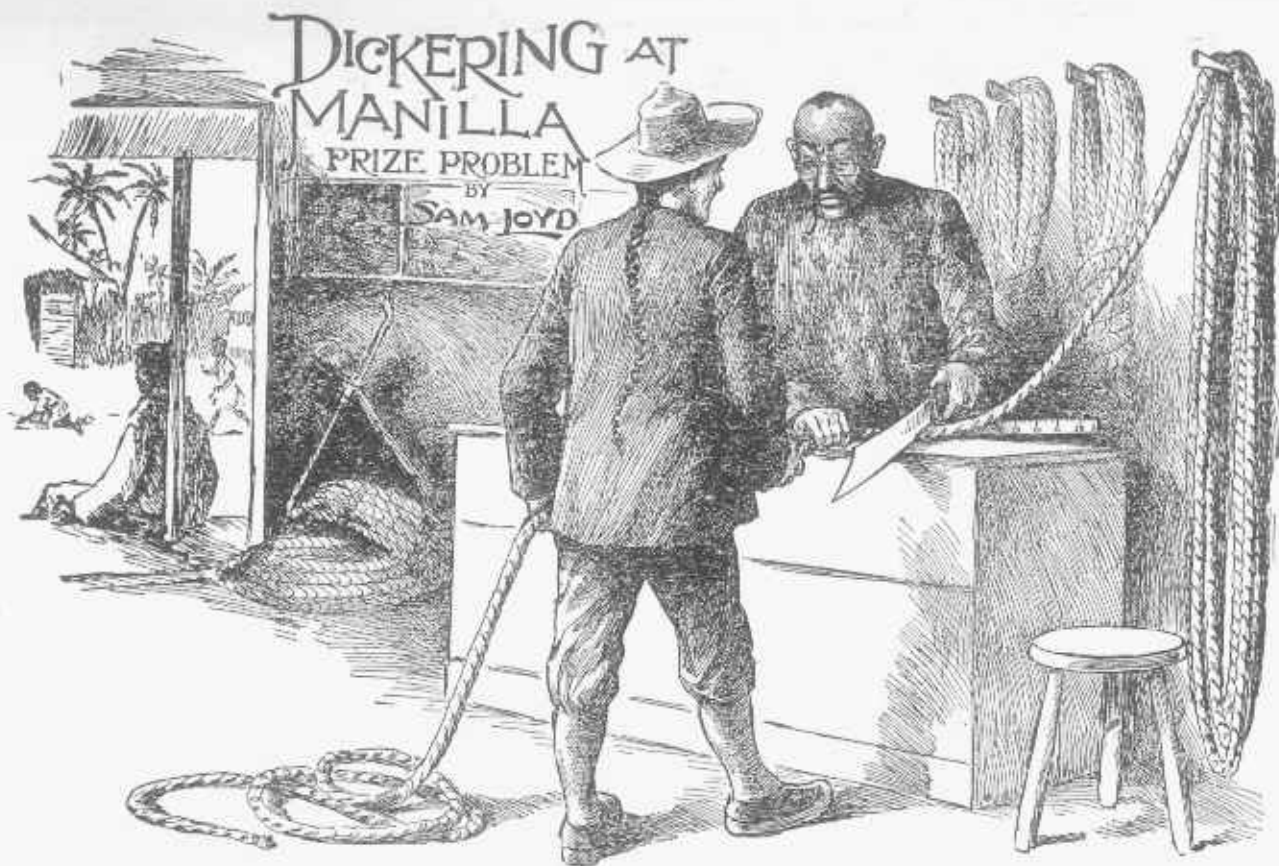

PROPOSITION—Tell how much is lost by measuring off 20 feet with a yard measure 3 inches too short

IS ANYTHING AND everything pertaining to the manners and customs of the people of our recently acquired possessions in the Far East will be of interest at the present time, let us look at the following account of the ways of doing business in the Philippines.

The hemp or manila rope trade, which is the most important industry of the islands, is controlled to a great extent by Chinese exporters, who ship these products to all parts of the world. The traders and small dealers are Japs, who have an original way of doing business, peculiarly their own. The lack of an established currency or fixed prices necessitates a dicker and wrangle over every transaction, with no redress from the lax laws if one is "skinned" out of his eyes.

The accompanying puzzle sketch shows the ordinary way of doing business. Omitting the vernacular as well as currency features, we will say a Chinese sailor man saunters into a rope store and asks, in a peculiarly aggravating way: "Can you direct me to a respectable shop

where they sell good rope?" The shopkeeper, swallowing the implied insult, says: "I keep only the best, but my poorest is probably better than what you want." "Show me the best you have; it may serve until I find better. How much you ask for the cable rope?" "Seven dollars the hank, 100 feet long." "Too long rope and too much money. I never pay more than \$1 for good, and this is rotten." "Standard rope", says the Jap, showing the unbroken seal, which guarantees the length and quality. "If you have but little money, take what you want for 2 cents a foot." "Cut off 20 feet," says the Chinaman, as he ostentatiously displays a five-dollar gold piece, to show that he can pay.

The Jap measures off 20 feet with an exaggerated display of anxiety to give full measure. The Chinaman notices, however, that the yardstick is just 3 inches shy, having been cut off at the 33-inch mark, so when the rope was cut he coolly points to the long end and says: "I take the eighty-foot piece. No, you need not send it. I carry it myself." Then he throws down the

counterfeit five-dollar piece, which the storekeeper gets changed next door. As soon as he gets his change he walks off with the rope, and in half a minute could not be tracked by the shrewdest detective in the world.

The puzzle is to tell how much the Jap has lost, assuming that he is called upon to make good the counterfeit five-dollar gold piece and that the rope was really worth 2 cents a foot.

A "Reel" Good Catch.

The next time you go to a party take with you a reel of white cotton and a needle. At the first opportunity thread the needle and drop the reel inside your breast pocket; pass the needle through your coat from the inside, and detach it from the cotton, leaving about two inches hanging upon the outside of your black coat. You will be interested to see how your friends will try to do you the kindness of removing the cotton, and the effect will be startling when they pull out an apparently endless length of thread.

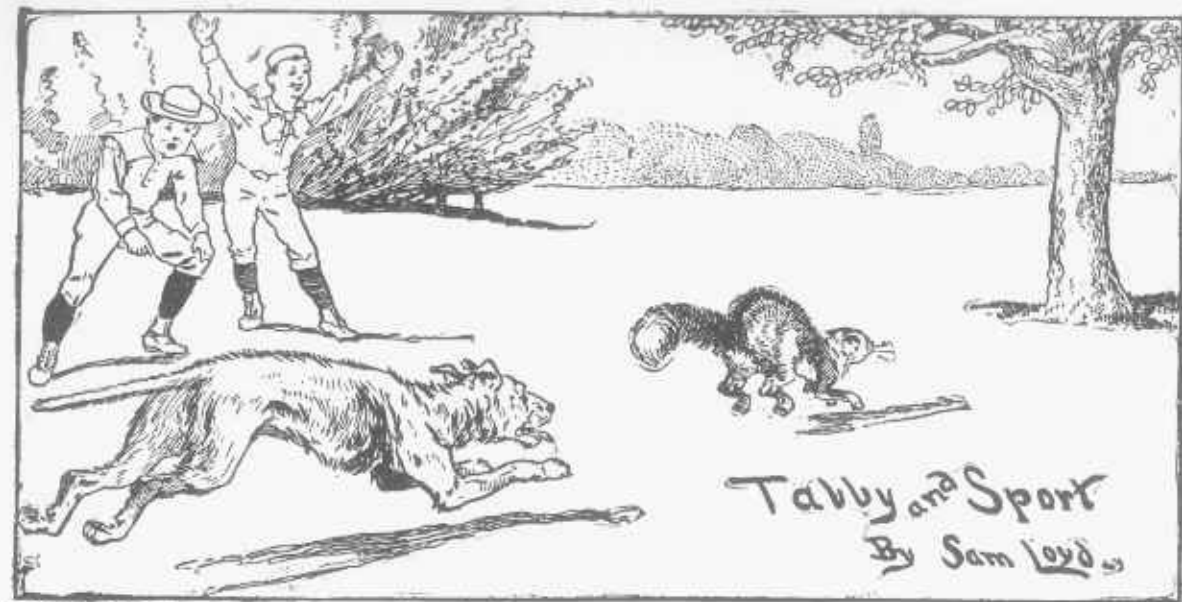

PROPOSITION—Tell the result of this race.



HERE IS A PROBLEM from one of our standard arithmetic books. Don't look in the book for the answer, nor ask your teacher, for he or she, as the case may be, accepts the recognized answer in good faith, so you would lose your chance of solving it correctly.

Tabby and Sport raced from a tree to a stake and back to the tree, distance in all, seventy-five yards. Sport sprang five feet at each bound and the cat only three, but then Tabby made five springs to Sport's three, so what should be the result of the race?

Caught by a Puzzle.

I remember, some forty odd years ago, that two Cincinnati editors became involved in a newspaper controversy, which for some time was conducted with all candor and courtesy. At length, however, one of them who was really getting the worst of the argument so far forgot himself as to become, first personal, then scurrilous, and then virulent, which induced the other to quietly withdraw from the contest. Editor No. 1 thereupon indulged in loud paens of victory, in which he boasted of "having spiked his adversary's guns," "put him to rout," "utterly demolished him," etc. While he was in this complacent frame of mind he received from an anonymous contributor a seasonable poem on "Spring," which he published, accompanied by a eulogium on its originality and beauty, with a warm-

ly expressed wish that the gifted author might often be heard from. The poem ran as follows:

SPRING.

The genial spring once more with chaplets crowned
Has showered her choicest blessings all around.
Each silent valley and each verdant lawn,
Enriched with flowers, looks smiling as the dawn.
Demure and modest hued the violet grows;
In yonder garden blooms the blushing rose;
To these the lilac adds her fragrant dower
Of perfume cherished by the sun and shower.
Reviving Flora walks the world a queen
Of kingdoms peerless as a fairy scene.
Far o'er the hills, in many a graceful line,
The rainbow blossoms of the orchard shine.
How softly mingled all their tints unite,
Embalm the air and bless the grateful sight!
Sweet voices now are heard on every tree,
The breeze, the bird, the murmur of the bee.
And down the cliff, where rocks oppose in vain,
Runs the clear stream in music of the plain.
In noisy groups, far from their southern home,
Now round the lofty spire the swallows roam;

The fearless robin builds with glossy leaves
Her fragile nest beneath the farmer's eaves;

Embowered in woods the partridge makes her bed
With silken moss o'er tender osiers spread;

Each happy bird expands his dappled wings,
Soars with his gentle mate and sweetly sings.

The sounds of early husbandry arise
In pleasing murmurs to the pale blue skies;

Shrill floats the ploughman's whistle while he speeds
Along the yielding earth his patient steeds.

Joyous the life which tills the pregnant soil,
And sweet the profits of the farmer's toil.

Content, as smiling as an angel face
Keeps peaceful vigil round his dwelling place.

And gentle Hope and Love, forever bright,
Smiling like seraphs in their bowers of light,

Salute his mornings and embalm each night.

A few days passed before the complacent editor had the mortification of reading in the other paper that "the editor of the 'Star of the West' has fully justified the acrostic contained in a beautiful poem on 'Spring' by publishing and indorsing it in his paper."

What is the worst kind of a seat a man can sit on? Self-conceit.



PROPOSITION—Tell what the men are laughing at.

WE CALL THE ATTENTION of our puzzlists to an interesting style of palindromic writing which affords scope for cleverness and ingenuity. The term palindromic, which means running backwards, is applied to words or sentences like *Eve, Hannah, and Noon*, or the famous introduction of Adam to Eve, when he remarked: "Madam I'm Adam." It applies as well to words or sentences which when read backwards will present an entirely different meaning, like *murder, Moor, dray, etc., etc.*, many of which will appear in other puzzles. The children's parade is given to illustrate a little political puzzle which was picked up on the street in the neighborhood of the Star Theatre. Irrespective of party proclivities the young kids are having a grand parade with a fusion of interests concentrated upon the gathering of ash barrels for a great bonfire. The puzzle is to guess why that cop concludes that the procession does not conflict with the ordinance as posted on the wall.

What is the oldest tree in America? The elder tree.

CHARADE.

Behold my first, with cautious air,
Placing my second as a snare;
But when by years maturer grown,
His thoughts assume a different tone
Oh! then with what assiduous care
He found my whole to please the air
Cypher Ans. 19, 15, 14, 14, 5, 20.

A REBUS.

My whole's a sad catastrophe
When none to help are nigh it;
Curtail, transpose, and you disclose
Who mostly suffer by it.
Cypher Ans. 23, 18, 5, 3, 11.

A REBUS.

See how majestic I am borne
Behead, some treat me then with scorn;
Yet knaves with all their art and guise,
Deem me to often as a prize.
Restore my head, transpose, what more?
I'm higher than I was before!
Ans. 13, 1, 3, 5.

CHARADE.

I lie and mislead
So I pray you take heed,
My wit's like the point of a thistle;
Be nice in your choice,

Take Franklin's advice,
And don't pay too much for your whistle.
Ans. 1, 21, 3, 20, 9, 15, 14, 5, 5, 18.

A REBUS.

I'm but a little letter, still
Have sacred duties to fulfill;
But if you take
My tail, you make
An alteration in my lot;
You'll say I'm shorter—but I'm not.
Cypher Ans. 14, 15, 20, 5.

When is a baby like a breakfast cup? When it's a tea thing (teething).

A REBUS.

Two personal pronouns if you take
And join them in due order,
An herb will name without mistake,
That scents the garden border.
Ans. 21, 8, 25, 13, 5.

Why cannot a deaf man be legally convicted? Because it is not lawful to condemn a man without a hearing.

How would you speak of a tailor when you did not remember his name? As Mr. So-and-So (sew and sew).

A problem in chances



AS SHOWING HOW puzzles of a very interesting nature may arise at any moment amid the various changes and chances of this mortal life, it may be said that George Washington Johnson, the very truthful guardian of the cloak room at a recent fashionable function, vouches for the correctness of the following problem. He says that at the close of the festivities there were just six hats left, but the applicants for the same were in such a helpless state of befuddlement that not one of them could produce his hat check, much less recognize his hat when he saw it, so in utter despair he was compelled to let each one make his own selection, and as it afterwards transpired, every one of the six persons took a hat which did not belong to him.

Now, George Washington J., like his great namesake, was one who could not fabricate, even if he desired to do so, nevertheless from a puzzler's standpoint it is interesting to determine the chances for and against such an event occurring as that six men each taking a hat at random should so happen that no man got the hat which belonged to him.

AN ENIGMA

I am a word of five letters, and dear to the ladies, and yet I have caused great calamities. Take away my head and I adorn an estate. Behead me once more and I am a place where all the world once congregated. If at first you curtail me I am a beautiful mineral. Curtail once more and I am a fashionable resort. To cut both my head and tail does not deteriorate my value.

Cypher Ans. 19, 16, 1, 18, 11.

The Comical Dog

We will ask you to discover the locality of the following hunting scene. With some brother journalists I participated in a gunning expedition in the wilds of New Jersey, and although it was a failure so far as game was concerned, we had a most amusing time at the expense of our crazy dog. He was emphatically a canine lunatic, given to posing in a sort of statuesque act which was exceedingly comical, but not conducive to filling our game bags. I snapped the kodak on him during one of his trances, thinking it would furnish a good subject for our juvenile puzzlists to laugh at.

When is an army totally destroyed? When the soldiers are all in quarters.

Why is too much whisky and champagne like the flowers that bloom in the spring? Because they make the nose gay (nosegay).



ADINCO PUZZLE

"AD" was the word the master gave to Dick,
Who scratched his head, and looking rather thick,
Replied, "Hereafter it would make it stick!"
"You may stay 'IN' an hour, you stupid dunce,"
The teacher said, "define an IN at once."
"I think," said Dick, with eyes upon the floor,
"Hereafter it would make it stick some more."
"Your back with that same stick, I'll put in CO,"
The teacher said, "unless this word you know!"
"Co," said Dick, "to me it seems, kind Master,
Hereafter it will stick the faster!"

What trade should one follow in order to cut a figure in the world? A sculptor.

When do cards most resemble wolves? When they belong to a pack.

What vine does beef grow on? The bo-vine.

What is the difference between the Mormons' religion and their wives? Their religion is singular, but their wives are plural.

When is a man duplicated? When he's beside himself.

What makes everybody sick but those that swallow it? Flattery.

What is that which never flies except when its wings are broken? An army.

Why is a drunken Irishman like a sentinel going his rounds? He is pat-rolling.



"Did the ancients live in the attic or in the cellar?"

I AM REMINDED OF some of the peculiar things I saw during an extended tour of the old world, especially connected with architecture, which seems to have escaped the notice of writers. In a certain locality, for instance, the name of which I have forgotten, it looked as if the dwellers had occupied the basements or attics of their houses, or had commenced the wrong way about, as we might term it, by constructing the roof first and then build down to the cellar.

I questioned the intelligent guide regarding the matter, and from my note book I find that he replied that "such was the case." The puzzle is to discover the locality concealed in the description of the ruins so as to locate these interesting ruins.

Lord Macaulay's Last Riddle.

Lord Macaulay, like Byron and Bacon, perpetrated quite a number of poetical riddles, which may be said to reflect the popular form of puzzles of those classical days. Here is the last effort in that line of the great poet and historian:

"Let us look at it quite closely,
'Tis a very ugly word,
And one that makes us shudder
Whenever it is heard.
It mayn't be very wicked;
It must be always bad,
And speaks of sin and suffering
Enough to make one mad.
They say it is a compound word,
And that is very true;
And when they decompose it,
(Which, of course, they're free to
do)—
If, of the letters they take off
And sever the first three,

They have the nine remaining
As sad as they can be;
For, though it seems to make it less,
In fact it makes it more,
For it takes the brute creation in,
Which it left out before.
Let's try if we can mend it—
It's possible we may,
If only we divide it
In some new-fashioned way,
Instead of three and nine, then,
Let's make it four and eight;
You'll say it makes no difference,
At least not very great:
But only see the consequence!
That's all that needs be done
To change this mass of sadness
To unmitigated fun.
It clears off swords and pistols,
Revolvers, bowie-knives,
And all the horrid weapons

By which men lose their lives;
It wakens holier feelings—
And low joyfully is heard
The native sound of gladness
Compressed into one word!
Yes! four and eight, my friends!
Let that be yours and mine,
Though all the hosts of demons
Rejoice in three and nine.

Becalmed.

To give our young yachtsmen a timely subject to puzzle over, I will mention that I was once an invited guest upon one of the yachts during a series of trial races for the selection of a defender for the cup in the international yacht races. I never posed as a yachtsman, and will not attempt to tell how they figure out that the losing boat sometimes wins. It may have been on points, or broken masts and spars, for I thought that our boat outrifted the other one; however, they said we were beaten on time allowance. Captain Shanks said the little puffs of air haven't much to do with the results, and I made a note of his remarks to accompany my sketch, as our young puzzlists will find the locality skillfully concealed in the words.

My first is a circle, my second a cross,
If you meet with my whole look out
for a toss.
Ox.

Why are deaf people like India shawls? Because you can't make them here (hear)!

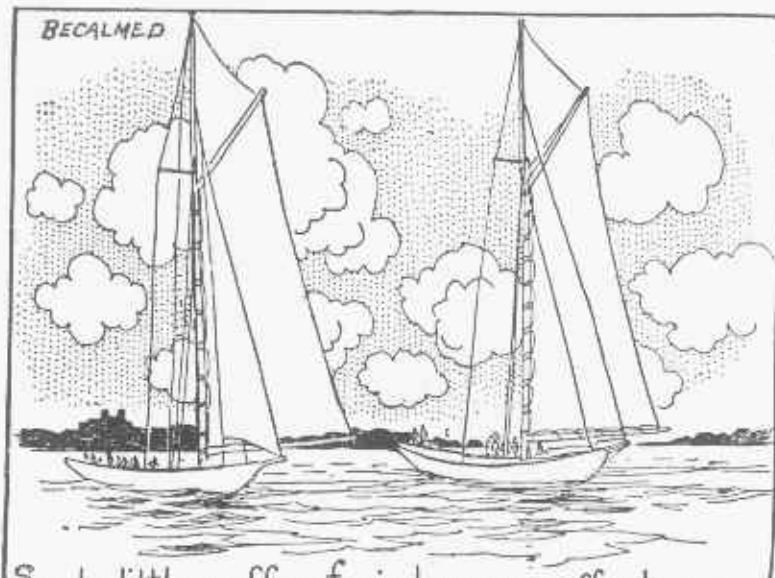

Such little puffs of air have no effect on the yachts.



PROPOSITION—Guess the weights of the different girls.

OF COURSE WE were all young once, so the following little problem from true life will interest some of the children of a larger growth.

Some school children who had discovered that by getting on a weighing machine in couples, and then exchanging places, one at a time, they could get the correct weight of a whole party on the payment of but one cent, found that in couples they weighed 129 pounds, 125 pounds, 124 pounds, 123 pounds, 122 pounds, 121 pounds, 120 pounds, 118 pounds, 116 pounds and 114 pounds. What was the weight of each one of the five little girls if taken separately.

It proves that they must have been clever scholars or they never would have been able to work out the correct answer to such an interesting puzzle question, which is liable to confuse older heads than theirs.

A REBUS.

My first in the garden luxuriant grows,
Delicious and sweet as everyone knows;
My second a noisy, vain, quarrelsome thing,
The lord of a harem, as proud as a king;
My whole is still prouder, and seems to rejoice
As much in his tail as he does in his voice.

Cypher Ans. 16, 5, 1, 3, 15, 3, 11.

When is wine like a pig's tooth?
When it is in a hog's head.
Why is a waiter like a racehorse?
Because he runs for cups, plates, and steaks (stakes).

The Price of Eggs.

This odd little problem in domestic arithmetic was sprung by the cook upon Mrs. Smith when she wanted to know what the grocer charged for such small eggs. "I paid twelve cents for the lot," replied Bridget, "but I made him throw in two extra ones, because they were so little, and you see that made them cost just one cent a dozen less than his first asking price!"

How simple and natural the whole transaction sounds, just as it might occur at home, and yet how many of our clever young puzzlists can solve Bridget's problem by telling just how many eggs she received for her twelve cents? It is a pretty

problem, which would only be spoiled spoiled if the terms were changed or made more complicated.

CHARADE.

My first presents an honored female name,
But lovingly abbreviated:
My next a man's, and treated just the same.
Now if this couple were but mated
And to the altar duly led,
To be my whole which might be said.

What is the difference between a cloud and a whipped child? One pours with rain, the other roars with pain.



PROPOSITION—What was the price of eggs?

The Young Carpenter's Puzzle



PROPOSITION—Into how few pieces need the table top be cut to complete the dog house?

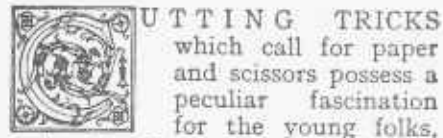

CUTTING TRICKS which call for paper and scissors possess a peculiar fascination for the young folks, and aside from the mere feature of affording pleasure in solving them should be recognized as an invaluable kindergarten school of mechanics and geometry. The picture tells its own story and does not require a Sherlock Holmes to see that the lads have found an old tool chest in the garret; that their mother is attending an afternoon meeting, and that it must be Thursday, when Bridget has her day out. There are other interesting features which suggest themselves, such as how Towser is to get out of the little door when the kids have nailed up the side of the dog-house. That, however, is a problem for Towser to settle in his own way, so we will waste no time in getting at the real point of the puzzle, which turns upon the best way of cutting the square top of the kitchen table into the fewest number of pieces which will fit together so as to close up the open end of the dog-house.

The feat can readily be guessed by puzzle methods, pure and simple; nevertheless, it will be found to be based upon scientific principles, which will interest those who love to acquire mathematical knowledge.

Why does the butcher's wife

always keep the books? Because the business is a joint affair.

What key is the hardest to turn? A donkey.

Bookworms.

The juveniles are given another lesson in concealed geography this week, to discover the locality of the place being discussed by these learned professors, as hidden in the description of the picture.

What is that which flies high, flies low, has no feet, and yet wears shoes? Dust.

Why is a ladder like a prize fight? Because it is made up of rounds.

Why had Eve no fear of the measles? Because she'd Adam (had 'em).

Why would you be justified in picking the pockets of a vender of engravings? Because he has pictures (picked yours).



"Do you find fiction as improving, in general, as Kane's Arctic Explorations?"

FRESHMAN & IMPERTINENCE



R T H D X X F R D
D N S D N T K N W
L D P R T F R M
L G W D

HERE IS A SOUVENIR from our college days which will interest the juvenile spelling class. It is built upon similar lines to the story of the epitaph upon the walls of the old abbey, which read:

P . R . S . V . R . Y . P . R . F . C T M . N
V . R . K . P T H . S . P R . C . P T S T . N

The dots represent a certain vowel which had faded from the inscription. In the present illustration the college professor of etymology was asked to construct the sentence properly by the introduction of the one vowel.

A REBUS.

My first you hear its sullen roar
When wandering by the ocean's shore;

My second in the gambler's art
Hath played no mean or paltry part,
But, fired with sordid thirst to win,
It often aids him in his sin.

My whole is something that is found
Upon the face of all around,
Yet if you take from me my face,
I am a title commonplace.

Cypher Ans. 19, 21, 18, 6, 1, 3, 5.

Why is an acquitted prisoner like a gun? Because he is charged, taken up, and then let off.

Why are horses little needed in the Isle of Wight? Because visitors prefer Cowe to Ryde (cows to ride).

Why are bad riddles like a deserted inn keeper? Because there is a host put out and not one guest (guessed).

A Puzzling Verdict.

Here is what we will term a necktie puzzle, wherein the object is to discover a missing word to be placed in the bow, so that by reading it twice as you go around the loop the sentence will be complete. I think the sentence in this case should have been a hempen necktie around the culprit's neck on account of a missing watch which was found in his possession, but by some twist of the law the sentence was defective, so I will ask our young puzzlists to supply the missing word! so as to make the sentence correct.

Why does a donkey eat thistles? Because he's an ass.

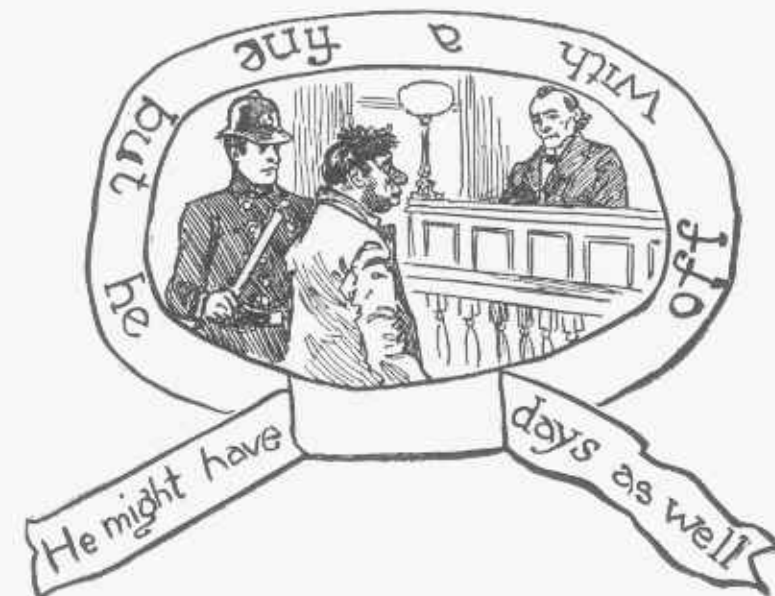

A REBUS.

My first is a color; my second an agreeable exercise; my third an article of clothing; and my whole a celebrated character, dear to the young folks.

Cypher Ans. 18, 5, 4, 18, 9, 4, 9, 14, 7, 8, 15, 15, 4.

A PUZZLE.

Place the same word in the blanks so as to make each line read properly.

1. The _____ to Fingal's cave would _____ the visitor.
2. The Arabs sometimes _____ travelers in the _____.
3. To select _____ sometimes _____ a writer to annoyance.
4. To excuse donating they _____ to the _____.

A CRYPTOGRAM.

E10100010001000 U N 1100 A T X N. Answer: Excommunication.

Take the bees away from something we eat and make it read out loud! Ans. Bread and butter becomes read and utter.

What is the difference between a bottle of medicine and a troublesome boy? One is to be well shaken before taken, the other to be taken and then shaken.

Why is a loaf of bread on the top of the Eiffel Tower like a racehorse? Because it is high bread.

At what time was Adam married? Upon his wedding Eve.

What part of a fish is like the end of a book? Don't you know? Why, the

FIN-IS.

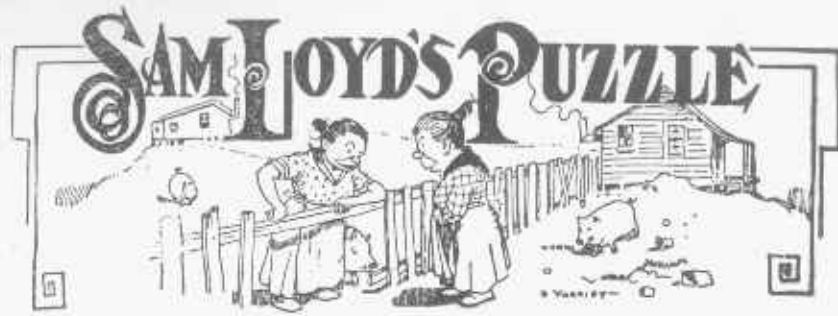

SAM LOYD'S PUZZLE

As showing how the keener sensibilities, when confined within the limitations of the domestic sphere, are prone to establish a new era, dating from some all-important episode, we quote a morceau of Cherry Hill gossip, incidentally allied to a pretty mathematical thought:

"You see," said Mrs. Murphy, "Paddy is now one and one-third times as old as he was when he took to drink, and little Jimmy, who was forty months old when Paddy took to drink, is now two years more than half as old as I was when Paddy took to drink, so when little Jimmy is as old as Paddy was when he took to drink, our three ages combined will amount to just one hundred years."

How old is little Jimmy?

At what age should a man marry? At the parsonage.

Why is an egg underdone like an egg overdone? They are both hardly done.

Why is a very old umbrella, that has been lost, as good as new when found? Because it's re-covered.

Why do the Salvation Army lassies walk on their heels? To save their soles (souls).

Why is the letter W like gossip? Because it makes ill will.

Which is the oddest fellow, the one who asks a question or the one who answers? The one who asks because he is the querist.

When does the wind most resemble a book-seller? When it keeps stationary (stationery).

What benefit can be derived from a paper of pins? It will give you many good points.

Why are authors who treat of physiognomy like soldiers? Because they write about face.

I went into the woods and caught it, I sat down to look for it, and then I went home with it because I could not find it. A splinter.

How did the whale that swallowed Jonah obey the divin law? Jonah was a stranger and he took him in.

A RIDDLE.

I captivate many when trained well by art,
To each lover of song an impulse impart;
Though to gay pleasure I'm closely allied
The grave son of care in me will confide;
The miser will smile when safe with his gold
My fairest of forms he has carefully roll'd;
I useful am found in commerce and trade,
To friendship and love I lend my kind aid,
Ladies then while you are aspiring to me
Let virtue and worth your motto still be;
Then grandeur may frown and envy may scorn,
But happy if merit your life shall adorn.
Ans. 14, 15, 20, 5.

A REBUS.

My first is found in many mints;
And there my costly second shines.
As for my whole—what shall I say?
It seems intended to betray.
Then, oh! beware unthinking youth,
Adhere to honesty and truth.
Cypher Ans. 19, 20, 18, 1, 20, 5, 7, 5, 13.

A RIDDLE.

Ladies a riddle I submit:—
To fifty now add one;
And, having thereby shown your wit,
You may my whole put on!
Cypher Ans. 12, 1, 3, 5.

A REBUS.

The things which daily fore me pass,
Cause me much deep reflection;
Behold me, 'twould be hard to make
A giddier selection.
Behold again sure stubbornness
Will scarce escape detection.
Cypher Ans. 7, 12, 1, 19, 19.

Why is the polka like bitter beer?
There are so many hops in it.

CONCEALED GEOGRAPHY.

133. I should be proud to entertain such a guest.
134. Shall we see the ghoul to-night?
135. Which do you prefer for lunch, clam, oyster, or turtle soup?
136. We eat the melon, but the rind gets thrown to the pigs. (Country.)
137. From wax tapers I anticipate a great deal of pleasure. (Country.)
138. My brother, I enter your house with pleasure.
139. My high-wrought exasperation filled the enemy with utter dismay. (State.)
140. They only light their astral Sunday nights.
141. He rode to Plymouth on a ticket for Quincy.
142. The siege of Sebastopol gave the French much trouble.
143. Madam Parepa lost her voice on that occasion.
144. The amphibious monster crossed the river on a raft.
145. Sarah ought on all accounts to be remembered.
146. Poor Sambo got a whipping for running away.
147. The Mustang I erroneously supposed peculiar to Mexico.
148. I must go somewhere for dinner.
149. Water I eat, bread I drink.
150. In trying to stop that animal I made a misstep and fell.
151. We must feed our cows with hay till next June. (Island.)
152. She wore a crepe ruche on her neck. (Country.)
153. The Queen of the Adriatic or King of Abyssinia must reign.
154. At the great Anawan I celebrated the Fourth of July.
155. I have a hundred and one; I dare say you have a hundred and two. (Lake.)
156. To a man under age, no agreement is binding.
157. The best cows are Alderney.
158. I met my great aunt on Washington street.
159. When the rain began to fall I made my friend put up her umbrella.
160. Our cook's name is Augusta.
161. Do you think books of travel are as interesting in general as Kane's Arctic Expedition? (Territory.)
162. Nine vehicles, in the open day, were stolen from the public way.

Why is a jailer like a musician?
Because he fingers the keys.

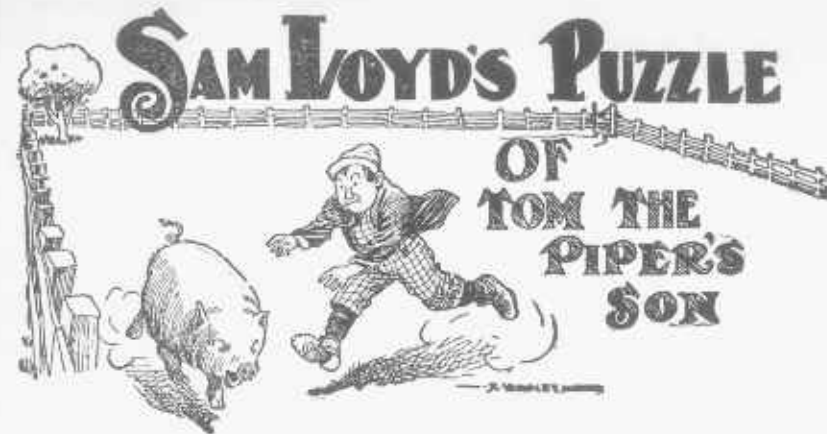

Here is the puzzle of Tom the Piper's Son, who, as told by "Mother Goose," stole the pig and away he run. It is known that Tom entered the far gate shown at the top on the right hand. The pig was rooting at the base of the tree 250 yards distant, and Tom captured it by always running directly towards it, while the pig made a bee-line towards the lower corner as shown. Now, assuming that Tom ran one-third faster than the pig, how far did the pig run before he was caught?

The puzzle is a remarkable one on account of its apparent simplicity and yet the ordinary manner of handling problems of this character is so complicated that solvers are asked merely to submit approximately correct answers, based upon judgment and common sense, just to see who can make the best guess. The simple rule for solving it, however, which will doubtless be quite new to our puzzlists is based upon elementary arithmetic.

A REBUS.

A pendent charm—bereft of tail and head,
A quadruped will give you in its stead.
Cypher Ans. 1, 13, 21, 12, 5, 20.

When is a lady's dress like an unfortunate bull-fighter? When it is gored.

Why is an old man's farm in Texas like the focus of a sun-glass? Because it's a place where the sons raise meat (sun's rays meet).

Add half a score to nothing, and what animal does it make? OX (ox).

What shape is a kiss? Elliptical (a lip tickle).

How is it that trees can put on new dresses without "opening their trunks?" Because they leave out their summer clothing!

A REBUS.

My first is found in every country of the globe; my second is what we all should be; my whole is the same as my first.
Cypher Ans. 13, 1, 14, 11, 9, 14, 4.

How many foreigners make a man uncivil? Forty Poles make one rude (rood).

How many weeks belong to the year? Forty-six; the other six are only lent (Lent).

Why is a watchdog bigger by night than by day? Because he is let out at night, and taken in in the morning.

What confection did they have in the Ark? Preserved pairs (pears).

Students of concealed geography are given an opportunity to exercise their ingenuity in discovering the locality where according to tradition the custom of ringing the merry wedding bells is said to have originated.

A REBUS.

I received the following communication the other day from a young puzzlist:

Missed her—trees being at the of king of terrors, 10 mills for his quakers, and who, which and what. They order for Dr. Juvenile Humanity (who)—2 Dr. Haypreservers, little devil behold gold band servants; Cigar stump B4 he arrived, the not legally good changed color.

Here is the intended translation: Mr. Dashwood, being at the point of death, sent for his friends and relatives. They sent for Dr. Childs, who inclosed a short line to Dr. Barnes imp-lo-ring help, but before he arrived the invalid died.

What is the difference between a beehive and a bad potato? None at all; as the one is a bee holder (beeholder) the other a speck'd tatur (spectator).

What's the difference between a piece of honeycomb and a black eye? One is produced by a laboring bee, and the other by a be-laboring!

Which of the four seasons is the most literary? Autumn, for when the leaves are turned, they are red (read).

When is a young lady not a young lady? When she's a sweet tart (sweetheart).

How does a pitcher of water differ from a man throwing his wife from a bridge? One is water in the pitcher, and the other is pitch her in the water.

What is the difference between an angler and a dunce? One baits his hook; the other hates his book.



In that county the brides wear white, the bridesmaids blue.

AESOP'S UP TO DATE FABLES BY SAM LOYD.



A Rebus.

To a word of denial add one to incite,
You'll see what there passes 'twixt
morning and night.
Cipher Answer.—14, 15, 15, 14.

A Rebus.

My second, who is a relative, took
my first, after using my whole at dinner.
Cipher Answer.—14, 1, 16, 11,
9, 14.

Aesop tells of a hungry wolf, who, seeing a fat little goat sleeping on a roof top, resolved to capture a meal by impersonating a policeman who would accuse the youngster of throwing snowballs at him, and of having butted him on a previous occasion.

"How could I throw snowballs at you in July, when there is no snow?" said the trembling kid, as he came down from the roof. "Moreover, I have been asleep for an hour and never dreamed of such a thing, and I am not the kind of a kid to toss coppers."

"You offer an ingenious equivocation in place of a straight denial, and I despise a person who puns," replied the cruel wolf as he seized his victim. "To pelt a cop with snowballs is only a misdemeanor, and would have only cost you your pelt in return, but out of your own mouth you are now convicted of a heinous crime, and I will have to take you in!" Which he proceeded to do. Of course, the moral of this true tale is that it is folly to come down to argue with a cop, but how many of our clever puzzlists can guess this conundrum by telling the nature of the charge against that poor little kid?

Why have miserly people never quarreled?
Because they have always a-greed.



When Smith bought a farm he engaged three foreigners to do the work, agreeing to pay the foreman \$1.10 per day, the handy man \$1, and his helper 90 cents, so as to average \$1 per day. They contracted to work 101 days for \$303, but on the second day two of them organized a planters' and diggers' association,

and asked for shorter hours with increased pay. Recognizing the justice of their demands, as explained by the entertainment committee, he increased the wages of two of the men so that every one was satisfied, and yet at the end of the season each man received \$101, and there had been just 303 days' work done.

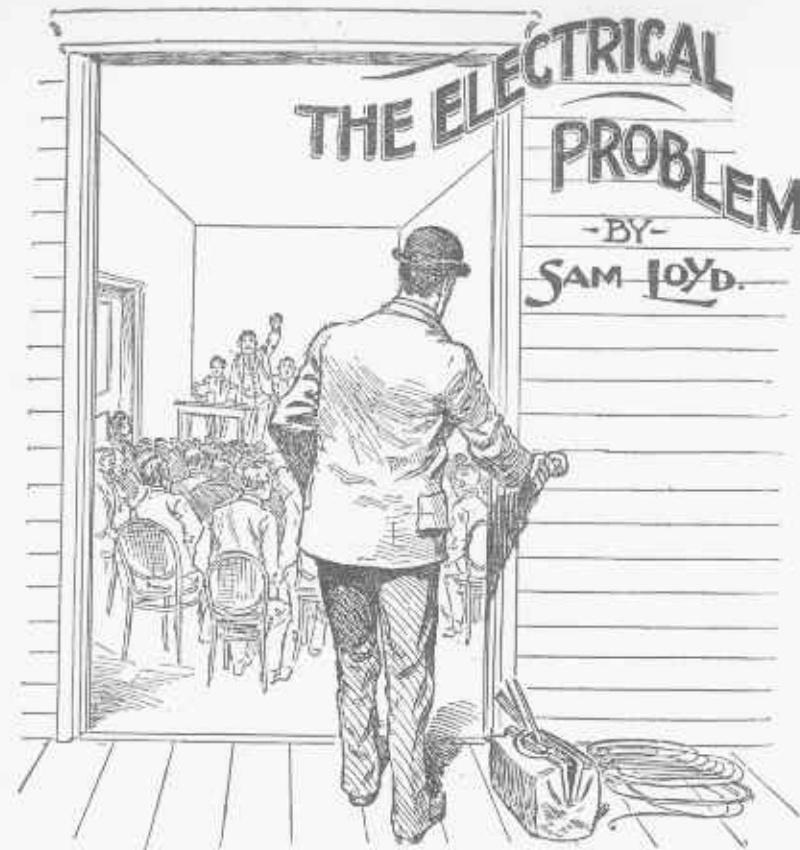

HERE is a practical problem in electrical wiring which developed recently at a county convention and which will amuse and instruct our puzzlists. It gives ample scope for one's genius for estimating and guessing, so it is safe to say that the clever wits will find no trouble in mastering such a practical problem.

It appears that at a recent primary meeting an electrician was given a contract to place an annunciator in the back of the hall, to be connected with a push-button at the front door, so that the managers could notify the long-winded orators when to ring off. The length of the wire required for the work gave rise to quite a discussion between the workmen, and the question was referred to me, and I find that it involves a problem which I am sure our puzzlists will be qualified to tackle.

The hall was just twelve feet wide by twelve feet high and thirty feet long, and, as shown in the picture, the wire must be strung along the wall, ceiling or floor from the annunciator, three feet from the ceiling in the center of the back wall, to a push button three feet from the floor, in the center of the front wall, near

door, as shown. The thickness of the wall, nor the question of single or double wire need not be considered; the problem is merely to give the length of the shortest route where the wire should be strung.

A Charade.

Complete I'm unpleasant to hear,
Behold, I'm not so to the taste;
Behold again, there's a great deal
Of what scribblers too often waste.
Cipher Answer.—19, 3, 18, 5, 1, 13.

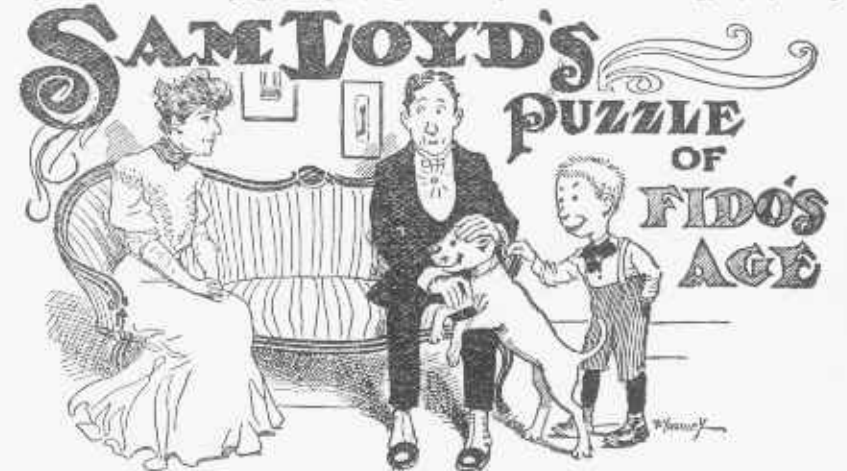

"You can't tell a dog's age by the number of rings in his bark," said l'enfant terrible, "but five years ago sister was four times older than

Fido, now she is only three times as old!" Charley Slowpop is very anxious to know Fido's age. Can you help him?

A Rebus

I cheer the pilgrim's lonely way,
As toils he on from day to day;
Curtail me, and I then am found
What students do on college ground;
Curtail once more, and by inspection
You'll find I am an interjection.

Cipher Answer.—8, 15, 16, 5.

Illustrated Charade



Can our young folks tell why
both of these illustrations are
just alike?

A Charade.

My first, kind reader, is thyself;
My next is in the sea,
My whole to many will apply,
But not to thee and me.

Cipher Answer.—20, 8, 15, 21, 19,
1, 14, 4.

A Charade.

Of a monster I've read, which de-
prived of its head,
Is strong, healthy, hearty and
clever!
And if you repeat, a brew you will
greet

That is hearty and healthy as ever.
Cipher Answer.—23, 8, 1, 12, 5.



The above picture of Master Sam Loyd was made in 1850, and shows the nine-year-old lad giving an exhibition of lightning calculating. As his mathematical and chess problems of that date are well known, we will give his earliest recollection of precocious figuring. His father bought two hammers from a pedlar, and said "The man offered me one for fifteen cents, or two for a quarter, and said he would make just as much profit whichever I took." "Then," said Sammy, who was but four years old, "the hammers cost him ten cents apiece, for if he made the same profit in either case, he must have sold the second one at cost." It is a simple problem devoid of all difficulty, but shows the correct manner of getting at the reason why.

Puzzling Synonyms.

1. Behead a musical instrument and leave a musical instrument.
2. Behead a margin and leave a margin.
3. Behead a class of animals and leave one of the same class.
4. Behead a vessel and leave a vessel.
5. Behead an animal and leave an animal.
6. Behead to liquefy and leave to liquefy.
7. Behead to ascend and leave to ascend.
8. Behead a woman's name and leave a woman's name.
9. Behead an animal and leave the class to which it belongs.
10. Behead to move slowly and leave to move slowly.
11. Behead a woman's name and leave a woman's name; again, and leave a man's name.
12. Behead and curtail a bird and leave a bird.
13. Curtail a lamentation and leave to lament.
14. Curtail a protection and leave a protection.
15. Curtail to blemish and leave to blemish.
16. Curtail to disclose and leave to disclose.

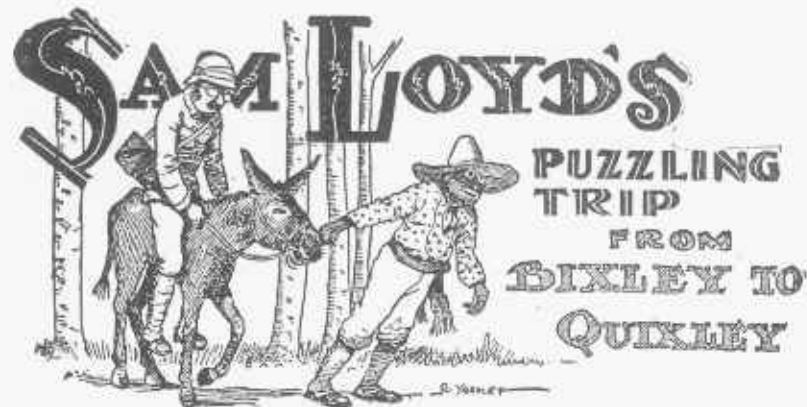

Here is a pretty problem which I figured out during a ride from Bixley to Quixley astride of a razor-back mule. I asked Don Pedro if my steed had another gait, and he said it had but that it was much slower, so I pursued my journey at the uniform speed as shown in the sketch. To encourage Don Pedro, who was my chief propelling power, I said we would pass through Pixley, so as to get some liquid refreshments; and

17. Curtail to conceal and leave concealed.

Answers to the above will be found among the following words:

Mar-k, P-love-r, M-avis, S-melt, L-lama, F-lute, Ope-n, Complain-t, F-lag, A-rise, C-raft or B-ark, B-rim, Hid-e, Cover-t, A-m-abel, M-adeline, F-ox.

A Baseball Problem.

The game was between the "Sockerers" and the "Sluggers." The Sockerers were first at the bat. At the end of the eighth inning neither team had scored. The final score at the end of the ninth was 5 to 2. Which won?

A Legal Problem.

A correspondent who wishes to lay a claim to an estate in chancery asks if there is a law in any of our states which would have prohibited his grandfather from marrying the sister of his widow. He says that the entire proof of his right of inheritance to an old farm now covered with sky-scrapers and palatial residences turns upon the solution of this question. What have our correspondents to say on the subject?

Can you tell of what nationality Napoleon was? Of course I can (Corsican).

Why is your mother like your grandmother? She is your aunt's sister (ancestor).

CRISS-CROSS PUZZLE

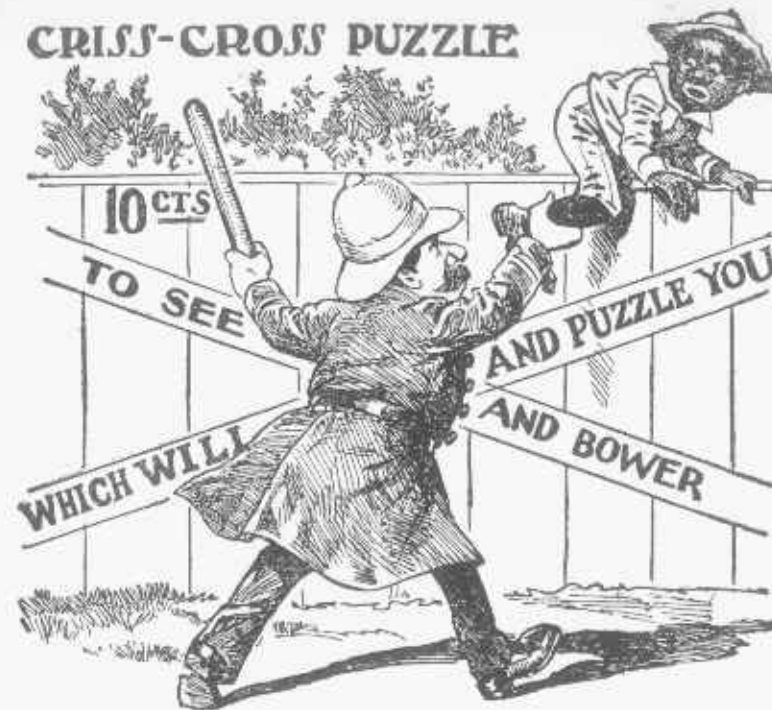

Here is a new style missing word puzzle for the young folks which will tell you just what that little coon expects to see without the formality of paying a dime. You see, there is some sort of a show going on, as described by the sign on the fence; I can't tell you exactly what it is, because one word is hidden by the cop, so you will have to guess it. Place a word at the intersection of the two sentences which will make them both read correctly, and you will know all about it.

Can These Things Be True?

A traveler in a little Canadian village had stoped to speak to an old man who was sawing wood in a back yard, and said to him, pityingly, that he must see very few things of any interest in so narrow and confined a life. The old man was sharper than he looked, and replied as follows:

"Though seldom from my yard I roam,
I saw some squeezer things here at home.
I saw wood floating in the air;
I saw a skylark, bigger than a bear;
I saw an elephant with arms and hands;
I saw a baby breaking iron bands;
I saw a blacksmith weighing half a ton;
I saw a statue sing and laugh and run;
I saw a schoolboy nearly ten feet tall;

I saw an oak tree span Niagara fall;
I saw a rainbow, black and white and brown;
I saw a parasol walk alone through town;
I saw a politician doing as he should;
I saw a good man—and I saw some wood."

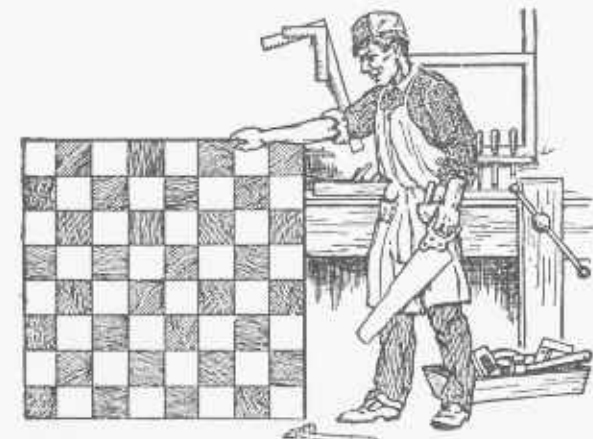

This clever young carpenter received a chest of tools for a Christmas present, and immediately set to work to make a fine chess-board to present to Dr. Lasker, the chess champion of the world, who is a great mathematician and puzzlist. Dr. Lasker is a marvelous chess-player, but Harry wonders whether he can beat our puzzlists in discovering into how many pieces this chess board can be divided (on the lines)

Now, how many of our clever puzzlists can decipher the old man's remarkable story so as to tell just what he meant, and to show that he was not such a lineal descendant of Baron Munchausen as his wonderful tale would seem to imply?

A Rebus

At the still hour of eve, when nature reposes,
And sweets are emitted from lilies and roses,
To insects and bees my first does belong,
Like the musical notes of a beautiful song.
To my second I like not to own recognition,
But in duty I'm bound to give some definition:
All are reluctant to make the confession
When in the head it has taken possession.
My whole is a term more of fashion than rule;
Expressing the has-been, the would-be, the fool:
'Tis what all honest men most justly despise,
And is easily discovered by such as are wise.
Cipher Answer.—8, 21, 13, 2, 21, 7.



AMONG the great men of our times, noted for overcoming early obstacles and battling their way to success, the late Henry George should be accorded a well deserved prominence. By the profound study of his one dominant subject, the author of "Progress and Poverty," had acquired a familiarity with every possible phase of argument that made him absolutely invulnerable in debate. We often discussed the problems pertaining to single taxation, and, although astonished at the readiness with which he demolished objections which others could not answer, I became firmly convinced that there would be no competent successor to take up his mantle.

Who but Henry George could give a sound and satisfactory reply to the proposition: "If buildings, as representing labor, are to be free from taxation, how about the poor man's house or store which occupies just as much land as the capitalist's adjoining five million dollar free-from-tax office building? And from whence should the city derive its necessary income?"

Half of the people of the United States would vouchsafe an off-hand answer to this problem, while, as a matter of fact, the best of them could ponder over it for a life time without

reaching a definite conclusion. At one time, when we used to meet almost daily at the Press Club, Mr. George had been tantalizing me with some of his mighty problems on political economy. I retaliated by offering a puzzle of my own, which offers a wide range of possibilities—from a simple trick which a child might guess in a minute—to an endless chase through Webster's Unabridged.

It is built on the principle of the old star puzzle which consists in filling up the points of a star with counters according to the following rule: Take a counter and place it on point No. 1, and then give it one jump—as in checkers—forward or backward to No. 3 or No. 12; then place another, say on No. 2, and jump along this line to No. 4 or No. 13, and so on until all of the points are covered but one.

The idea of the Henry George puzzle is to select a word of twelve letters, and write a different letter on each of the counters. Then take them up in regular order, beginning with the first letter of the word, and see in how few jumps you can make the word spell properly.

It is a puzzle pure and simple, yet puzzles of this kind develop a knowledge of the meaning and characteristics of words, for it will be found that different words produce differ-

ent answers and call for skill to play them.

Henry George was greatly pleased with the puzzle and paid me the equivocal compliment of saying it was "the brightest thing I had ever originated." See if you can find a good twelve-letter word which can be readily placed upon the points.

Concealed Geography

163. I am decided to go at last, or I am not in my right mind.

164. Neither men, butterflies, nor angels can sew on a button.

165. A man took his soft soap to Sebastopol, and thence to his castle in the air. (Country.)

166. Anna's sausages are the very best I ever ate.

167. A Jewess went to Cuba, that loved Henry the 8th.

168. If you carry into a room a half-dozen oysters, they will blush like a rainbow.

169. If any one stabs a rat, O, gather up the fragments.

170. My sister had a fall by which she was lamed for days.

171. The country everywhere about here is very green.

A Cryptogram

I Y Y I own concert.

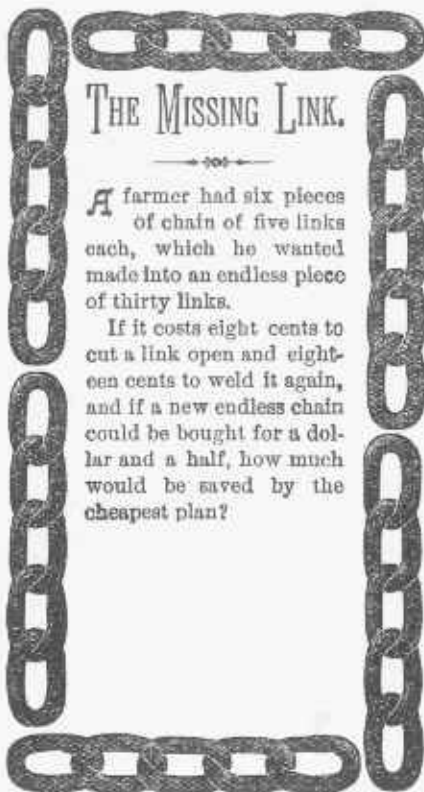

THE MISSING LINK.

A farmer had six pieces of chain of five links each, which he wanted made into an endless piece of thirty links.

If it costs eight cents to cut a link open and eighteen cents to weld it again, and if a new endless chain could be bought for a dollar and a half, how much would be saved by the cheapest plan?

The Tower of Hanoi

M. De Parville gives the following story of a remarkable puzzle. In the great temple at Benares, says he, beneath the dome which marks the center of the world, rests a plate of brass in which are fixed three diamond needles, each a cubit high and as thick as the body of a bee. On one of these needles at the creation was placed sixty-four discs of pure gold, the largest disc resting on the brass plate, and the others getting smaller and smaller up to the top one. This is the tower of Bramah. Day and night unceasingly the priests transfer the disc from one diamond needle to another according to the fixed and immutable laws of Bramah, which require that the priest must not move more than one disc at a time and that he must place this disc on a needle so that there is no smaller disc below it. When the sixty-four discs shall have been thus transferred from the needle on which they were placed at the creation to one of the other needles, tower, temple and Brahmins alike will crumble into dust, and with a thunder-clap the world will vanish!

The number of separate transfers of single discs which the Brahmins must make to effect the transfer of the tower is $2^{64} - 1$, that is 18,446,

744,073,709,551,615, a number which, even if the priest made no mistakes and could make one transfer per second, would require many thousands



of millions of years to carry out! As our puzzlist could not afford to spare the time to solve such a complicated puzzle, we give them just thirteen discs from the top of the tower and ask in how many transfers can the change now be made? The discs are in one pile, and you are allowed two other places to build on, but are never to place a larger disc above a smaller one.

A Rebus

An implement in daily use
In city, town and village;
The swain will not its aid refuse,
Employed in acts of tillage.
Beheaded, you'll a shelter ken,
When wintry storms are raging;
Once more behead, transpose; I'm there
A passion most engaging.
Cipher Answer.—19, 8, 15, 22, 5, 12.

A Rebus

Protect my first, wee, helpless elf,
It asks your tender care;
My second graced my grandma's head,
At market, church or fair;
My whole, a retrospective glance,
Appears a summer's morn;
A fading dream of fairy joys,
Gone, never to return.
Cipher Answer.—3, 8, 9, 12, 4, 8, 15, 15, 4.

A Rebus

In every hall my first is found,
Convenient to the hand;
No structure raised above the ground
Without my next could stand.
My whole, although a little toy
With simple science fraught,
It charms the heart of every boy,
And gives them food for thought.
Cipher Answer.—16, 5, 7, 20, 15, 16.

A Charade

My whole is both common and useful
I ween,
Or yet may be precious and rare;
It both in the cottage and palace is seen,
And often adorneth the fair;
Behead; 'tis either exquisitely sweet
Or harsh and ungrateful it sounds.
Curtailed; it is massive—to make it complete,
You must furnish a good many pounds.
Cipher Answer.—19, 20, 15, 14, 5.

A Charade

When your fine vessel on the ocean speeds,
Unto my first the watchful tar's attending;
And yet my second oft employs his thoughts,
When at my whole his powerful form is bending.
Cipher Answer.—23, 9, 14, 4, 12, 1, 19, 19.

A Rebus

My first encircles all the earth;
You date my second from your birth;
My whole is always backward traced,
Hoping it never was disgraced.
Cipher Answer.—12, 9, 14, 5, 1, 7, 5.

Take the bees away from something we eat and make it read out loud.

Answer.—Bread and butter becomes read and utter.

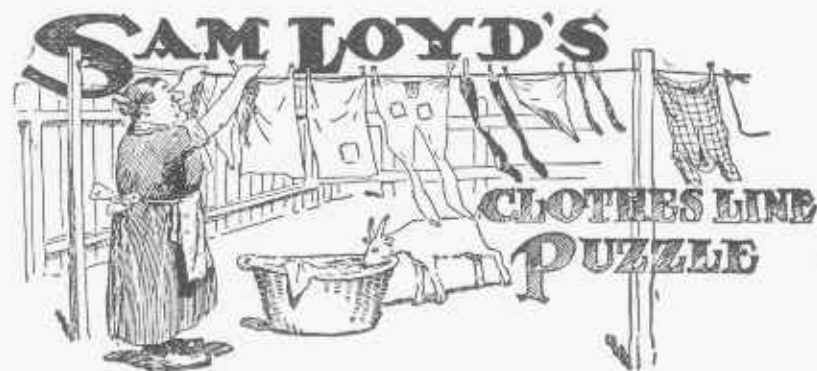

Mrs. Hogan bought a new 100-foot clothes line with her friend Mary O'Neill, but as she paid the larger

part of the bill, one piece was only five-sevenths of the length of the other. What were the lengths of the pieces?

PUZZLE OF AN ECCENTRIC WILL



When Capt. John Smith died at Gloucester in the year 1803, a respected and worthy citizen, he left the proceeds of his successful ventures in the slave and smuggling traffic to his nine heirs—consisting of a married son with a wife and child; a married daughter, her husband and child, and a stepson, who also had a wife and child—as pictured above. He stipulated in his will that each of the husbands should receive a specific sum of money more than his wife, but that she in return was to receive just so much more than their child. This arrangement pacified the good wives, who in their ignorance of figures supposed that they would lose nothing, as they would get just as much from the children as they had to give to the husbands! It was a cunningly devised will, executed in such a way that none knew how much was left to the others. The money consisted entirely of one-dollar bills, and each heir received a package of sealed envelopes, each envelope containing just as many dollar bills as there were sealed envelopes in his or her original package. Each package being marked with the name of the person for whom it was intended, it is evident that even the executors did not know how much each one received, although it was stated in the will that "Mary and Sarah together get just as much as Tom and Bill together, while Ned, Bill and Mary together get \$299 more than Hank. In consideration of the needy circumstances of the Jones family, they get over one-third more than the Browns."

and the amount of money each received, for the curious feature of the puzzle is that it shows which are the wives and children.

A Rebus.

I hope you have two of my first;
My next we will term an extreme;
My whole pertains to ancient tales,
Wild and romantic as a dream.
Cipher Answer.—12, 5, 7, 5, 14, 4

A Rebus.

My whole is acknowledged a place of repose,
And for me oft a wish is expressed,
My head now displace and you'll quickly disclose
A bright grace by the ladies possessed;
Again me decapitate, and then you decri,
Without which all Nature would speedily die.
Cipher Answer.—3, 8, 1, 9, 18.

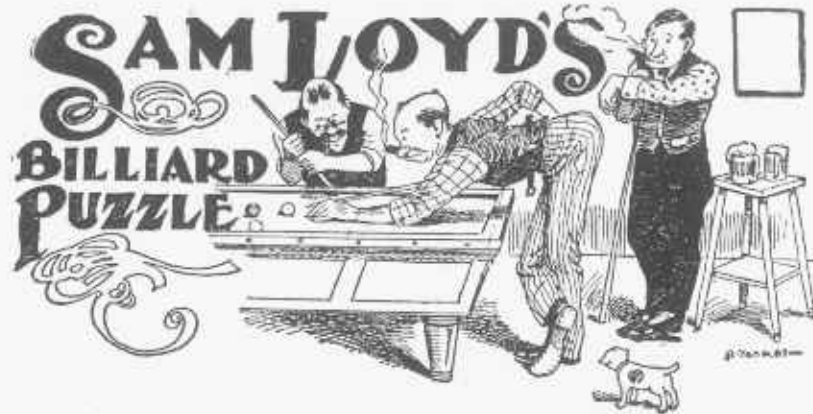

Prof. Apfelbaum was playing billiards the other day with his friend, Blumenstein, giving him the odds of 20 points in 100, when Gugelheim, to whom Blumenstein gives 25 points in 100, came in and proposed a three-handed game of 200 points. Of course the usual discussion ensued

A Charade.

My wife's last dress of *one* is made,
And shows, in hue, a lovely shade.
When she sits down to *two*, I think
She is perfection's very pink.
And when at fairs—now all the go—
Where apple-sauce the ladies show,
She on parade appears, she draws
The eyes of people all, who pause
To scan her outfit, fine and neat,
Made of rare *one* I here complete.

A Rebus.

View yonder smiling bonny lass;
My first sometimes she's reckon'd,
And you will notice as we pass,
Her cheeks outvie my second.
Around her cottage in the spring
My whole you may discover;
Like her a simple, modest thing,
With many an ardent lover.
Cipher Answer.—16, 18, 9, 13, 18, 15, 19, 5.

regarding the number of points that Prof. Apfelbaum should give Gugelheim, and it developed that no two players, puzzlists or mathematicians, could be found to agree upon the simple proposition: A can give B 20 points and B can give C 25 points in 100; then how many points can A give C in a game of 200?

PICTORIAL ARITHMETIC



To familiarize Harry with the arithmetical signs of multiplication \times , addition $+$, subtraction $-$, division \div , and equality $=$, teacher has placed a kindergarten sum in pictorial arithmetic upon the black board. It is a very elementary lesson which will pave the way to the use of the other signs employed in algebra which are not so generally known, as \therefore which stands for is to, \therefore so is. Thus we would write as $2:4::8:16$. This being interpreted reads, as 2 is to 4 so is 8 to 16. Then we have the signs \therefore hence or therefore, and \because which means since or because, all of which will be found useful in puzzeldom.

A Puzzling Query.



How do I know that this man is preparing a great feast?

Square Words

Of course all puzzlists know how to make square words. Take a word that means frozen water; what parents given to children; a sign, and a word that indicates gone. They will form a square word, the same from the top down or from left to right. The answer to this, of course, is:

S N O W
N A M E
O M E N
W E N T

A better way to form puzzles of

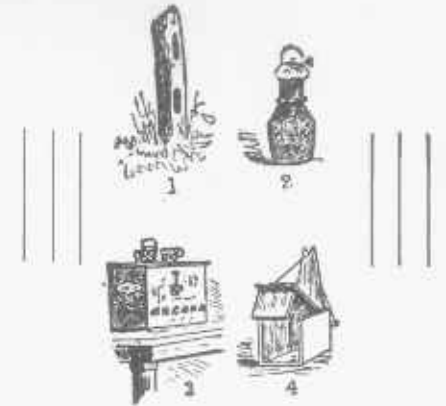

The most remarkable square word extant is the seal of the McCormack's, the inventor of the reaping machine.

S A T O R
A R E P O
T E R E T
O P E R A
R O T A S

This Latin inscription reads the same from four directions, up or down, right or left, and freely translated, says: The reaper shall cease from his toil as the mower works his wheels.

A Rebus.

A pleasant herb, or what relieves our pain,
Transposed will sport upon the verdant plain.
Cipher Answer.—2, 1, 12, 13.

this kind is by the aid of pictures, which leaves more to the imagination to tell what they represent. Here is a simple illustration of a square word:



The Family Puzzle.

Farmer Smith and wife say that the race suicide scare is of no account down their way, as they have fifteen children born at intervals of one year and a half. Miss Pocahontas, the eldest of the children, who is

reluctant about mentioning her age, admits she is seven times older than Captain John, jr., the youngest of the brood.

Can you assist the census man in figuring out the age of Miss Pocahontas,

THE POSTMASTER'S PUZZLE



"No one would believe the absurd experiences I go through nor the silly questions I am asked to answer during the course of the day," said the rural postmaster.

"A few days ago a smart Alec came with a letter appointing him to stand by the stamp window holding out his tongue for people to moisten stamps on. While I was trying to convince him that he was the victim of a practical joke one of those weak-minded correspondents who answer fraud personals came along and asked:

"Is there a letter here for me?"
 "What's the name?" says I.
 "He signs his name just 'Honorable,' says she, 'and it would come by the first New York mail.'
 "But what is your name?" says I.
 "Smith," says she.
 "Married or single?" says I.

"None of your business," says she. 'Just give me my letter, or I'll know the reason why,' and then she planks down a dollar bill and says, 'Give me some two-cent stamps, ten times as many ones, and the balance in fives.' There's a puzzle to give the Postmaster General a pain. Some two-cent stamps, ten times as many one-cent stamps as twos, and the balance in fives! Just figure it out and tell how many stamps she got for her dollar."

A Rebus

Take the head of a fish and the heart of an ace,
 With one-fourth of whatever is mean and base;
 To these add a title of highest degree,
 And the meanest and basest of mortals you'll see.

SAM LOYD'S MYSTERY PUZZLE



I was initiated into the mysteries of "cinch" in the cardroom of the steamship Bacteria. I lost the first game to Baron von D. and Count de C., who each won enough to double their stacks of chips. The baron and I scored the second game, thereby doubling our assets. Then the

count and I won the third game, which doubled our chips. The mysterious feature of the situation was that each player had won twice and lost only once, each then having the same number of chips, although I had lost \$100.

How much money did I start with?

Evolution Puzzle.

Evolution puzzles are very interesting, and the young folks should practice with them more than they do to learn to originate ideas of their own. How would you change a cat into a dog, one letter at a time, by introducing new subjects? Cat, cat, dot, dog, and there you are in three moves.

A Pictorial Charade



Can you tell what kind of a weight this is?

A Charade.

My first when in a circle found,
 Betakes to whirling round and round;
 My second, elevated high,
 Calmly surveys the passerby;
 My friendly whole acts like a brother,
 Not for himself, but for another.
 Cipher Answer.—19, 16, 15, 11, 5, 19, 13, 1, 14.

THE JUGGLER



PROPOSITION---Cut one of the triangles in half and then fit the six pieces into a perfect square.



HERE IS A PRETTY trick version of an old-style puzzle, which while quite simple, will amply repay all who study out the principle upon which it is based.

The clown after juggling with the five triangular pieces of cardboard to attract attention, proceeds to cut one of them into two pieces.

He then lays the six pieces upon the top of the box and shows that they will fit together and form a perfect square.

The pieces represent five right-angled triangles, say one inch high by two inches on the base, so you can readily cut five similar pieces from paper and then guess how to cut one of them so that the six pieces will form a perfect square.

The Miller's Problem.

A miller took one-tenth of the meal or flour he grinds for "toll." How much did he grind if the customer had just one bushel after the toll had been taken?

Why was "Uncle Tom's Cabin" not written by a woman's hand? Because it was written by Mrs. Beecher Stowe (Beecher's toe).

What moral lesson does the weather cock teach? It is vane to a-spire.

When is a house like a bird? When it has wings.

Why is a lame dog like a school boy adding six and seven together? Because the dog puts down three and carries one.

When is a lawyer like a beast of burden? When drawing a conveyance.

Why is a coward like a leaky barrel? Because they both run.

If a short man married a widow, what will his friends call him? A widow's mite.

Who is privileged to sit before the Queen with his hat on? Her coachman.

Why is it unjust to blame coachmen for cheating us? Because we call them to take us in.

What is a counter-irritant? A fashionable woman shopping.

When was paper money first mentioned in the Bible? When the dove brought the green back to Noah.

Which is the easier profession, a doctor's or a clergyman's? A clergyman's: he preaches, the doctor practices.

When does water resemble a cat? When it makes a spiring.

THE BUILDING OF
SOLOMON'S TEMPLE
 A PROBLEM BY
SAM LOYD.

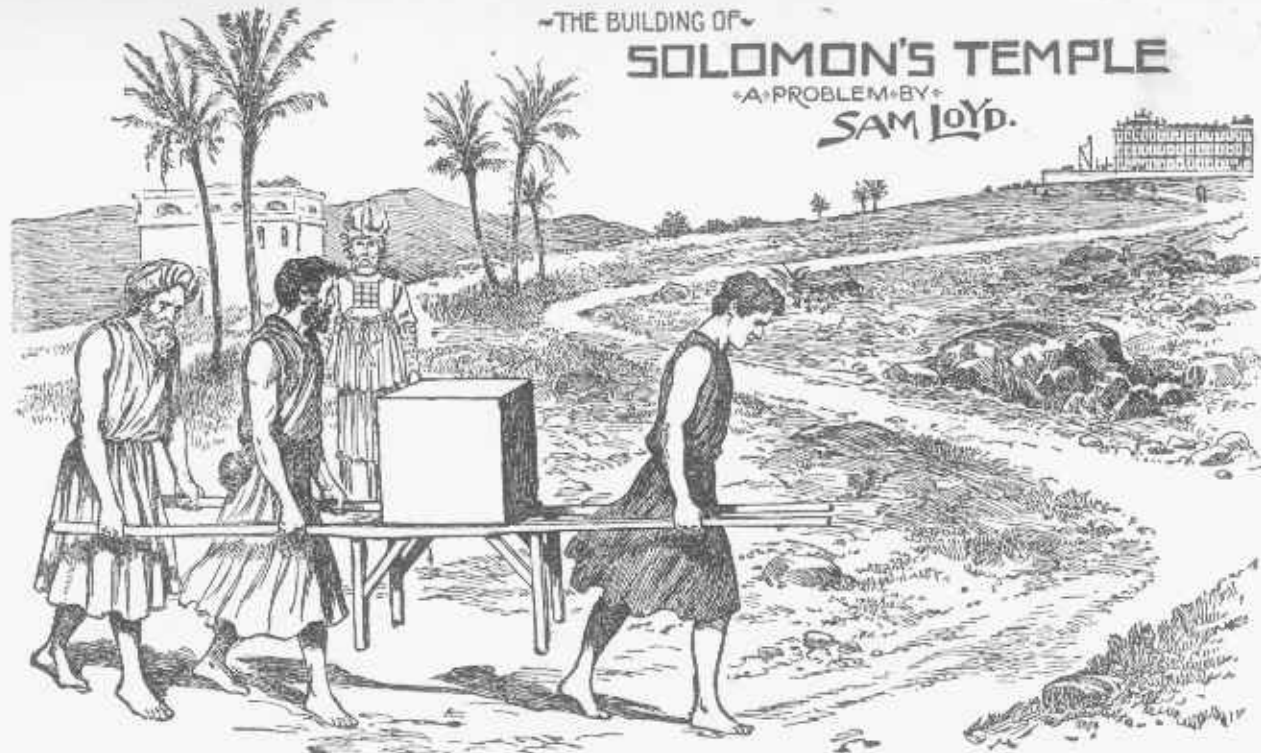

ACCORDING to tradition and biblical lore, Solomon's Temple, the most remarkable building ever constructed, was built on Mt. Moriah, in Jerusalem, and was so cunningly or skilfully designed by the architects and craftsmen, that the immense edifice in all its parts and details was put together without the slightest noise from hammer, saw or chisel.

Every stone was finished at the quarry, so perfect in its proportions and measurements that it could be fitted into its proper position without the use of implements or the creation of any noise whatever. The blocks of finished marble, some of immense size, were drawn by teams of oxen to a point just outside of the radius of a mile from the site of the temple, and from that point they had to be carried by hand up an inclined roadway, which raised them 880 yards higher, to the level of the plane of the temple.

As the body of the temple was built with blocks of marble one cubit (viz.: 18 inches) square, it is an easy matter to compute that those square blocks would weigh 632 pounds each, which speaks well for the strength and endurance of the trained carriers of those days.

Ancient pictures representing the building of the temple, show that

these building blocks were carried by three men, as shown in the sketch, and if the ancients were so exact and scientific in this particular, as they proved to be in the assembling of the many parts, it would involve a pretty puzzle, well worth a moment's consideration.

I give the problem as I found it, with the front man grasping the handles of the carriers thirty-six inches ahead of the block of marble, and I ask you to locate the correct distance for the two men in the rear, so that the weight of the stone will be divided equally between the three men.

The old picture from which I glean the problem, gave the correct positions of the three men, and was so suggestive of a problem, that every one with puzzle proclivities could not resist the temptation of making a mental calculation to determine whether the weight was evenly distributed, but to conceal whatever difficulty the puzzle may possess, I have changed their positions, so that as now shown it is a little hard on the head man.

A Charade.

My first a kind of wing no aid to birds I lend;
 My next a beverage; my whole we'll call the end.

Cipher Answer.—6, 9, 14, 1, 12, 5.

A Riddle.

My first and my second, their faith truly plighted,
 As man and his wife were fondly united;
 My second (like wife) on my first quite depended,
 At his useful vocation she always attended;
 As a whole they are perfect, both skillful and clever,
 While alone each is useless, so join them together.

Cipher Answer.—20, 8, 18, 5, 1, 4, 1, 14, 4, 14, 5, 5, 4, 12, 5.

Buried Proverb.

In each of the following sentences a word is concealed. When the words are rightly guessed, and read in the order here given, they will form a familiar proverb:

1. A naughty cat ran away. 2. They found a closely written roll in gathering up the rubbish. 3. It is the best one that I have ever seen. 4. The rug at her stairway is not a valuable one. 5. He is an old acquaintance of mine. 6. Amos soon saw through the stratagem.

A Rebus.

Allow my first and third to meet,
 They form a noble ranger,
 My second panders to deceit,
 And in my whole there's danger.

INFANTRY DRILL.

PRIZE PUZZLE

BY SAM LOYD



The Infantry Drill.

Here is a lesson in military tactics which goes to show that General Cinch, like the great Napoleon, exhibited a precocious genius for the art of war at a very early age. Before he reached his tenth year he drilled a company of street urchins in the manual of arms, and originated the famous "two by two march," which is so puzzling to military students. The company is supposed to be standing at present arms, with a boy and a girl alternately on the line. Wishing to separate the soldiers from the red cross lassies by moving two adjacent persons at a time, he calls them by name, as indicated by the letters on their hats, always moving two adjacent persons at a time, so that in four moves, still standing close together, the boys are separated from the girls in just four moves, of four couples.

A Charade.

My modest first would ne'er aspire
 To rise above an equal,
 To pity of my next has claim,
 A safeguard in the sequel.

A Rebus.

Take a number and repeat it,
 Add another to complete it,
 And then I think you'll quickly know
 That I am neither dull nor slow.

A Charade.

The troop arranged for battle,
 Without my first would fly,
 And whether good or bad,
 Without it you would die.
 Go seek the earth and ocean,
 For smallest things you guess;
 Yes, bring the atom from the air,
 And still my second's less.
 The traitor, when condemned to die,
 May calm his cares and pray;
 Yet when the axe sounds "dust to dust,"

My whole he's borne away.
 Cipher Answer.—8, 5, 1, 4, 12, 5, 19, 19.

Why is a cart-horse always in the wrong place?
 Because you have put the cart before the horse.

What has many leaves but no stem?
 A book.
 What two letters make a prophet?
 C. R.

Mr. Funnyman's Joke.

"Say, Algy," said Mrs. Funnyman, of London, "tell me the smallest amount of money above three cents that cannot be represented by four American coins?"

Algy gave it up, as it is a hard little puzzle, but he resolved to get square with Mrs. Algy, so just before starting for his office he said: "By the way, dear, have a look at

the dates of your coppers now and again; our exchange clerk told me yesterday that 1860 pennies would fetch over seven pounds just now in London."

"Really! Who'd have believed that now?" replied Mrs. Funnyman. "I'll just go through all mine this very morning." And as Algy closed the door he chuckled. "Got her that time," said he.

When he reached home the same evening he found Mrs. Funnyman in front of her mirror, trying on a dainty Paris creation in hats, while a lovely jacket lay over the back of a chair.

"Who's left us a fortune this time, Puss?" said he.

"Oh," said Puss, in ecstasy, "I found two 1860 pennies to-day, love; that meant over fourteen pounds, so I knew you would not object to my getting a few—" But here the paleness of Funnyman's face brought her to a pause.

"Whatever's the matter, Algie?" said she.

"Jerusalem, woman!" he shouted. "Whoever heard such moonstruck nonsense? Can't any idiot see that 1860 pennies at twelve a shilling are worth over seven pounds?" And here speech failed him.

He always explains his little jokes now.

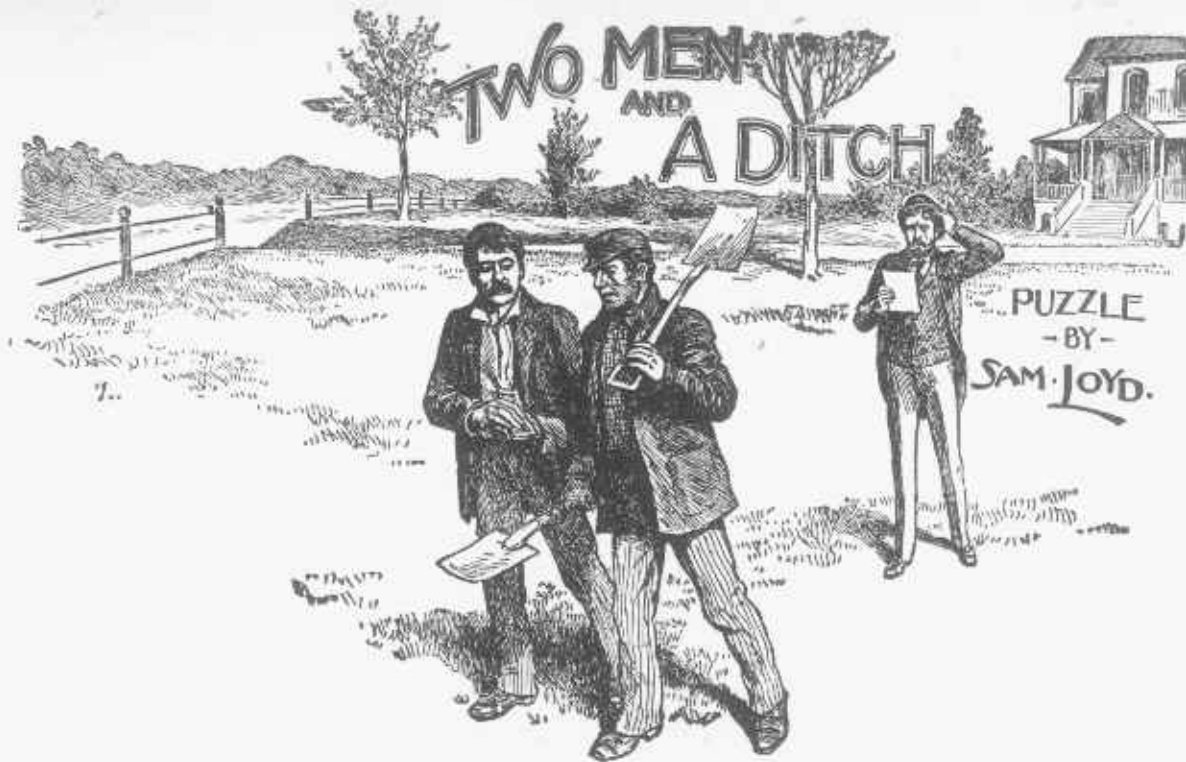

PROPOSITION—Show how the men should divide their money.

WE GIVE OUR PUZZLISTS one of these natural problems based upon the accidental development of ordinary affairs, which are periodically springing upon the public, and which go the rounds of the press challenging a reasonable explanation or solution. It is safe to say that the problem, in one form or another, has reached me from a score of noted puzzlists and mathematicians, all of whom question its correctness for the reason that they are led to look for a deeper proposition than pertains to the problem, whereas it is a simple little incident in "hire mathematics," which the laborers could readily solve for themselves:

A gentleman engaged two workmen to dig a driveway from a new house he was building to the road, distant from his door just one hundred yards. He agreed to pay one hundred dollars for the job, so it made no difference to him how the men divided the money. The men did not work continuously so as to charge for their time. They worked from opposite ends of the road and estimated according to work done per running yard. The man who worked from the house end had a larger distance to wheel the dirt, but did not have to remove so much as did the man working at

the other end, so he agreed to take 90 cents per running yard for what he did. The man working in from the road had more earth to remove, so it was agreed that he should have \$1.10 per running yard for his work.

When the road was finished, they estimated their work according to agreement and found that each man was entitled to fifty dollars, so they divided the hundred dollars evenly, and went on their way rejoicing. They saw no difficulty in the settlement, and did not even suspect that there was opportunity for dispute, or introduction of a complex problem.

The owner of the house, however, who was a noted professor of mathematics, called them back and showed that the money should not be divided in that way. He explained the impossibility of figuring out how much work each man had done at the price agreed upon, to earn an equal amount of money, and evolved therefrom a complicated state of affairs which made both of the men dissatisfied. The carpenters, masons and plumbers struck out of sympathy, so that the house was not completed in two years.

Can you show how much work each man did to receive the same amount of money.?

Why is a blush like a young lady? Because it becomes a young woman.

PUZZLE
- BY -
SAM LOYD.

A CHARADE.

My first is seen in every line,
And may be found of course in mine;
My second howsoever near,
You cannot see, but often hear;
While by my whole the man of trade,
Has information well conveyed.
Cypher Ans. 9, 14, 12, 15, 9, 3, 5.

A REBUS.

My whole, kind puzzlers you will find,
Designates the female kind;
Behead, and then you'll plainly see
The sex entirely changed will be;
Decapitate once more, and then
The female sex appears again.
Cypher Ans. 13, 1, 4, 1, 13.

ENIGMA.

Though they catch me with a hook,
I'm more allied to bird than beast,
In form more like a snake I look,
Though having sixteen feet at least!
Cypher Ans. 16, 5, 18, 3, 8.

A CHARADE.

My second takes my first
As first she leaves her nest.
My whole a holy name you'll find
Among the martyrs blest,
Cypher Ans. 19, 20, 5, 1, 8, 5, 14, 6.

Which tree commands the most respect from its fellows? The elder.



PROPOSITION—Show how to change the fifteen stripes into thirteen.



HERE IS A PRETTY puzzle, built upon an incident of the late Spanish-American war, wherein a blockade-runner was captured, which had displayed an American flag containing fifteen stripes.

It is not generally known that our flag originally had thirteen stripes, but, according to the "Congressional Journal," January 7, 1794, a resolution was introduced to add two stripes and two stars, because Vermont and Kentucky had come into the Union. Mr. Goodhue, of Massachusetts, thought it "a trifling business which ought not to engross the attention of the house."

Mr. Lyman, also of Massachusetts, retorted that it was "of the greatest importance not to offend the new states."

Mr. Thatcher, of Massachusetts, branded it as "a consummate specimen of frivolity."

Mr. Greenup, of Kentucky, considered it "of very great importance to inform the rest of the world that we now have two additional States."

At the suggestion, however, of Mr. Boudinot, of New Jersey, who thought Vermont and Kentucky ought to be kept in good humor, the bill was passed. On January

13, 1794, it was ordered that from and after May 1, 1795, the flag should have fifteen stripes and fifteen stars.

Twenty-three years later, in December, 1817, Mr. Wendover, of New York, had the following resolution passed:

"Be it enacted, that from and after the 4th of July next, the flag of the United States shall be thirteen horizontal stripes, alternate red and white, and that the Union be twenty stars—white in a blue field, and that, on the admission of a new State into the Union, one star be added to the Union, of the flag; and that such addition shall take effect on the 4th day of July next succeeding such admission."

The puzzle to which attention is called, turns upon the converting of a fifteen-striped flag into one of thirteen, without any waste of material. Show how to divide the flag into the fewest possible number of pieces which will fit together so as to make a flag of thirteen stripes.

Why is a cock-eye like a note of interrogation? Because it is a queer eye.

What is enough for one, too much for two, and nothing at all for three? A Secret.

What bird might be called a chicken thief? A cock robin.

What did Job's wardrobe consist of? Three wretched comforters.

When is a sailor not a sailor? When he is aboard.

Why is a farmer like a potatoe? He depends on the plough.

What word deprived of a letter makes you sick? M-usick.

In which month do ladies gossip the least? February.

What are the most seasonable clothes? Pepper and salt.

Which are the most peppery letters of the alphabet? KN (Cayenne.)

When would you welcome a blow from a lady? When she strikes you agreeably.

When is the pudding inhabited? When it has a little Indian in it.

What kind of leather would a naked Moor remind you of? No! not undressed kids, but undressed morocco.

Why is a French franc of no value compared with the American dollar? Because it is worth-less.

Why are people with short memories covetous? Because they are always for-getting something.

Why are pigs more intelligent than human beings? They nose (knows) more.

Rip Van Winkle Puzzle

BY Sam Loyd



Rip Van Winkle Puzzle.

The old Dutch game of Kugelspiel, from which the modern ten pin alley was derived, used to be played with thirteen pins placed in a row, so that only one or two pins could be knocked out at one shot. The bowlers stood so close to the pins that it did not call for much skill to hit any single pin, or two adjacent ones, which the player desired to knock down. At first it would look as if it made no difference whether one or two pins got knocked down, for the players bowled alternately, one ball at a time, and the point of the game was to see who could knock down the last pin.

It is assumed that they played with such skill that any desired pin could be hit at will, for, according to the old rules, a player loses if he scores a single miss. Supposing, therefore, that a player can hit any single pin or any two adjacent ones he wishes and that they play turn about, one ball at a time, who can solve the problem that now confronts Rip Van Winkle?

The little Man-of-the-Mountain with whom he is playing has just rolled a ball and knocked out pin No. 2. Rip has the choice of twenty-two

different plays, any one of the twelve single pins, or any one of the ten middle spots which will bring down two pins. Which is his best shot to win the game? It is assumed that the game is continued to the end, with the best possible play on both sides.

It will be found to be a very pretty problem in ten pins.

Twenty-two Birds Expressed Enigmatically

(1) A bird full of frolic and fun, (2) the standard old Romans adored; (3) the bird that sad judges put on, and (4) the bird that from Eden hath soared. (5) A bird that must help you to dine, and (6) a bird that is useful in chess; (7) a bird made of paper and twine, and (8) a bird in mourning dress. (9) The bird that must be in a fleet, and (10) one raising a ponderous load; (11) the bird that supplies us with meat, and (12) the name of an iron road. (13) A bird that mimics and apes, and (14) a food the Chinese eat. (15) A bird that helps to make clothes for men, (16) the bird that oft sells from door to door; (17) the bird that can write with a pen, and (18) the name of a foreign shore. (19) The bird that in

ages past was the scourge of imperious Spain, (20) the bird that should travel fast, and (21) one with a shallow brain. (22) The readers may often have heard of many a wonderful nest, but tell me the name of the bird that built of our churches the best.

A Study in Palmistry.

Inform a young man that you will tell him the name of his future wife by reading the lines of his palm.

Ask him the name of his father and mother, and also his full name, so that you may count the number of letters. (He says John Henry Smith.) Then, after asking him numerous embarrassing questions regarding how many times he has been in love, whether he could support a wife, how many times he has been rejected, etc., tell him that the name of his future wife will be Mrs. John Henry Smith.

A Rebus.

An animal tired of his kind,
Being just inclined to go astray;
One slightly changed came up behind,
And surely then it flew away

Why is A like Honeysuckle?	Why is B placed before C?	Why is C like a Schoolmaam?	Why is D like a Squalling child?	Why is E like London?
Why is F like a Fish hook?	Why is G like a Hot day?	Why is H good for Deafness?	Why is I the lucky vowel?	Why is J like Your nose?
Why is K like a Pig's tail?	Why is L like a Queen?	Why is M a favorite with miners?	Why is N like a pig?	Why is O like a Horse?
Why is P a false Friend?	Why is Q like a Guide?	Why is R like a Winner?	Why is S like a fittled lady?	Why is T like an Island?
Why is U not so Queer as I?	Why is V always Spooky?	Why is W like a scandal?	Why is X a Mystery?	Why is Y a Great Day?



Let the young folks exercise their minds with conundrums and riddle if you would have them grow bright and companionable. Nothing sharpens the wits and teaches one the hidden meaning of words like guessing conundrums. The process of composing or answering conundrums develops the imagination and strengthens the mental powers. Harry has prepared a set of conundrums upon the letters of the alphabet for the benefit of his young friends; see how many of the questions you can answer correctly.

I received the following communication the other day from a young puzzlist:

Missed her—trees being at the of king of terrors, 10 mills for his quakers, and who, which and what. They odor for Dr. Juvenile Humanity (who)—2 Dr. Haypreservers, and little devil behold scarlet his assistance; but B4 he arrived the not legally good changed color.

Here is the intended translation: Mr. Dashwood, being at the point of death, sent for his friends and relatives. They sent for Dr. Childs,

who inclosed a few lines to Dr. Barnes and imp-lo-red his assistance. But before he arrived the invalid died.

Arithmetical Paradox.

I am a word of five letters. Multiply my fifth by two and you have my first. Divide my first by twenty and you have my third. Divide my third by five and you have my second and fourth.

Cipher Answer.—3, 9, 22, 9, 12.

A Rebus.

I'm an honored lady in the land,
And though I'm dignified and grand,
I'm sure ten thousand times a year
As many people call me dear;
Behead me and bowed down with years

Your oldest relative appears,
Behead again, and till her death
A fonder mother ne'er drew breath,
Behead again, but leave a leg,
For cockneys like me with an egg,
Behead once more, and strange to see
A thousand things are found in me,
Now reconstruct you'll find my name,
Backward and forward reads the same.

Cipher Answer.—13, 1, 4, 1, 13.

Alphabetical Addition.

To substitute numbers for letters.

B O W
A P P L E
C H O P S
H A S H E S
C H E E S E
A P P L E S
"E H W"

P A L E A L E

Alphabetical Addition.

B
L A Y
T E N
D O Z
D N L L

Evolution Puzzle.

Convert *fade* into *silk* in five changes, substituting one letter at a time and always forming correct words.

A Charade.

The first of equal value,
The second to decay
The whole a very noisy bird
From South America.



PROPOSITION—How many words end with cion?

IN RESPONSE TO A highly complimentary letter from a lady who says that her children take such interest in my puzzles, and who suggests that a few good word-puzzles would be instructive, if built upon a plan which would induce the scholars to study their books, we will inaugurate a little chase through the dictionary.

If space was not somewhat limited I should like to tell about the disappointing experience of a party of prospecting miners who staked out a town and christened it "Dictionary," because, as they believed, that the dictionary was "the only place where peace, prosperity and happiness could be found." But they discovered by bitter experience that anything and everything can also be found in that same dictionary, so it was the things that they were not looking for which turned up.

Just to show how elusive some things which we want may be even in the dictionary, no matter how

simple they are, try to help Henry out of a little quandary which befell him the other night in a dream. He thought he was passing through some woods on his way to school, when he met a wise owl, who took his dictionary, and to give him something easy, said: "Just name me a few words ending with cion."

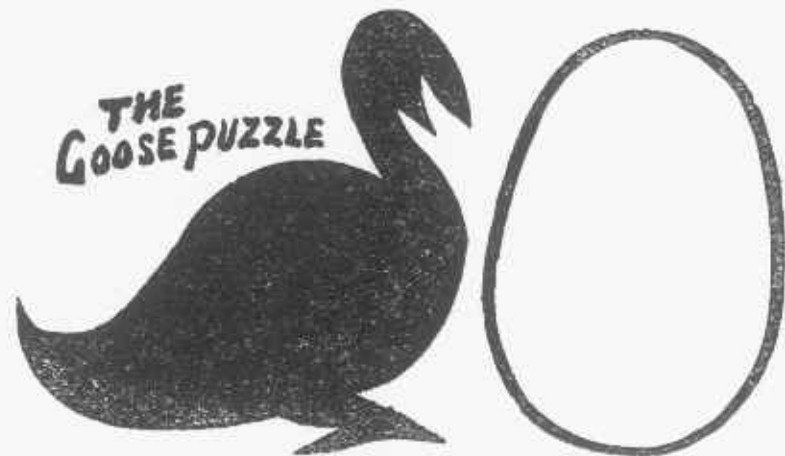

Harry was completely nonplussed, and asks our young puzzlists to help him out by suggesting a few words.

What is the difference between a photographer and the whooping-cough? The one makes fac-similes, the other sick families.

What is the difference between 100 and 1,000? O (naught).

Why should a ship's officer never put his chronometer under his pillow? Because he should never sleep upon his watch.

Which are the most contented birds? Crows, because they never complain without caws.

What author would eye-glasses and spectacles mention to the world if they could only speak? You see by us (Eusebius).

What is the difference between a hen and an idle musician? One lays at pleasure, the other plays at leisure.

What's the difference between your last will and testament and a man who has eaten as much as he can? One is signed and dated, the other dined and sated.

Why is a mouse like hay? Because the cat'll (cattle) eat it.

THE GOOSE PUZZLE.

Of course you have heard of the philosophical goose who worried herself until she grew black in the face in trying to solve the evolutionary problem as to whether the original egg came from a goose or the goose from an egg. Well, in this case you are to show that the goose can be cut into just three pieces which will fill the egg, and as the egg cannot be divided so as to make a goose of anybody, it is supposed to throw some light upon the vexed question.

THE 14-15 PUZZLE IN PUZZLELAND



The older inhabitants of Puzzleland will remember how in the early seventies I drove the entire world crazy over a little box of movable blocks which became known as the "14-15 Puzzle." The fifteen blocks were arranged in the square box in regular order, only with the 14 and 15 reversed, as shown in the above illustration. The puzzle consisted in moving the blocks about, one at a time, so as to bring them back to the present position in every respect except that the error in the 14 and 15 must be corrected.

A prize of \$1,000, which was offered for the first correct solution to the problem, has never been claimed, although there are thousands of persons who say they performed the required feat.

People became infatuated with the puzzle and ludicrous tales are told of shopkeepers who neglected to open their stores; of a distinguished clergyman who stood under a street lamp all through a wintry night trying to recall the way he had performed the feat. The mysterious feature of the puzzle is that no one seems to be able to recall the sequence of moves whereby they feel sure they succeeded in solving the puzzle. Pilots are said to have wrecked their ships, engineers rush their trains past stations and business generally became demoralized. A famous Baltimore editor tells how

he went for his noon lunch and was discovered by his frantic staff long past midnight pushing little pieces of pie around on a plate! Farmers are known to have deserted their plows and I have taken one of such instances as an illustration for the sketch.

Several new problems developed from the original puzzle which are worth giving:

Second Problem—Start again with the blocks as in Fig. 1 and move them so as to get the numbers in regular order, but with the vacant square at upper left-hand corner instead of lower right-hand corner; see Fig. 2.

Third Problem—Start with Fig. 1, turn the box a quarter way round and so move the blocks that they will rest as in Fig. 3.

Fourth Problem—This is to move the pieces about until they form a "magic square," so that the numbers will add up thirty in ten different directions.

Fig 2.

	1	2	3				
4	5	6	7	1	2	3	4
8	9	10	11	5	6	7	8
12	13	14	15	9	10	11	12
				13	14	15	

Fig 3.

The Picnic Puzzle.

When they started off on the great annual picnic every wagon in town was pressed into service. Half way to the grounds ten wagons broke down, so it was necessary for each of the remaining wagons to carry one more person.

When they started for home it was discovered that fifteen more wagons were out of commission, so on the return trip there were three persons more in each wagon than when they started out in the morning.

Now who can tell how many people attended the great annual picnic?

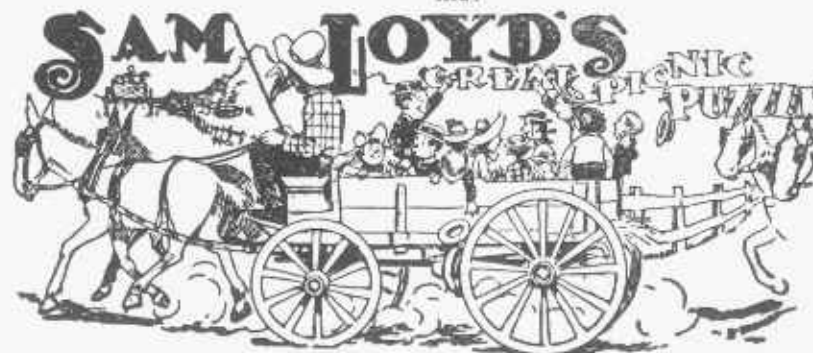



The Japanese jugglers do some stunts which puzzlists are invited to guess. Little Miss Tokio performs her balancing feat upon a ladder, and you are asked to guess how many steps must be taken to go up and down and up, so as to go twice to the top and once again to the ground (as the puzzle starts from the ground) using every step the same number of times. Tommy Riddles says: "Their ain't no catch about this puzzle, it's straight goods, but it's a safe guess that you will go up and down that ladder some before you hit the correct answer!"

In the second act Hiki, the famous swordsman, performs the feat of throwing a watermelon up in the air and cutting it into eight pieces with one stroke of his sword. Tommy says: "Cut out the eight pieces and fit them together before practicing the trick with a live watermelon." Of course the puzzle is merely to fit those eight pieces into a perfect circle.

A Charade.

My first is the Supreme Being, my second a resemblance, and my whole, the highest epithet that can be bestowed upon a hero.

A Charade.

My first is a prayer, or a service divine,
By my next, is a portion of land understood,
My total, alas! you may truly define,
A horrid effusion of innocent blood.

A Charade.

Your heart is heavy, when my first is light;
My second, fools as well as wits can write;
'Twere vain, at first, within my third to try,
For secrets it will tell you by and by.

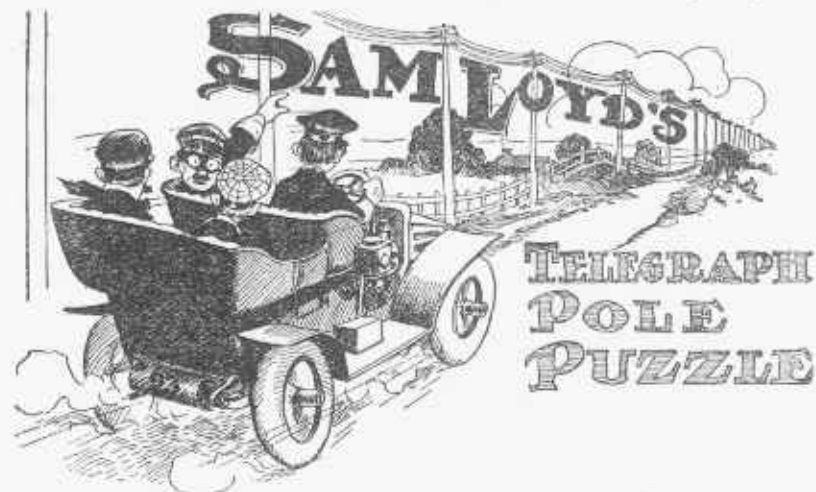

We were coming in the other day from an automobile trip, when we came to a short signal line of three and five-eighths miles of telegraph poles. With the aid of a stop watch I discovered that the average poles

passed per minute, multiplied by the three and five-eighths miles, would give the number of miles per hour that the car was going, and now ask if you can tell how far apart were the poles?

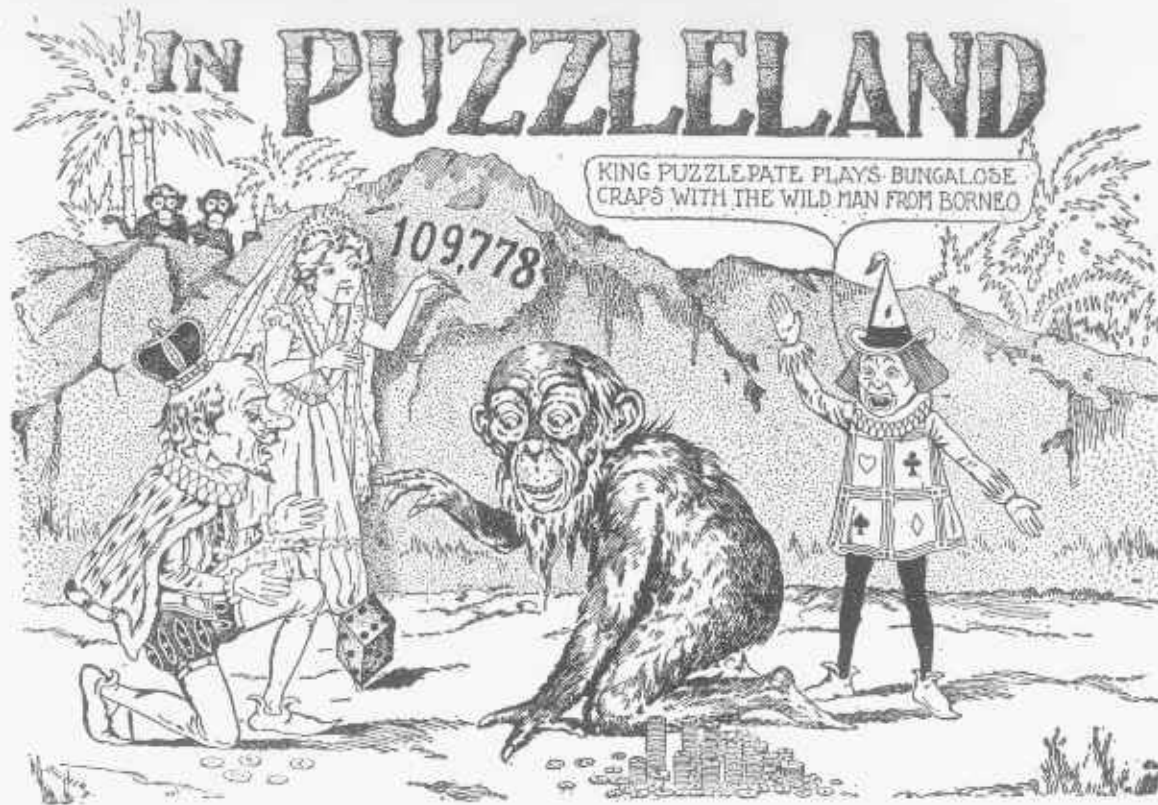

King Puzzlepate is shown to be in hard luck in playing craps with the wild man from Borneo. In the game of Bungalose craps a dice is tossed in the air and the other fellow takes the number which turns up and the choice of any one of the four sides. His opponent takes the total of the other three sides, as the under number is never counted. The game is very simple, although mathematicians differ regarding the exact advantage in favor of the two numbers over the three. In the sketch, the wild man wins this toss by five points and breaks the King's exchequer, so the puzzle is to tell just what number must have turned up to enable a player to score five points! The Princess Enigma is keeping tally, which shows the King to be a heavy loser, but when you see the score translated into Bungalose it will look still larger. The wild men of Borneo, as we all know, have but three fingers on each hand, so they have learned to reckon by the sextimal notation, which does not employ the 7, 8, 9 or 10, as in our decimal system. As a pretty problem, therefore, in elementary arithmetic, we ask our puzzlists to translate 109,778 into the Bungalose notation, so that the wild man who does not know the meaning of the 7, 8, 9 or 10 will know just how many gold pieces he has won.

A Charade.

Ladies, my first you ought to shun,
If you would beauty prize;
And those poor ladies who have none,
May yet be very wise.
My second then I recommend,
Which you may jointly find:
My second's happy to attend
The beauty of the mind.
To you, then, ladies, I compare
My whole as being bright,
For like the beauty of the fair,
It always charms the sight.

A Charade.

My first is as senseless as iron or steel,
But my second is very acute.
The highest sensations it often can feel,
And yet 'tis a part of a brute.
My whole no idea that's brilliant can know,
And from the first hour of its birth,
He scarcely can tell e'en a friend from a foe,
In short, 'tis a mere lump of earth.



Three Texas drovers met on the highway and proceeded to dicker as follows: Says Hank to Jim: "I'll give you six pigs for a hoss; then you'll have twice as many critters in your drove as I will have in mine." Says Duke to Hank: "I'll give you

fourteen sheep for a hoss; then you'll have three times as many critters as I." Says Jim to Duke: "I'll give you four cows for a hoss; then you'll have six times as many critters as I." From these interesting facts can you tell just how many animals there were in the three droves?



King Puzzlepate visits the Darktown Kindergarten and finds that Prof. Johnsing is having trouble with his class of pickaninies, who have taken the liberty of constructing a checkerboard out of the back of his coat! He is ordering the champion of that checker club to patch up the coat or suffer dire consequences. Of course, it is a very simple problem; nevertheless, you, as well as the members of the chess and checker clubs, are invited to assist in the replacing of those eight pieces.

In the second puzzle Tommy Riddles and the Princess have discovered a problem in simple addition on the blackboard, where the figures 1, 2, 3, 4, 5, 6, 7, 8, 9, 0 are represented by the letters A, B, C, D, E, F, G, H, I, J. Can you find out by rule or experiment which letters represent the numbers, so that substituting figures for letters on the blackboard the sum will prove to be correct?

A Charade.

When scudding with a pleasant breeze,
Jack calls my first his friend;
Drinks to my next and is at ease,
Such hours he loves to spend.
But when my first doth chance to fail,
Or otherwise doth prove;
Straight from my whole to furl each sail,
With haste the tar will move.

A Charade.

My first is a term that's distinctive of joy,
For all plans that are form'd it has power to destroy
'Tis fear'd in the palace as well as the cot,
And yet had a hand in the gunpowder plot.
My second of life has been sometimes the bane,
And still has a mighty effect on the brain.
I scarce know what order my whole now must rank
But I yet declare it is nought but a blank.

A Charade.

My first, tho' a small, is a most useful word,
And there's scarcely a page where it has not occur'd.
My next, to the cattle and corn is a guard.
And should it be wanting, they all may be marr'd:
My whole I'd not give, nor would willingly take,
Consider and weigh, it may be a mistake;
For things do not always appear as they are,
And who judges too rashly may fall in a snare.

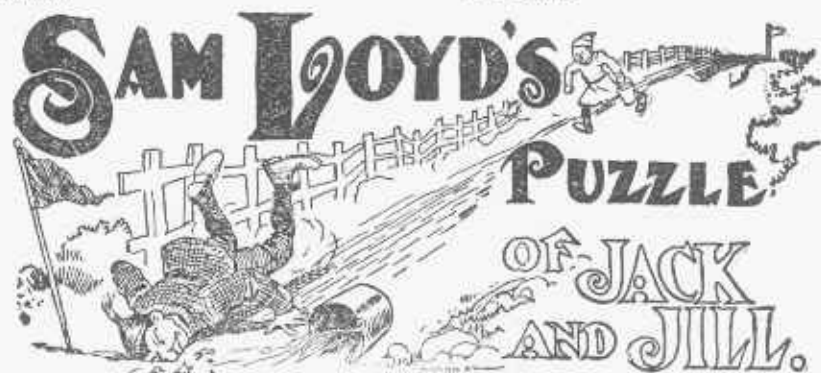

Here is a pretty puzzle from Mother Goose's story of Jack and Jill's race for a pail of water. The distance to the top of the hill was 440 yards, which is just a quarter of a mile. Jack got to the top first and was 20 yards on the return trip

when he met Jill whom he beat home by half a minute. The record of the race is complicated by the runners being able to run down hill one-half again faster than they ran up, so you are asked to figure out Jack's time for the half mile run.



Mathematical professors say that if three cats catch three rats in three minutes, they catch one rat every minute; therefore, "the same three old cats" would catch one hundred rats in one hundred minutes, being just one rat per minute.

This is the correct school teacher's answer, and no other can be given, but the terrible little scholar with the big head wishes to ask the teacher a simple question, just for information:

"If three cats will catch three rats in three minutes, how long would it take them to catch four?" How long would that rat last with three cats after him?

Just take a look at the picture as it was given, and remove the front rats. The teacher says there is nothing stated in the proposition upon which to build a hypothesis regarding the staying qualities of a single rat opposed to three cats. "Then," asks the terrible scholar, "where does it differ from the first proposition of a hundred rats, for after the cats have disposed of ninety-nine rats on schedule time, what will they do to that last rat? One cat kills a rat in three minutes, but how long would it take three cats to kill the same rat?"

Then the terrible scholar asked the teacher: "If a pedestrian with five toes on each foot can walk a mile in eight minutes, how long would it take Ohrlenoff, the Russian, who has eight toes on each foot, to walk the same distance? Of course all good school children are taught to place implicit faith in the maxim that figures never lie, and yet some well-known propositions of the text books are calculated to tax the common sense of any one. It is hardly reasonable to ask a scholar: "If a starving man could devour four loaves of bread in fifteen minutes, how many could he eat in two hours?" and yet the cat and rat problem is very similar.

If three cats will catch three rats in three minutes, how many cats will it take to kill one hundred rats in one hundred minutes?

A Rebus

My whole is always caused by pleasure;
Behold me, then I am a measure;
Take off my head once more, and I am found
In sacred church or edifice renowned.
Cipher Answer.—19, 13, 9, 12, 5.

Worth Their Weight in Gold.



Old Moneybags let it be known that he would endow his daughters with their weight in gold, so they were speedily suited with suitable suitors. They were all married on the same day, and before weighing in partook of some exceedingly heavy wedding cake, which made the grooms very light-hearted.

Collectively, the brides weighed three hundred and ninety-six pounds, but Nellie weighed ten pounds more than Kitty, and Minnie weighed ten pounds more than Nellie. One of the bridegrooms, John Brown, weighed just as much as his bride, while William Jones weighed half again as much as his bride, and Charles Robinson twice as much as his bride. The brides and grooms together weighed half a ton. But you need not bother about the weights of the brides, for the puzzle for you to solve is to tell the full names of the several brides after the wedding.



This odd little puzzle-game, which is played between two persons, playing turn about, with the one counter, is calculated to sharpen the wits and teach you to figure quickly. Place a marker on any one of the numbers shown on the hand, and call out that number (say 5). Your opponent moves it to any other number (say 4), and adding them together calls out 9. Then you go back to 5, and call 14, and so the game goes on until one of them makes exactly 35, and wins. If either is forced to go above 35, she or he will be an old maid or bachelor, as the case may be.

The game can be played very nicely with a ring which is changed from one finger to another alternately by the players as described above, remembering that the thumb always counts 5, the first finger 1, etc. This is an innocent little game played just for fun, not at all like the real game, where the placing of a ring on the third finger may place you under the girl's thumb for the rest of your mortal life!

Now, what is the best number to begin with? As Hamlet says, that is the question.



A Clever Riddle.

Here is a catch, fastened with two screws; can you tell why one screw is just like the other?

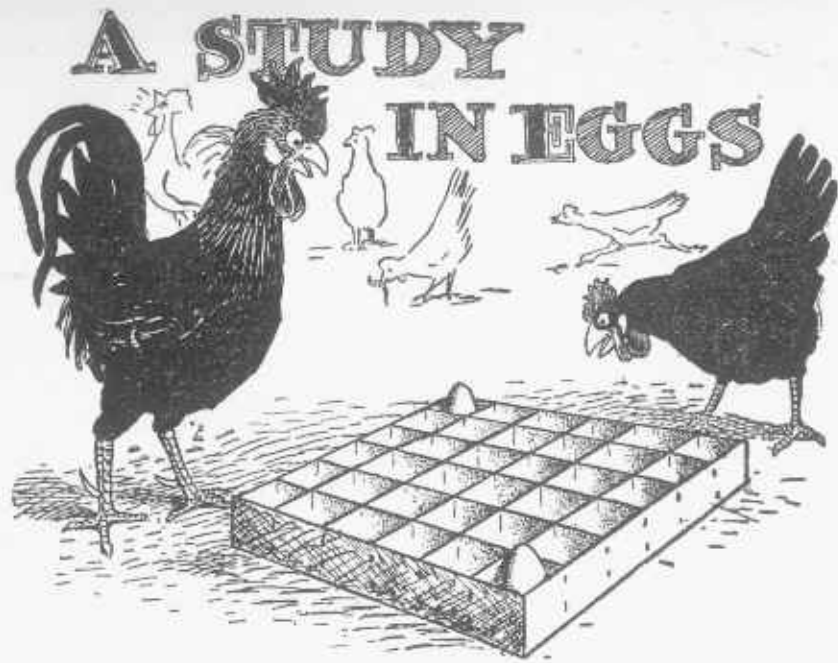

PROF. BURBANKS, who developed the seedless orange and coreless apple, and proved that figs might grow on thistles and that leopards can change their spots by lying down on some other spots has been playing all sorts of pranks with his domestic fowls. He has produced a brand of nestless chickens who are trained to fill up a crate of eggs without the useless intermediary nests, thereby saving the labor of packing and counting.

Each hen keeps account of her own eggs by making it a rule never to lay more than two eggs in line in any possible direction, up and down, right and left, or on the diagonals. This is a very pretty puzzle, which restricts, or sort of unionizes the work of the hens, and betrays a higher intelligence than is developed by the goose, who cannot be taught to perform the feat.

Can you tell how many eggs it is possible to place in the above 6x6 crate without having more than two eggs in a row? We have placed the two first in a row on the bias, as the ladies term it, so you must place no more on that diagonal, but as

"The little black rooster said to his mate,
'Do what you can to fill up the crate.'"

A Rebus
My blooming first comes once a year,
And only once, the mind to cheer;
My next comes with the rising sun,
And dies when his course has run.
My whole is hail'd by old and young
With garland and with festive song.

Cipher Answer.—13, 1, 25, 4, 1, 25.

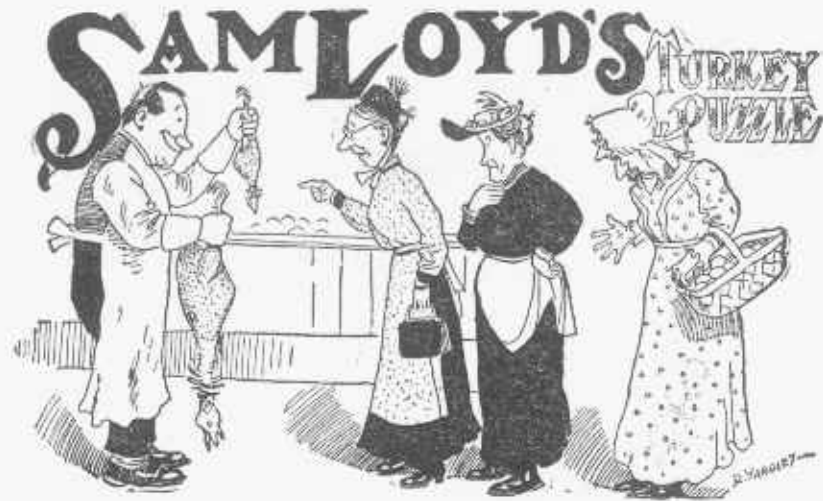

Here is a seasonable problem developed from a chance meeting of two shoppers at the poultry market. Mrs. O'Flaherty explains that she purchased some turkeys at twenty-four cents a pound, and the same weight in geese at eighteen cents a pound. Mrs. Smith tells her that she



I hope it will take you some time to guess this illustrated charade, so that you will remember it all the better.

A Conundrum

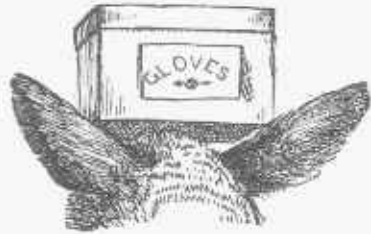

Sammy knew that his sister expected a box of gloves for a birthday present, so he drew the above sketch and asked her if that was what she wanted. When she expressed her satisfaction at the prospect of receiving such an acceptable present, the little brute exclaimed: "All right; I promise to give you a box on the ears."

might have gained two pounds by following the rule given in "Hints to Boarding-house Keepers," which says: "For Christmas divide the money evenly between turkey and goose."

What was the amount of the purchase?

The Architect's Puzzle

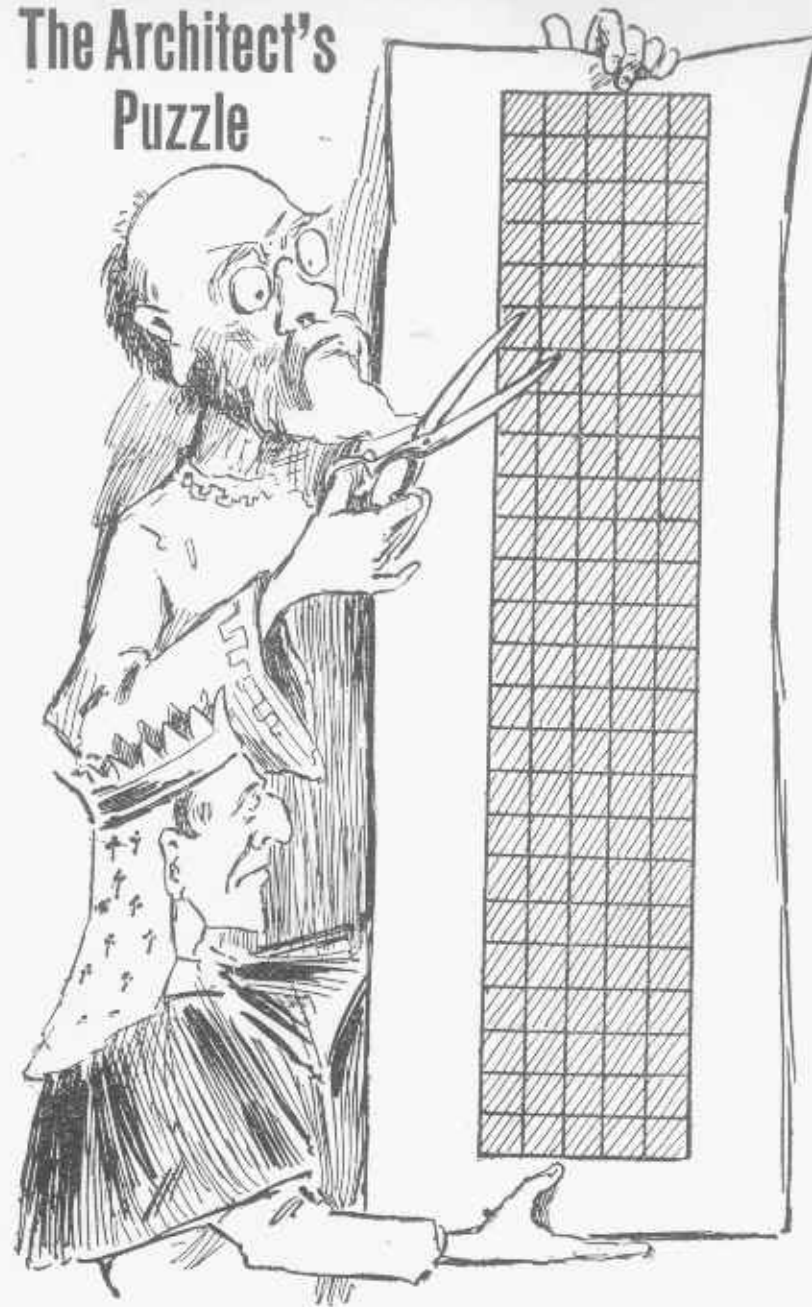

An ancient king once called for his architect and, presenting the ground plan for a new dungeon, stated that he wished to have the plan so modified that the gaoler, who occupied one of the corner cells, could make the rounds of the prison by the most direct route.

The royal architect picked up a pair of scissors and, remarking that he had been familiar with the interior of gaols during his early life, cut the plan in two pieces, which he fitted together, saying, "By this arrangement the same amount of ground is covered, the doors are

placed in the center of the walls of each cell, so as to give an unobstructed view of the entire length of the cells, and an opportunity is afforded of passing through the whole building back to starting point without visiting any cell more than once." Show the improved plan and suggested tour of the warder.

A Charade

My first in half my second, just,
Oh, false and traitorous second;
My total dwell in silent shades,
Purity's emblem reckon'd.
Cipher Answer.—12, 9, 12, 9, 5, 19.

The Canals on Mars



Here is a map of the newly discovered waterways in our nearest neighbor planet, Mars. See if you can make a tour of all of the towns and back to point of beginning without going through any one spot twice. Commence at the south pole from the letter T, spell a complete sentence, using each letter once. The puzzle was sent to a leading magazine, where over fifty thousand correspondents unanimously reported: "There is no possible way," and yet it is a very simple puzzle.

Illustrated Charade.



Here are the names of three New England towns given in pictorial language; can you guess them?

A Rebus

My first is a measure of space,
My second is a part of a tree;
My whole is but half of my first
And is frequently seen when at sea.
Cipher Answer.—25, 1, 18, 4, 1, 18, 13.

MERRY GO ROUND PUZZLE.

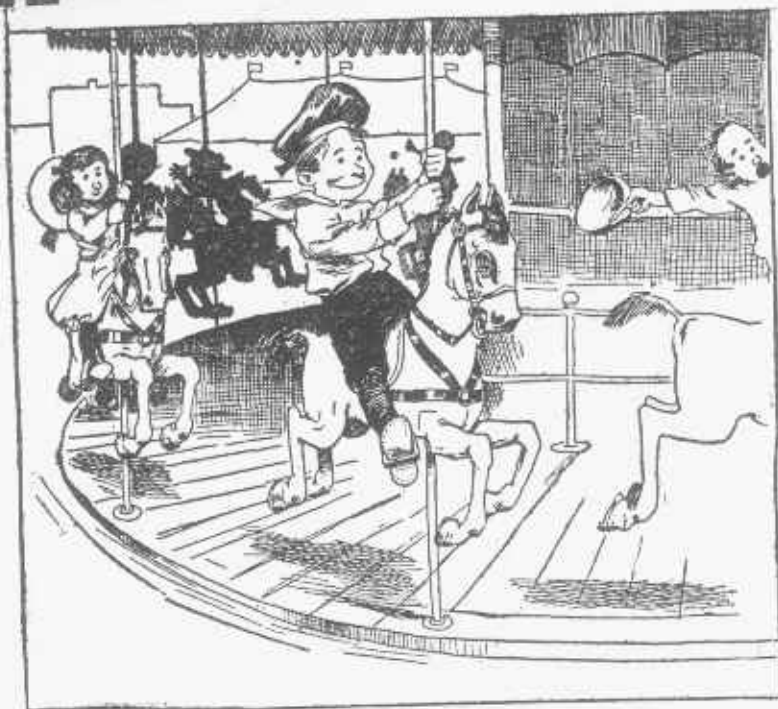

While enjoying a giddy ride at the carousel Sammy propounded a puzzle which reflects much credit to his mental abilities. "One third of the number of kids riding ahead of me, added to three-quarters of those riding behind me gives the correct number of children on this merry-go-round" is the way he puts it; but it will puzzle you quite a little to tell just how many riders there were at this whirligig circus.

A Rebus.

With the Lord of Creation
A vowel combined,
Is no small decoration
To some animal kind;
And the poet's ambition
You'll quickly disclose,
If with all expedition
You rightly transpose.

Deign again to transpose me,
'Tis full worth your while;
For you then will expose me
Detested and vile.
Now the same operation
A third time repeat,
And each one supplication
I render complete.
Cipher Answer.—13, 1, 14, 5.

A Charade
If a squeeze you'll combine with a sign,
A metal you'll have, not found in a mine.
Cipher Answer.—16, 9, 14, 3, 8, 2, 5, 3, 11.

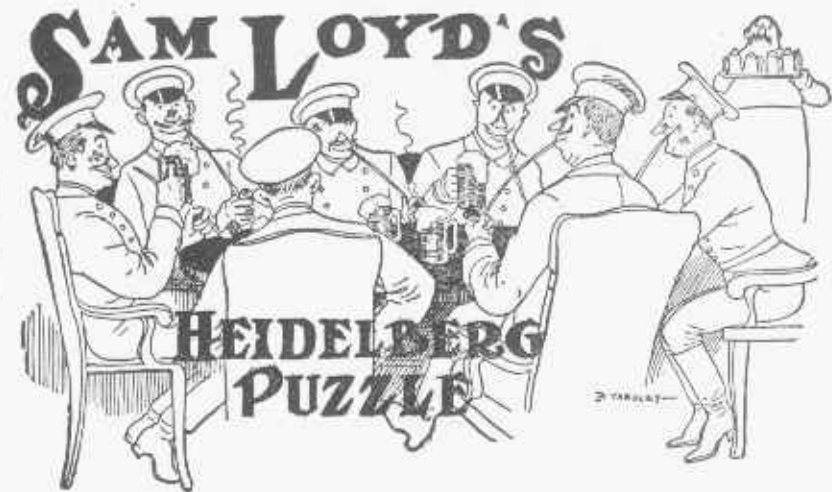

At a recent Heidelberg drinking bout between the Red Caps and the Blues, each student invited all the others to pledge his good health in flowing bumpers of beer. There

The Frenchman's Effort.



Here is one of those happy little incidents which break into the monotony of our hum-drum existence, and proves, as Shakespeare says, that "Life is but a Nickel-in-the-Slot. You may get the Tuti-Fruti, Or you may not."

At the table of Madame O'Flaherty's pension francaise, the Count says to the graceful lady of the house:

"Ah, Madame, I find one of your beautiful rabbits in ze goat!"

It was not a "bon mot," but only the efforts of a foreigner struggling with the difficulties of our language, endeavoring to manufacture conversation. But what did the Count wish to say?

were less than two dozen students present, and yet the Red Caps collectively drank one hundred and eight more steins than the Blue Caps, so you are asked to tell how much beer was consumed altogether.

Sam Loyd's Puzzle of the Old Woman Who Lived in a Shoe.

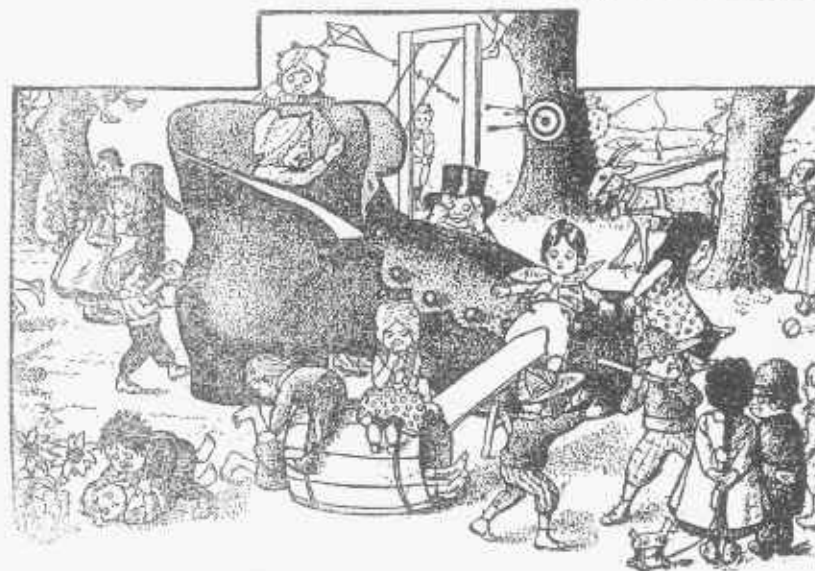

That is all there is to it; whether they got more whipping than bread does not cut any ice in this puzzle. The question is to determine how many children this famous opponent to race-suicide had to pack in her shoe?

Puzzle of the Letter Carrier's Route



This letter-carrier has to serve six city blocks, as shown in the sketch, and he asks if you can guess the shortest route he must take. Begin and end wherever you please, but whenever you turn, turn only to the right and then your answer will be right and you won't be left. Let us say the long blocks are on Avenues A, B and C, while the short ones are

on 1st, 2nd, 3rd and 4th Streets. That will assist you in describing what you suggest as the shortest route for him to take.

Here is another puzzle worth mentioning in connection with this subject. It appears that a valentine was expected from London or Clifton, but the only legible letters on the postmark were ON. Now what would you say were the chances that the letter came from London?

The Dice Game

Although an element of chance enters largely into almost all games, we are continually surprised to find how many persons have no conception whatever of the theory of possibilities. It is not every one who can tell you offhand what are the chances against a penny falling three times in succession with the same side up, or, with four aces turned down on the table, what is the probability of your picking up two cards of a color. Twist the corners of a handkerchief together, and what are the chances for or against drawing two diagonal corners?

I asked a noted sportsman the other day what were the chances in favor of correctly guessing the toss of a penny ten times in succession. He replied that he did not believe that such a thing could happen in a lifetime. And yet, if a little pitch-penny tournament were inaugurated

with 2,048 competitors, the first toss would furnish 1,024 winners, the second 512, the third 256, the fourth 128, the fifth 64, the sixth 32—16—8—4—2, and on the eleventh throw we should have one victor, neither more nor less, who had correctly guessed the toss of a penny ten times in succession.

With these preliminary exercises to show the relationship of chance to the exact sciences, I will relate that I once became stormbound with a party of miners for nearly a month, where our stock of games was limited to a solitary, well-worn die, from which I evolved the following game, which became known as "The Twenty-five Up Puzzle."

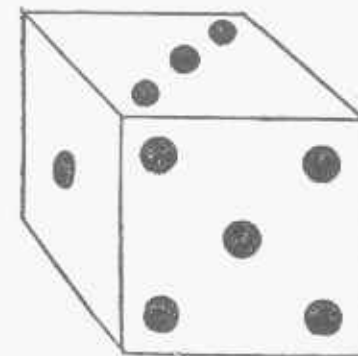

The game is played between two persons, and the object is to see who can get twenty-five first or compel his opponent to carry the score above that point. The first player "sets the pace," as the boys termed it, by calling out any number from one to six. Supposed he commenced the game with 5, the second player then throws the die. Say three turns up; the score adds up eight. The die is no longer thrown now; the element of calculation begins. The first player now rolls the die over, giving it merely a quarter turn, so as to select any one of the four sides, one, two, five or six. Suppose he took six, the score would be fourteen. The next player turns up four, making the score eighteen; the other player turns up six, carrying the total to twenty-four, which will win, as his opponent cannot make twenty-five, and is compelled to go above that figure. The miners believed in lucky numbers, and were ignorant of mathematics. But what I wish to know from a scientific standpoint is this: What is the best number to call first, and wherein is it better than the others?



How close can the young archer come to scoring a total of 100 - using as many arrows as she pleases?

Here is an odd little puzzle which occurred the other day at an archery meeting. The young lady who carried off the first prize scored exactly one hundred points. Can you figure out how many arrows she must have used to accomplish the feat?

The Recess Hour



I note with considerable amusement that when one of our great inventors was asked regarding the study which benefited him most during his school days, he replied that he "picked up the most useful information during recess."

It is safe to say that the fun, sport and exchange of bright ideas between a lot of romping scholars does as much to sharpen the wits and inject vim and go into a boy's character as does arithmetic or geography. We never forget the jokes and tricks of the recess hour, and on the time-honored maxims of "once a puzzlist, always a puzzlist," to pass them along to the second and third generations. I give a little puzzle which comes up with pleasant recollections of the long ago.

A bright lad challenges his classmates to give a figurative answer as to what a fellow should do when he has forgotten his lunch? The "figurative" answer is shown on the

blackboard.

Can you decipher it? I see that he has that famous old puzzle on the blackboard; four squares built with eight marks; change the positions of four of the marks so as to leave but three squares.

It reminds me of Captain Fred Burnaby's experience in an Armenian school as related in his book, "On Horseback Through Asia Minor." He says: "The following day I went to see the Armenian school.

"Perhaps you would like to ask the boys some questions?" said a priest who accompanied me through the building.

"Now, if there is one thing I dis-

like, it is being turned into an examiner, so I hesitated.

"Well," said the priest, a little impatiently, 'they are waiting for you.'

"There was a dead pause, and then I gave the worthy divine the following question: If one man can mow a field in three days, and another man in four, how long will they be doing the work if they are both working together?"

"Come," said the divine, 'you have set them a very easy sum,' and he duly translated it into Armenian.

"It is hardly worth doing," said one of the schoolmasters, 'for, of course, the answer is three and a half.'

"Of course, three and a half," said the priest.

"No," I replied, and I breathed more freely on arriving in the open air, and blessed my old master, who had once set me that catch question, for my reputation as a profound mathematician was established among the schoolboys in Yuzgat."

A Rebus

A dirty, idle race are we,
As sots in us their image see;
But place the head upon the tail,
And when we're advertised for sale,
Let sons of luxury beware!
Distinction speeds a tempting snare.

Cipher Answer.—19, 23, 9, 14, 5.

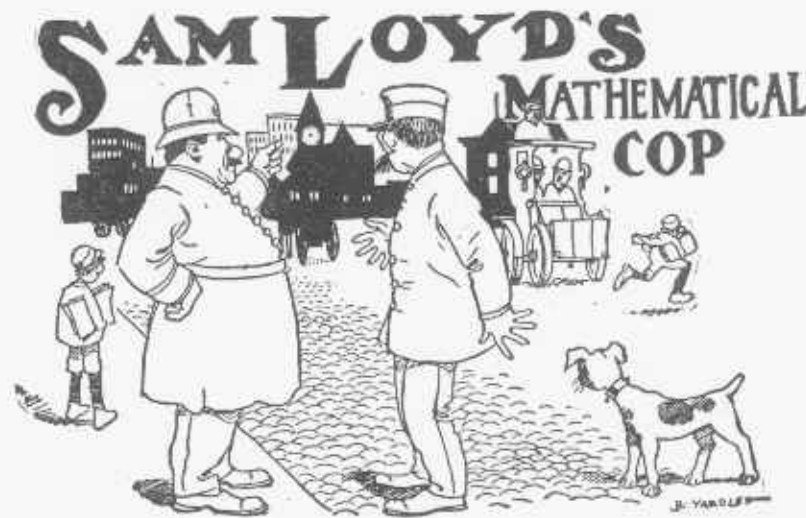

"The top of the mornin' to you; can you tell the time on that clock?" asked McGuire of his friend Clancy, who was known on the force as the mathematical cop. "I can do that same," replied Clancy. "Just add

one quarter the time from midnight till now to half the time from now till midnight, and it will give the correct time."

Can you figure out the exact time when this conversation occurred?

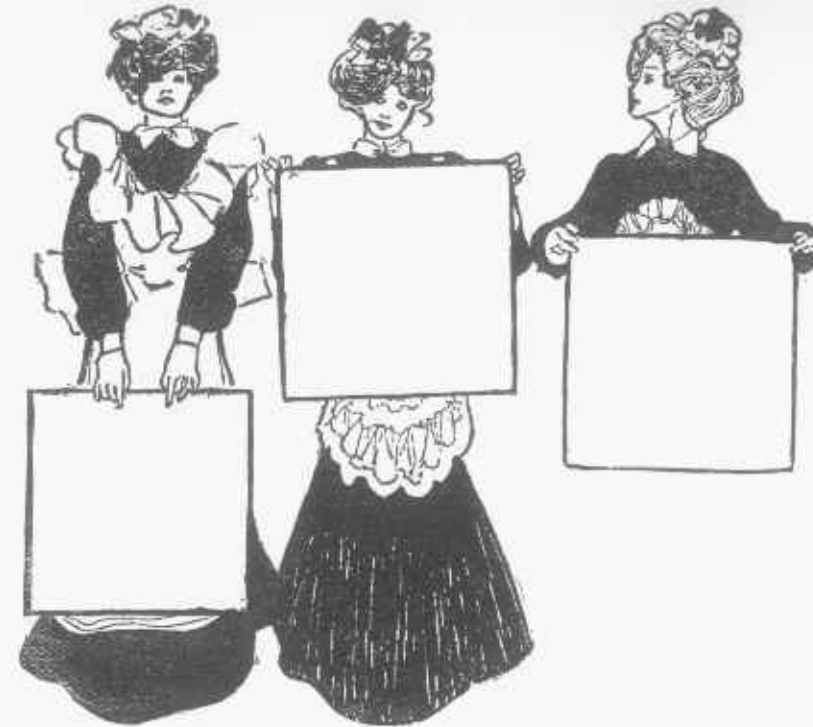

The Three Napkins

"Betsy Ross wasn't so much of a much with her star cutting stunt, I don't think," said the office boy "That trick is so dead easy it gives me a pain. She wouldn't be one, two, three in it with the girls over at the restaurant. Oh my! but ain't they the cut-ups for fair!"

"Here's a puzzle Maggie showed me the other day, that's a puzzle as is a puzzle: Take three napkins, each a foot square; then tell me how big a square table could you cover with those three napkins?"

"There ain't no cutting, just lay them down, lapped or folded, and see how big a square the three will cover. You needn't send anything, just tell me the size of the square and I can tell if you have guessed it all right, all right, and then I'll give you some more."

Twenty-One Palendromes

Originally the term "palindrome" seems to have been applied mainly to sentences that read the same from left to right and from right to left. The ancients were very fond of these verbal tricks and very likely we should be so, too, if the language readily lent itself to them. As a matter of fact, it is very difficult to construct palindrome sentences in

English. One of the very few extant examples is Adam's famous introduction of himself to Eve—"Madam, I'm Adam." Here, however, are twenty-one riddles the answer to each of which is a palindromic word:

1. Dean Swift often speaks of an empress whose name, Read backward or forward, is always the same.
2. The mother of men was a lady whose name, Read backward or forward, is always the same.
3. And Cain took a wife in his exile, whose name, Read backward or forward, is always the same.
4. And of female recluses we know that the name, Read backward or forward, is always the same.
5. When you speak to a lady, you'll find that the name, Read backward or forward, is always the same.
6. When a child, you were dressed in a garment whose name, Read backward or forward, is always the same.
7. Then, too, you were fed on a diet whose name, Read backward or forward, is always the same.

8. You may travel abroad in a carriage whose name, Read backward or forward, is always the same.
9. You may pass o'er a flat piece of country whose name, Read backward or forward, is always the same.
10. When the lamb trots about by a creature whose name, Read backward or forward, is always the same.
11. You may go out and walk at an hour whose name, Read backward or forward, is always the same.
12. You may ride at a time that is later, whose name, Read backward or forward, is always the same.
13. If you shoot off a gun, you'll hear something whose name, Read backward or forward, is always the same.
14. And your dog may hunt well, for no longer his name, Read backward or forward, is always the same.
15. Your bird, too, may sicken of something whose name, Read backward or forward, is always the same.
16. You may quaff of a drink, made of wheat, and its name, Read backward or forward, is always the same.
17. Or stare at a giant, whose little, wee name, Read backward or forward, is always the same.
18. But this you can't do without something whose name, Read backward or forward, is always the same.
19. Whatever your doctrine or dogma, its name, Read backward or forward, is always the same.
20. Do but take a sly look, and of this, too, the name, Read backward or forward, is always the same.
21. Nay, whatever is done, still believe me, its name, Read backward or forward, is always the same.

A Rebus

I'm cold and hard, and aid the bold,
Then take me and transpose;
I'm damp and wet, and still more cold,
The comrade of the snows.
Cipher Answer.—19, 20, 5, 5, 12

The Hardware Store Puzzle



Here is a series of simple rebuses which illustrate articles for sale in a hardware store. Now see if you can correctly name the sixteen articles which the storekeeper has advertised for sale.

Four Kinds of Sound



To convince his mama that sound, like good little children, should be seen but not heard, Sammy drew the above picture, in which he says you can see four kinds of noises! Can you guess what are the four kinds of sounds which are visible?

A Cryptogram

Here is a capital puzzle which will be appreciated by such as in the past have enjoyed presenting their friends

with the time-honored poser of B & D, who, feeling cold, called to his mother, who was in the library reading A ||, "I say, mother, if the B mt put: If the B . putting :." To which the fond mother replied: "How can I put: with such a - der?"

I don't know if I was the first to perpetrate the above, but it has been accredited to me for half a century, so we will assume "the little dark e

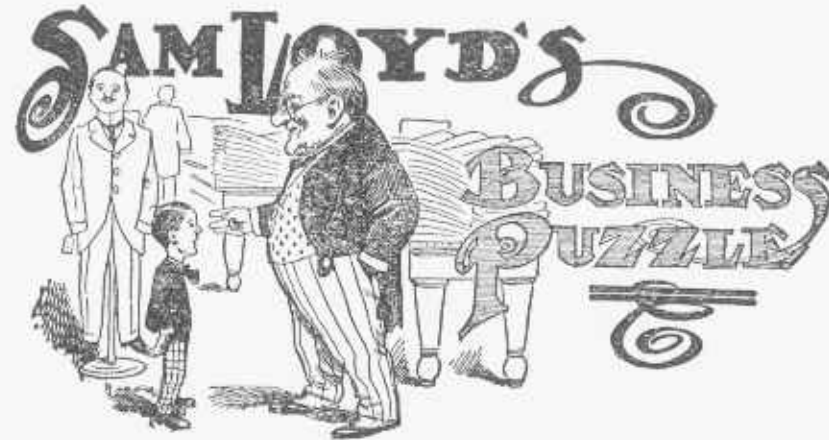

"Johnnie, my boy," said a successful merchant to his little son, "it is not what we pay for things, but what we get for them that makes good business. I gained ten per cent

in bed with nothing over his head" refers to "chestnut" coal when he called to his mother, who was reading "in no sense a broad by mark twain," is: "If the great B mt put colon. If the great B full stop putting colon." To which the smart mother replied: "How can I put colon with such a hyphender?"

But I started out to tell about a most mysterious cryptogram which a young lady pinned upon her friend's wall: you see, she called to take her out to lunch, but after waiting in vain for an hour she pins the following laconic note on the wall and sets out alone.

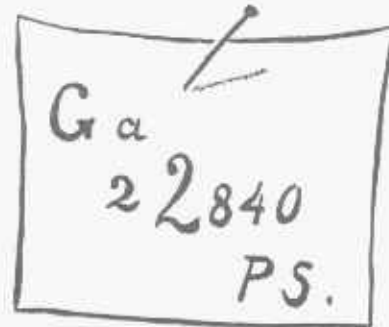

For the benefit of such as do not parlez Francais, I will mention that the first two letters G a convey a little message in French, but the three numerals express her sentiments in good English, while the postscript is a capital joke upon her name, which her friend will readily interpret. This is not an easy problem, but it is one of exceptional interest.

on that fine suit of clothes, while if I had bought it ten per cent cheaper and sold it for twenty per cent profit it would have brought a quarter of a dollar less money. Now, what did I get for that suit?"

IN PUZZLELAND

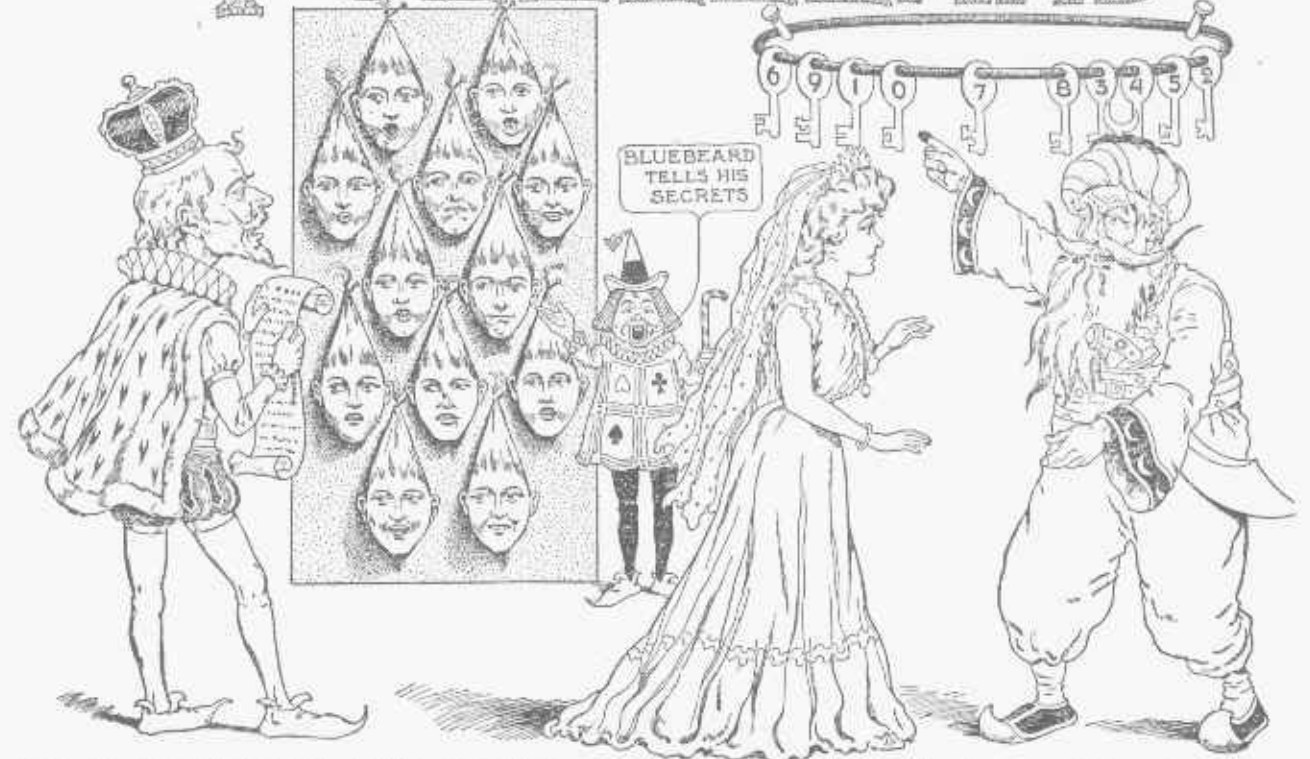

Here is an educational puzzle which, as Tommy Riddles says, "Is apt to astonish every one on account of the ease with which they will perform an incredible feat!" Here are a dozen of Bluebeard's wives, whose names you can actually guess from their mouths! According to the lines of the old fairy tale, when King Puzzlepate asked them their names "they responded with one great voice," etc., "and lived happily ever afterward." Their names were Addie, Ooli, Mary, Fatima, Sallie, Audrine, Edith, Thilbet, Armenia, Shirley, Rose and Louie, (that is a peculiar name; did you ever see four vowels come together before?) Now, if you will study the lips of each while repeating the list of the twelve names, you can readily tell which name each one is beginning to say. It is an interesting lip-reading puzzle which illustrates the manner of teaching the deaf and dumb to carry on a speechless conversation.

In the second act, Bluebeard explains that his bunch of keys was strung upon an endless key ring and divided into three groups so that the first group multiplied by the second equalled the third! That was the secret by which he knew whether the keys had been tampered with and

the keys must have been arranged in three groups so that the first group multiplied by the second makes the third?

Can our clever puzzlists show how

SUBSTITUTION PUZZLE

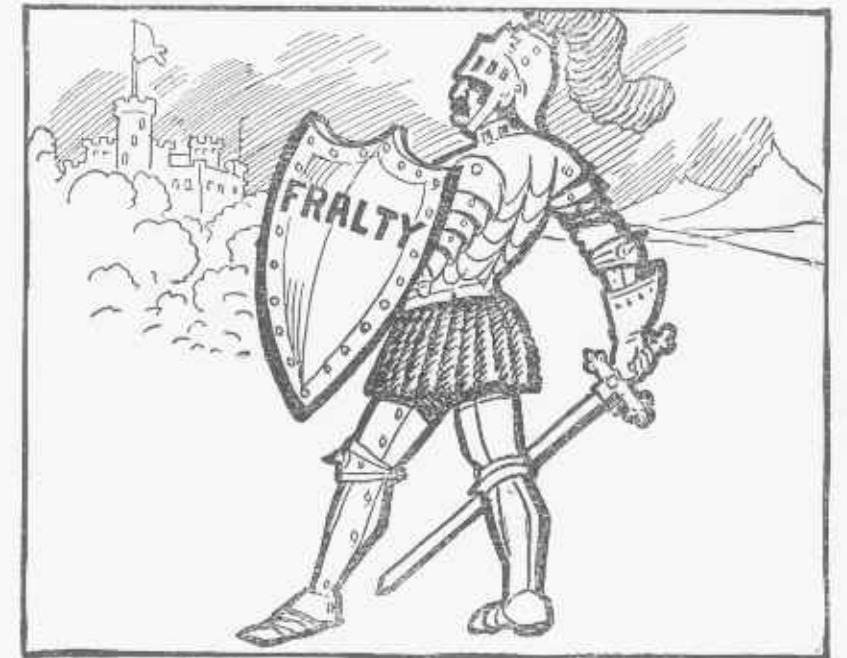

This noble knight has chosen a very peculiar motto. You will have to change one letter to know what word was intended.

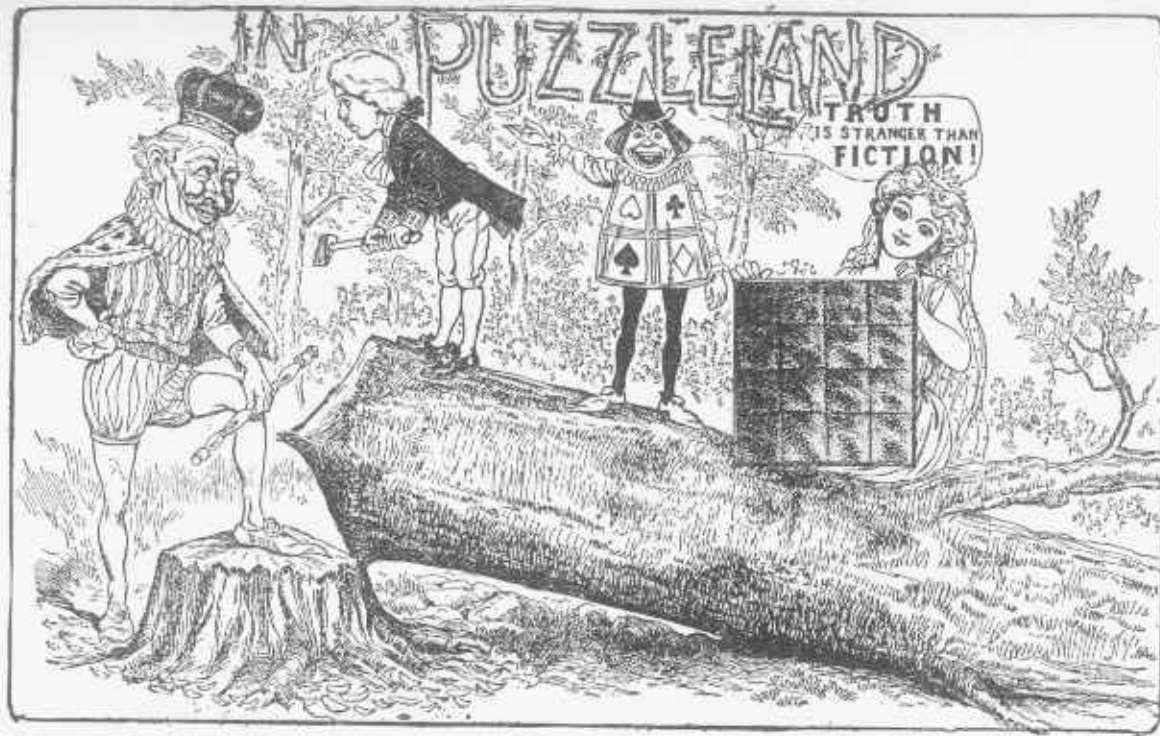

Little Tommy Riddles presents two remarkable puzzles for the consideration of students of American history. The youthful George Washington is shown to be taxing parental credulity by his awful confession of having cut down the cherry tree with that little hatchet, coupled with the claim of his inability to tell a lie, which in itself was very clever. For you see, if he had lied and said that he lied, he would have been telling the truth, whereas if he had not been lying, the fact of his saying that he had would not have made it so; hence his inability to tell a lie!

The puzzle to tax your cleverness, however, is to find concealed in the picture the portrait of Washington as he appeared when he became "The first in war, the first in peace and first in the hearts of his countrymen!"

In the second puzzle Princess Enigma is shown to be pondering over that famous geometrical problem of dividing a Washington Pie into six square pieces. Make them of different sizes if you wish, but let there be but six pieces, all perfectly square.

A Charade.

My first, an adjective of frequent use;
My second, is of no avail on land;
My whole, you may complain of, if you choose,
When cruelty uplifts her iron hand.

A Charade.

My first for trembling oft is nam'd,
My second in the battle fam'd;
Both these, my lovely fair ones join,
They paint a poet most divine.

A Charade.

My first is a noisome insect, my next a ferocious animal, and my whole is used to frighten children and fools.

Here is one of the old-time Illustrated Charade Puzzles of the time of our grand-daddies:



SAM LOYD'S CREDIT CHECK PUZZLE



Here is a clever little problem which illustrates the feminine instinct for shopping. Mrs. Bargain-hunter purchased \$1.30 worth of plates at the great china sale on Saturday, when 2 cents was marked off from every article. She returned them on Monday at regular prices,

exchanging them for cups and saucers, one plate being worth a cup and saucer, so she got 16 more articles; but as saucers were worth only 3 cents she took 10 more saucers than cups.

Can you tell how many cups she could have bought with her money on Saturday?



Once upon a time when Little Bo-Peep was tending her flocks upon the hills of Puzzleland, one of her many admirers presented her with a little lamb whose fleece was bright like gold.

Now Little Bo-Peep had two pet lambs which she enclosed in separate folds made of four bars each, as shown in the picture.

The puzzle is for you to find how to lay the eight bars (strips of paper may be used to illustrate the puzzle), four of which are twice as long as the others, so as to make three square folds of the same size.

A Charade.

What is that sound the silence breaks?
'Tis martial music, loud and clear.
An army comes: the firm ground shakes
With their measured tread, as my whole appear.
Their waving plumes, their helmets bright,
Proclaim my second's in my first,
My whole is, too, my first in fight,
As headlong on the foe they burst.

A Charade.

Ofttimes you'll find, laid up in store,
Within my first, my second,
In tales of love, and deeds of war,
Quite fair my whole is reckoned.

A Charade.

My first it term'd a vital juice,
The heath my second does produce,
The sturdiest oak that e'er was seen,
My tender total once has been.

MILITARY PUZZLE



The captain shouts an order to his squad. Can you change one letter and produce a word which reveals the order he wished to give?



Little Tommy Riddles announces that the admiral of the Swiss navy, who is a suitor for the hand of Princess Enigma, invites all clever people to discover how to cut the red part of the Swiss flag into the fewest possible number of pieces which can be fitted together so as to form a perfect square. This gives great scope for cleverness and ingenuity, for, while any one might perform the feat by making a dozen or more, a better answer requires fewer pieces.

Then the Swiss admiral gives the famous national puzzle which is used in all civil service examinations for the Swiss navy: Into how many pieces can you divide a Swiss cheese with five strokes of a sabre?

The admiral was also called upon to solve a pretty puzzle, which Tommy Riddles says puzzled Lasker, the chess champion of the world, although one does not have to be a chess or checker player to solve this problem. It is merely to guess how many pieces a checker board can be divided into without any two pieces being alike. The smallest piece might contain only one square, and the largest eight or a dozen, but no two pieces must be alike.

A Charade.

My first is the lightest of things, without doubt;
My second we should not be always without.
My whole, you will find, as a great prize is reckoned
By people who are a long way from my second.

A Charade.

My first is a person of whom we've all read,
On my second, I fear we oft heedlessly tread;
When these are selected, and rightly combin'd,
A substance proverbially hard you will find.

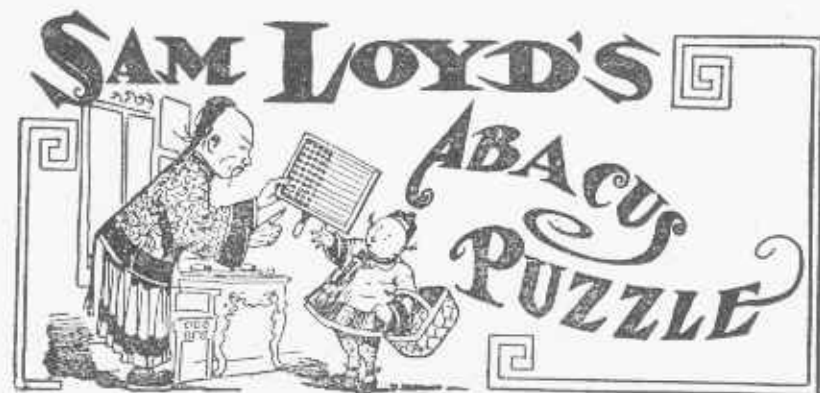

Here is a simple illustration of the calculations performed by the Chinese mathematicians with the abacus or "gridiron," as it is termed: A small merchant of Canton bought a number of fat puppies and rats, an equal number of each, paying two bits each for the puppy dogs and two

bits for a pair of rats. He sold them at an advance of 10 per cent. When he had disposed of all but seven he had just received the amount of his first outlay, so that his profit was represented by these seven animals. What are they worth at retail?

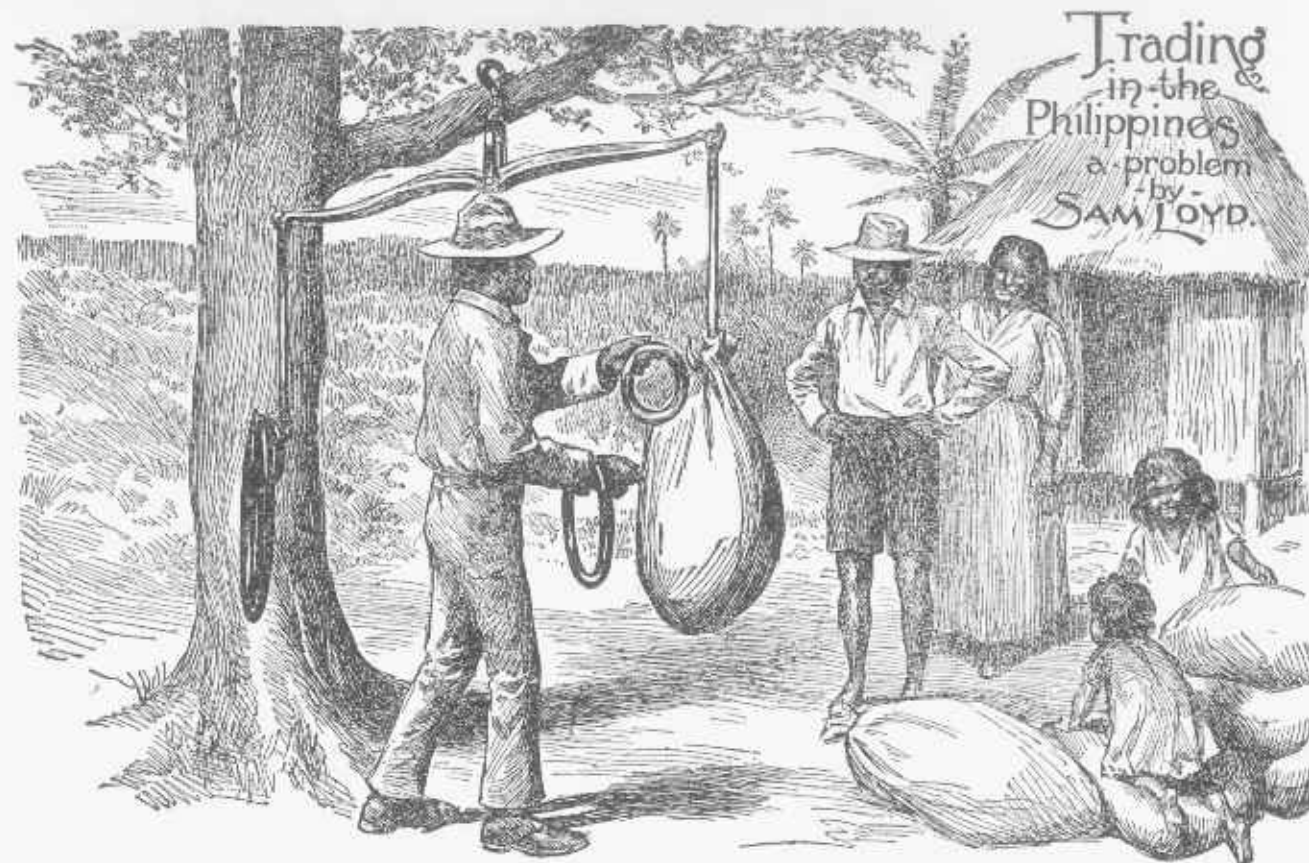

PROPOSITION—What are the weights of the four rings if they give any desired weight from a quarter of a pound up to ten.



RECENTLY CAME across an old book of travel which contains a picturesque description of the primitive methods of conducting business in our newly-acquired possessions in the far East. The staple products, which consist of rice, tobacco, hemp and sugar, grow abundantly all over the islands and are cultivated in little patches by the natives, who barter them for general merchandise with the itinerant traders.

I was particularly struck by the reference to the unique scales with which these traveling merchants weigh the products received in trade from the natives. The scales consist of a balance bar and four metal rings of different sizes, representing the weights, which the man wears or carries when journeying, in a somewhat picturesque manner, on his arms like bracelets.

With these four rings, which are used as weights and counter balances the trader can weigh anything from a quarter of a pound up to ten. A similar trick in juggling with weights is given in the puzzle books, but does not strike me as being so clever as this one, which really enables the

trader to get within a quarter of a pound of any weight. What are the weights of the separate rings?

In my journey around the world I once fell in with a jolly companion, who endeavored to impress upon me the importance of concealing one's nationality. He said that foreigners were always slighted or imposed

upon, so, as he remarked, even when he was presented at the court in Paris, he assumed some French title and received all the consideration given to the natives.

I could not see just how he concealed his identity so well, and as I now recall his general appearance, it suggests an excellent hidden city puzzle for the young folks.



They were announced as the 'Count Du Blinkenspel and lady!'

OUR COLUMBUS PROBLEM

FIND HOW TO ARRANGE THE FIGURES
 4 5 6 7 8 9 0
 IN AN ARITHMETICAL SUM WHICH
 ADDS UP THE NEAREST TO 82
SEE OUR GREAT PRIZE OFFER
 Send your answers on the following blank

NAME — DATE _____
 ADDRESS _____
 ANSWER _____

LOYD

Here is a famous prize problem I issued in 1882, offering \$1,000 as a prize for the best answer showing how to arrange the figures and dots .4.5.6.7.8.9.0. which would add up the nearest to 82. Out of several million answers, only two were found to be correct.

A Rebus

At first I'm advanced for interest or pelf;
 Behead, and you'll find I've a place on the shelf;
 But behead me again, and perform it with care,
 If you handle me now, you have need to beware.

Cipher Answer.—16, 12, 5, 4, 7, 5.

A Charade

The things which daily 'fore me pass,
 Cause me much deep reflection;
 Behead me, 'twould be hard to make
 A giddier selection.
 Behead again, sure stubbornness
 Will scarce escape detection.

Cipher Answer.—7, 12, 1, 19, 19.

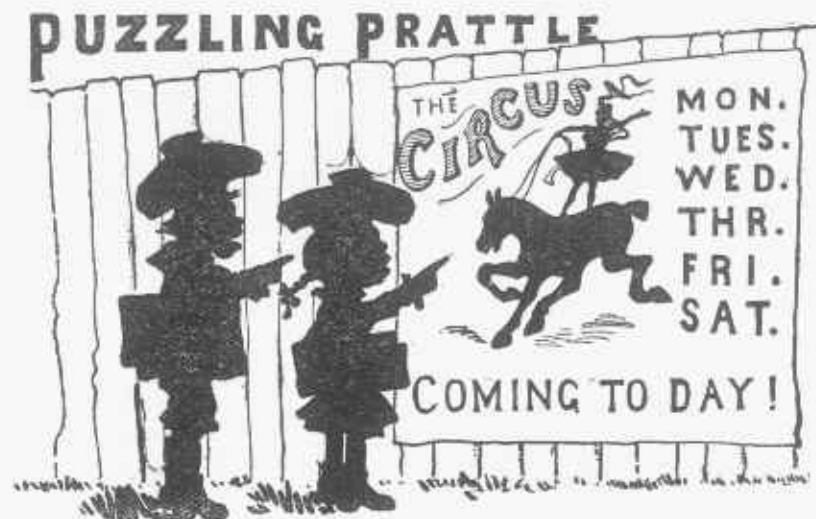

Two school children, who were all tangled up in their reckoning of the days of the week, paused to straighten matters out over a circus poster, when little Priscilla, who was hinting for an invitation to the show, remarked to John: "When the day

after to-morrow is yesterday, 'to-day' will be as far from Sunday as that day was which was 'to-day' when the day before yesterday was to-morrow!"
 On what day of the week did this puzzling prattle occur?

A Rebus

Take first a tree you often see,
 And then a letter add;
 It now will show where'er you go,
 What makes our homes so glad.
 If by mistake you now should take
 A letter, then how sad!
 You could not stay a single day
 'Twould make you simply mad!
 Cipher Answer.—6, 9, 18, 5.

A Charade

Crispin, snug in his cobbler's stall,
 Waxing his end and driving his all,
 A judge of my first may be reckoned;
 For deeds of blood my whole was famed,
 But innocence is often blamed;
 Transpose a grain for my second.

A Rebus.

My first two are beds ne'er slept upon;
 My next oft decks the regal crown;
 My whole may transient vantage gain,
 Yet leaves behind a moral stain.

Cipher Answer.—19, 20, 18, 1, 20, 1, 7, 5, 13.



Hidden Cities and Rivers.

Concealed geography wherein you are asked to find the name of the locality hidden in the description of the picture forms such an excellent introduction to the world of puzzlement, that I cannot refrain from presenting a large selection of similar subjects. It would be well if students would learn to form similar puzzles after guessing these:

1. It has been said that man sometimes *apes* the monkey.
2. The months of July and August are the warmest of the year.
3. Do you *still* imagine that labor controls capital?
4. The cable road ran ninety-three cars on the track yesterday.
5. It was a *miracle*—burnt almost to a crisp—she still lived!
6. Mary, you left the door open, and your *watch* is on the table.
7. *Stop!* or I may forget myself!
8. *Can I leave* my parcel here?
9. The pedestal was unique, and as for the *vase*, I never saw its equal.
10. She had on a beautiful silk dress.

Transpositions

First find a word you often say,
 It may be on a Sabbath day;
 Transpose it then, and it will tell
 What decorates your courser well.
 Again transpose, and you will see
 What every one bestows on me;
 Transpose again these letters four,
 And write them on the miser's door.

Cipher Answer.—1, 13, 5, 14.

Some Difficult Anagrams.

1. Mind, rat is on it.
2. A cute call.
3. 'Tis gin tea.
4. Oh, Ma, Pa ran.
5. Dan ties it on.
6. No car? Let me go!
7. Ma kept a lion.
8. Meat is on it.
9. No tool is right.
10. Let man love.

Make one word with each line.

Answers to the above will be found in the following words:
 Malevolence, Conglomerate, Kleptomaniac, Estimation, Ornithologist, Administration, Calculate, Instigate, Panorama, Destination.

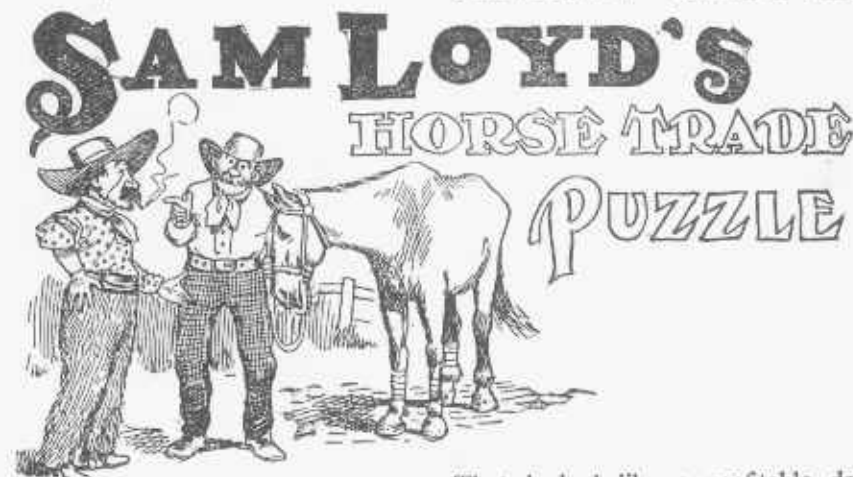

For some reason or other I never was much of a success as a horse trader. I bought a broncho down in Texas for \$26, and after paying for his keep for a while sold him for \$60.

A Rebus.

When chappies tell their love to maiden's fair,
 My chilling first fills their hearts with despair;
 Ah! fly from my second, dear youth, 'tis your bane,
 Its fruits are repentance, and sorrow and pain;
 Woo the arts and fair science, and press to the goal,
 You may gain it, though now you are merely my whole.
 Cipher Answer.—14, 15, 22, 9, 3, 5.

A Rebus.

My first, dear ladies, has no end,
 And it may quickly visit you,
 Whispering softly, "I attend
 To bind a knot that's endless, too."
 My next is only half a letter,
 Nor need you long that letter seek;
 My whole adds charm to every feature,
 And graceful decks the beauty's cheek.
 Cipher Answer.—18, 9, 14, 7, 12, 5, 20.

Would you know of what to make a coat if you couldn't get fine clothes? Of course (coarse).

How did Peter spell his name? With ease (e's).

Does a man know what he proposes to be when he chooses the trade of a blacksmith? To be shoer (sure).

That looked like a profitable deal. Nevertheless, I found that I had lost just half of the original price and one-quarter of the cost of keep.

Can you figure out just how much I lost on the deal?

THE BATTLE OF THE FOUR OAKS

PROBLEM BY SAM LOYD

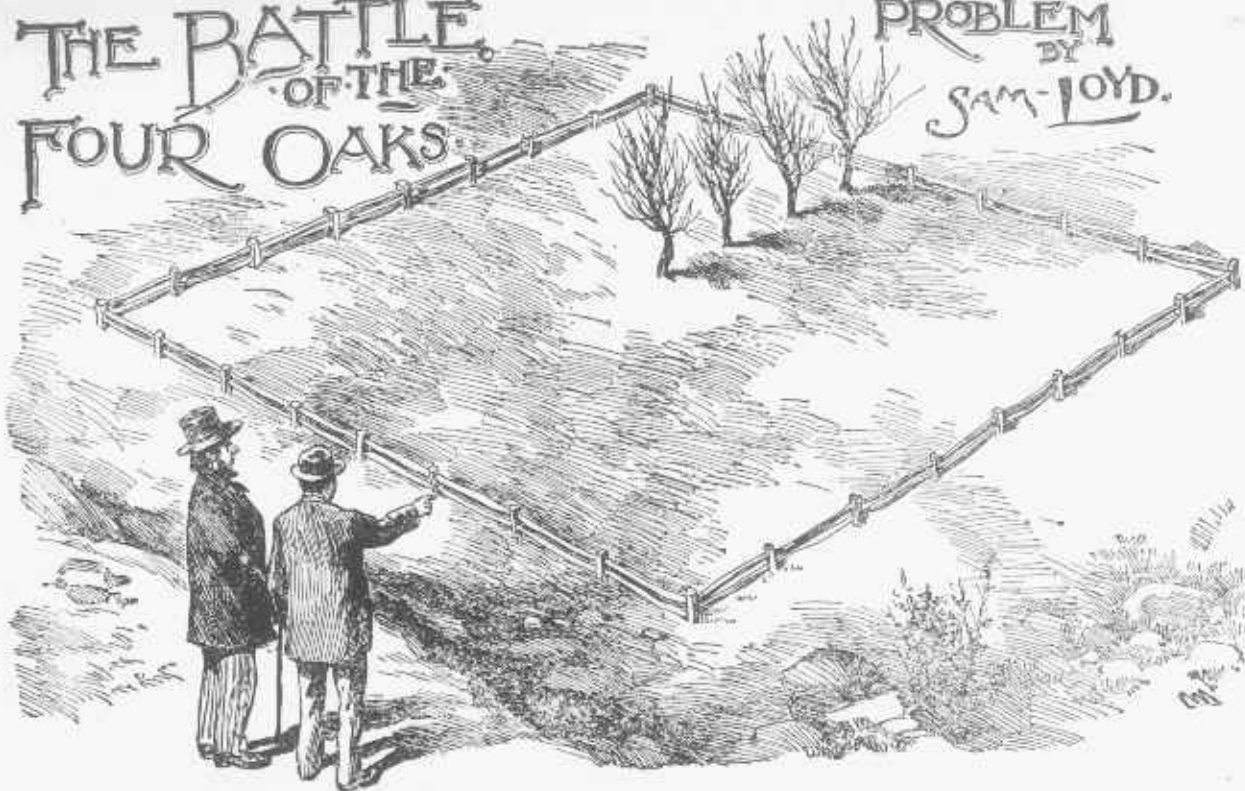

PROPOSITION—Divide the field into four parts.

HERE IS AN ODD little puzzle based upon the possibility of dividing a square field, upon which there is a row of four trees, into four pieces of the same size and shape, and to be so arranged that each of the pieces will contain one of the trees. The puzzle is based upon an incident which is said to have occurred in the Far West, at a place called Four Oaks, which derived its name from the main facts of the story as told to me, although it had to be considerably modified to be presentable in puzzle form. I have had to reduce the field of operation, as shown in the sketch, to what might pass for a five or ten-acre plot, and to place the trees in a row, whereas, according to the popular version of the story, the piece of ground covered some seven thousand acres, and the four oaks, which served as important landmarks, were nearly a mile apart. I was told that Four Oaks derived its name from the fact that one of the early settlers, who owned a large tract of land, having devised it to his four sons, with the stipulation that they should "divide it into equal portions, as indicated by the positions of four ancient oaks, which had always served as landmarks."

The sons were unable to divide the land amicably, as the four trees really furnished no clue to guide them, so they went to law over it and squandered the entire estate in what was known as the "battle of the four oaks." The person who told me of it suggested that it might form the groundwork for a good puzzle, which it has done, so far as the suggesting of a theme is concerned, but it is needless to say that the problem and sketch is given to show how puzzle ideas may be gleaned from any incidents as we journey by the way with our eyes and ears open.

The picture represents a square field with four ancient oak trees, equal distance apart, in a row from the center to one side of the field. The property was left to four sons, who were instructed to divide the field into four pieces, each of the same shape and size, and so that each piece of land would contain one of the trees. As the puzzle is an impromptu one, gotten up on the spur of the moment, somewhat in the nature of a challenge to fill the bill as told, it is really not very difficult, nevertheless it is safe to say that everyone will not hit upon the best possible answer.

What is best out? A conflagration.

A REBUS.

An animal tired of his kind,
Being just inclined to go astray;
One slightly changed came up behind
And surely then it flew away.

CHARADE.

My first for ages dangerous reckoned,
Was ne'er so deadly as my second;
If rightly you conjoin the two,
I tell what every man should do.

Why is a sporting clergyman like a soldier who runs from a fight? Because he departs from his sphere of action (fear of action).

When does a man impose on himself? When he taxes his memory.

Why are chemists and alchemists both of the feminine gender? Because one is an analyser (Ann Eliza), the other a charlatan (Charlotte Ann).

What are the requisites for a lady who desires to enter the cigar trade? She ought to have capital to back her, be up to snuff, always looking for a quid pro quo, and then she will succeed if she chews.

Who was Jonah's tutor? The whale that brought him up.

What is the only pain of which every one makes light? A window pane.

SWITCH BOARD

PROBLEM BY SAM LOYD

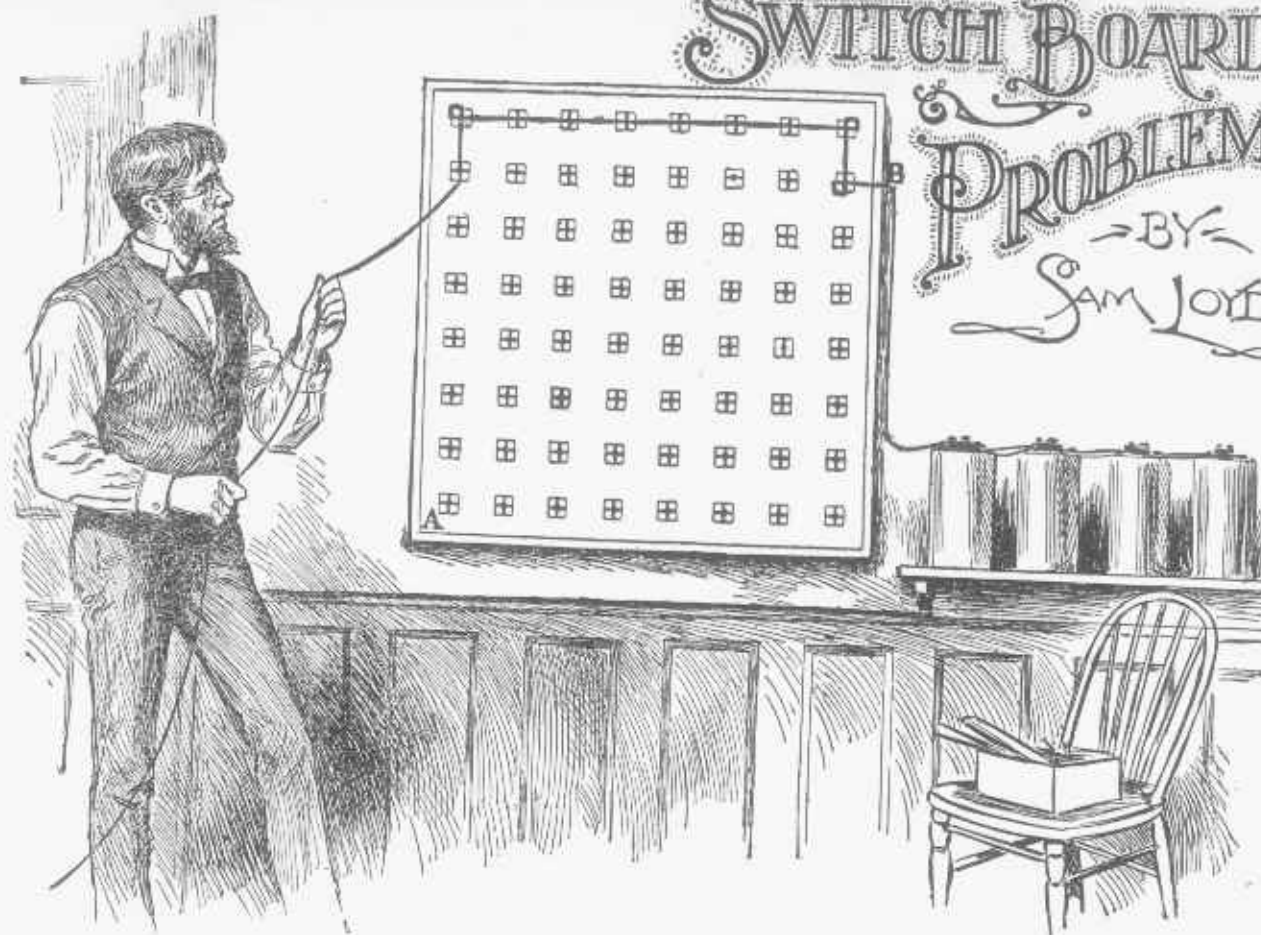

PROPOSITION—Show how much wire it will take for the switchboard.



SHOWING HOW good puzzle ideas as well as information may be picked up from time to time "as we journey by the way," I will give a little problem that I was called upon to tackle the other day, which scores a point for the puzzlist. I found two electricians who had invented some kind of switchboard or annunciator, wrangling over the most economical method of stringing a fine copper wire, which should connect all of the contact points together. It was an elaborate affair, consisting of some hundred points, but as sixty-four is sufficient to illustrate our problem, only an 8x8 section of the board is given.

The problem is to find the shortest length of wire, going from B to A passing across the centers of the sixty-four squares. The squares are supposed to be one inch wide and exactly two inches apart. These dimensions will show that an inch of wire is required in making the necessary winds around the corners

in the angles of the proposed route of the wire.

You may draw a similar 8x8 design of 64 squares, observing that two of them can only be crossed in one way, and mark out the answer, showing the line along which you would string the wire, or merely state the least possible number of inches of wire required to perform the feat.

A CHARADE.

My first will range the meadow through,

In savage pride and state;
But should he make my next at you,
Your danger would be great.

My whole in russet cap is found,
And robe of lovely green,
Tall, springing from the marshy ground,

Like some bright Fairy Queen.
Ans. 2, 21, 12, 12, 18, 21, 19, 8.

What is the difference between photography and measles? One makes fac similes, the other sick families.

A REBUS.

I'm of little importance, so off with my head,
To a foe I might then be the terror and dread;
Decapitate twice, and reverse what remains,
And lo! you're a wandering sprite for your pains.
Cypher Ans. 20, 18, 9, 6, 12, 5.

A CHARADE.

Aristides had, of Grecian fame
My first appended to his name!
Where Boreas reigns my next is found,

Immersed in Ocean's depths profound!
My whole the balance rightly scans,
And baffles Fraud's unhallowed plans!
Cypher Ans. 10, 21, 19, 20, 9, 3, 5.

Why are ladies who wear large crinolines ugly? Because they are not even passable.

Why should a man never marry a woman named Ellen? Because he rings his own (K)nell.



Here is a clever little study in concealed geography wherein you are asked to find the locality of the scene hidden in the description of the picture. Puzzles of this kind are always amusing and instructive, as they familiarize students with their geography, so we give a further instalment of clever hidden subjects:

- 195. *We seriously mean to go.* (River.)
- 196. *A rebel belonging to the Tenth was shot.* (River.)
- 197. *When with a mesmerizer shut your eyes.* (River.)
- 198. *She began gesticulating, and I laughed.* (River.)
- 199. *She lost her hat! a gushing thing!* (River.)
- 200. *How can a damson pie be converted into a squash pie?* (Province.)
- 201. *Give me a kiss in genteel style.*
- 202. *It is astonishing. Ham and eggs is his favorite diet.*
- 203. *Have you a turban? Go, rascal, if you have.*
- 204. *In the days of Nero, they covered the foot with a sandal to narrow it.*
- 205. *Simpson, son and sire, landed on the twenty-fifth.* (Country.)
- 206. *He that is last at the club will be the last at breakfast.*
- 207. *Far yet near, absent though present.*
- 208. *Did the old man lean on a staff, or did he walk with a crutch?*

- 209. *Aunt Jerushy rides a cream-colored horse.*
- 210. *Susan loved a maniac; her only brother objected.*
- 211. *Round the rude crag raves endlessly the sea.*
- 212. *Said Brown Brothers and Co., Roman, delve on.*
- 213. *Travelers asperse Polish innkeepers as extortionate.*
- 214. *From the record oval mirrors were omitted.*

SAM LOYD'S EGG PUZZLE



"Hans," said the corner grocer to his new boy, "now you saw me lay those eggs carefully in a pile, so do not let me hear you tell another customer that you do not know if those

eggs had just been laid. Run over to Prof. Klugler and ask how high it is safe to build a pyramid of eggs, if each egg weighs two ounces and would sustain a pressure of eight pounds?"

A Charade

Without my first, I'd have you know,
My beard a frightful length would grow;
Discordant noises from my next
Might make you feel annoyed and vexed:
My whole's the best—you need not doubt it,
For he's a rogue who is without it.
Cipher Answer.—8, 15, 14, 5, 19,
20, 25.

A Rebus

Should you suspend my first, no art
Can to my next its charm impart,
Or make it sweetly sound;
And should a rope my whole embrace,
You'll find from it in sad disgrace,
No credit can rebound.
Cipher Answer.—23, 9, 14, 4, 16,
9, 16, 5.

A Rebus

Behold a young and tender family,
And then a small estate you'll plainly see;
Reverse, and a protection safe is found,
When the midnight darkness envelops round.
Cipher Answer.—2, 18, 15, 15, 4

PUZZLE OF THE Red Spade

BY
SAM LOYD

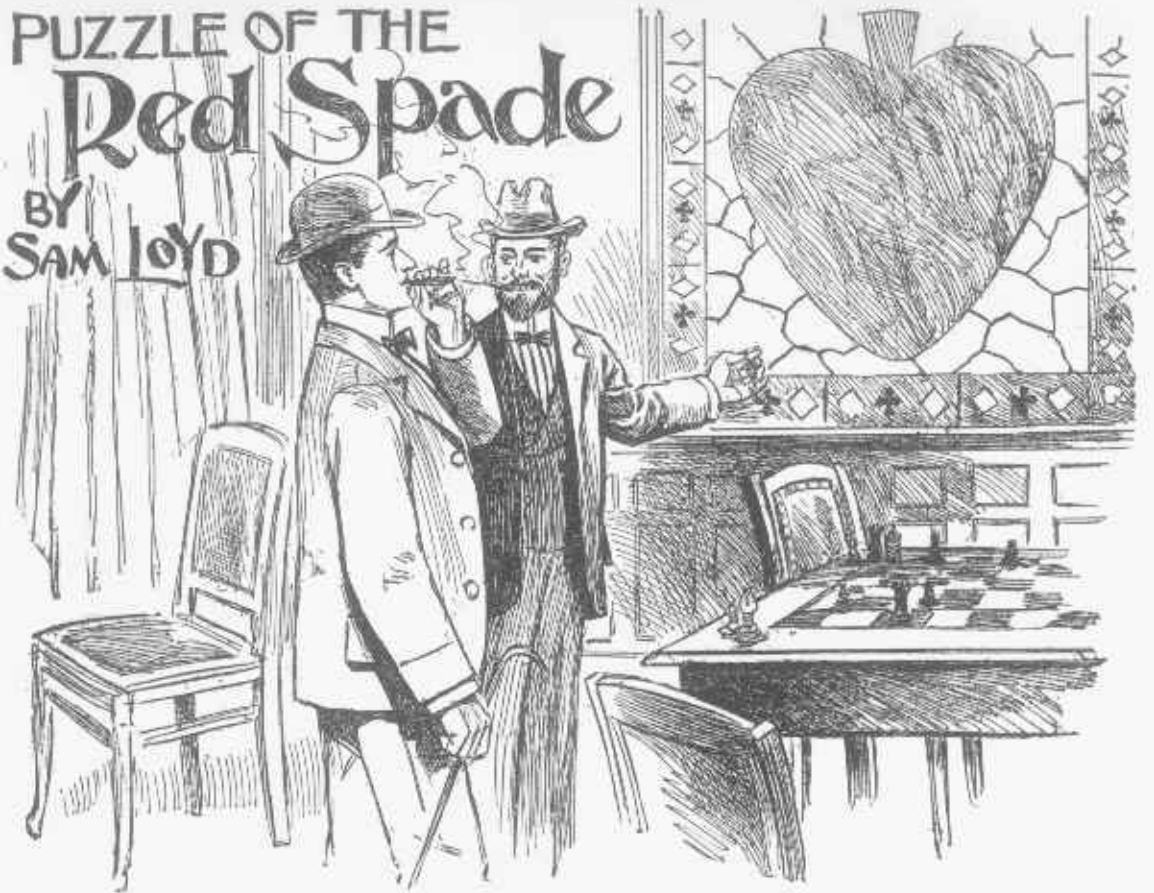

PROPOSITION—Show how to change a spade into a heart.

DURING A RECENT visit to the Crescent City Whist and Chess Club my attention was called to the curious feature of a red spade which appears in one of the windows of the main reception room. The design came from Dresden, and, after the manner of cathedral windows, is made of numerous small pieces of stained glass skillfully fitted together, so as to make the desired pattern.

No reason was ever vouchsafed, nor even asked for, regarding the incongruousness of the color of the emblem. It was looked upon as a blunder which occasioned considerable comment at first, but which came to be looked upon afterwards with favor, not only on account of the novelty of such a thing as a red spade, but from the recognized point that a black spade would make the room too dark.

Hearing, accidentally, however, that a blunder had actually been committed by the manufacturer, in that the ace of hearts was to have been the insignia of the club, I was led to examine the window carefully and found that the spade was com-

posed of three pieces, and speedily discovered that by proper arrangement of the three pieces they would fit together so as to form the ace of hearts, as originally desired.

The members have become so accustomed, not to say endeared, to their unique emblem that they would not consent to having the same changed, nevertheless it makes a unique although simple puzzle, and the honor will be divided among such of our young friends as discover the best way of dividing the spade, as shown, into three pieces, which can be arranged so as to form a perfect ace of hearts.

My first for trembling oft is named,
My second in the battle famed;
Both these, when joined to make
my whole
Will name a poet full of soul.
Shakespear.

My first is the sound made by my
second, but my whole does not exist?
Hum-bug.

My first is an insect, and my
whole is used to frighten children
and foolish people? Bug-bear.

A REBUS.

I am borne on the gale in the stillness of night,
A sentinel's signal that all is not right.
I am a swallow, yet skim o'er the wave;
I am a doctor, yet patients I save;
When the sapling has grown to a flourishing tree,
It finds a protector henceforward in me?
Bark!

CHARADE.

Eliza was looking untidy to-day
As she may very often be seen;
For my whole round her head,
though they useful may be,
Are not ornamental, I ween.
Let her twist up my first in her
second at night,
She should take them all out in
the morn,
For my whole, though they be
pretty well in their way,
Ought never at noon to be worn.
Curl-papers.

Why is an orange like a church
steeple? Because we have a peel
from it.

PLAYING THE SYSTEMS

BY SAM LOYD



PROPOSITION—Show how to win 777,777 francs by betting only the multiple of seven.

THE RECENT STATEMENT that some one had won 777,777 francs at Monte Carlo recalls the principle of Lord Rosslyn's system, promulgated a few years ago.

Without going into the technicalities of the play of roulette as practiced at Monte Carlo we will accept the statement that Lord Rosslyn's system was based upon the principle of playing the multiples of seven and ask our puzzlists to tackle the following simple problem.

Supposing a player (merely betting on red or black, where the chances are even), lays down a single franc piece seven times in succession and then whether he won or lost raises the stakes to 7 francs and again plays seven times. He then bets 49 francs seven times; then 343 francs seven times; then 2,401 francs seven times; then 16,807 francs seven times; then 117,649 francs seven times. If by thus playing 49 times he chanced to win 777,777 francs, how many times did he win to gain that amount?

This is somewhat simple, nevertheless interesting at the present

time as illustrating the utter absurdity of what became known for some time as "Rosslyn's lucky system." If you cannot produce the exact sum of 777,777 francs at first, a few experimental trials will show that the puzzle is not so mathematical as it looks.

A CHARADE.

My first is a bird, my second a fish,
And each has served upon a warm dish;
My whole an insect which feeds like ourselves
On anything good it finds on the shelves.
Cypher Ans. 3, 15, 3, 11, 18, 15, 1, 3, 8.

A REBUS.

Short was my life, and brilliant my career;
Behold me, I in lovely green appear;
Behold again, I once was made to save
My chosen inmates from a watery grave.
Cypher Ans. 19, 16, 1, 18, 11.

Why is Canada like courtship?
Because it borders on the United States.

A REBUS.

A piece of kitchen furniture,
I'm useful in my place;
The servants always like to see
My comfortable face.

Transpose me, quickly drive me hence,

Alas, my pretty creatures!
Where I remain is little sense
And sadly altered features.
Cypher Ans. 18, 1, 14, 7, 5.

A CHARADE.

My modest first would ne'er aspire
To rise above an equal,
To pity of my next has claim,
A safeguard is the sequel.

What is it that which every living being has seen, but will never see again? Yesterday.

Who is the oldest lunatic on record? Time out of mind.

Why does a young lady prefer her mother's fortune to her father's? Because, though she likes patrimony she still likes better—matrimony.

What is the best way to enjoy happiness of courtship? To get a little gal-an'-try.

What must be done to conduct a newspaper right? Write.

IN ANCIENT GREECE

BY SAM LOYD



PROPOSITION—Draw the Greek symbol with a continuous line, making the fewest possible turns.



IN LOOKING OVER some photographs of marvelous relics of ancient times unearthed during the recent excavations in Greece, I was struck by the repeated appearance of the symbol of the circle and the triangle. Not entering into the discussion regarding the accepted interpretation of the sign about which many volumes have been written by men of learning, I will merely call attention to the curious mathematical or puzzle feature which always appears to be a part of the scheme in such matters.

The sign is attached to certain inscriptions on memorial monuments somewhat in the nature of a seal or signature, and is suggestive of the well-known puzzle of Mahomet, which, like many similar tricks of ancient origin, was to be drawn by one continuous line. It is a pleasing and interesting feat to discover the method of doing the trick by one continuous line, without going over any line twice, but if we change the turns to the more popular plan of going over the same lines as often as one wishes, and merely require

that the figure must be drawn by one continuous line, making the fewest possible number of turns, it becomes by long odds the best puzzle of its kind ever produced, so it is given to our puzzlists in that form.

My first is a useful animal, my

second a root, and my whole is a root. Horse-radish.

Students in concealed geography are invited to discover the locality of the little incident which I sketched during a trip through foreign parts.

Yacob lent Zena a hand to bring home the fagots



THE BOY'S AGE

—PUZZLE—
BY
SAM LOYD

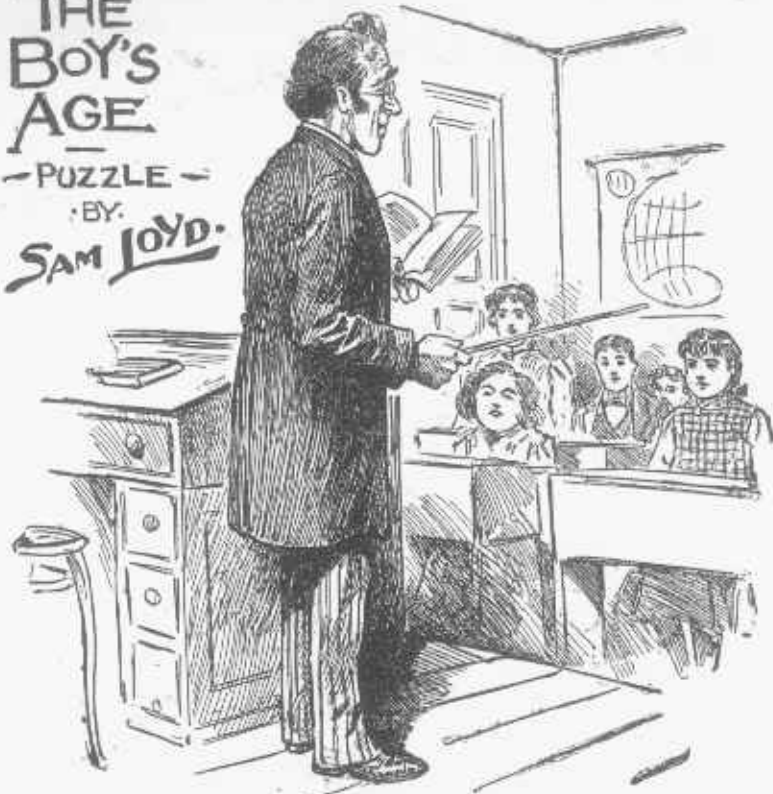

PROPOSITION—Guess the boy's age.

HERE IS A REMARKABLE age problem, which I am sure will amuse the young folks and at the same time open up a new line of reasoning for some of the wisecracks who make a specialty of statistical calculations.

It appears that an ingenious or eccentric teacher, as the case may be, being desirous of bringing together a number of older pupils into a class he was forming, offered to give a prize each day to the side of boys or girls whose combined ages would prove to be the greatest.

Well, on the first day there was only one boy and one girl in attendance, and, as the boy's age was just twice that of the girl's, the first day's prize went to the boy.

The next day the girl brought her sister to school, and it was found that their combined ages were just twice that of the boy, so the two girls divided the prize.

When school opened the next day, however, the boy had recruited one of his brothers, and it was found that the combined ages of the two boys were exactly twice as much as the ages of the two girls, so the boys carried off the honors of that day and divided the prizes between them.

The battle waxed warm now between the Jones and Brown families,

CRIMINAL CLASSES

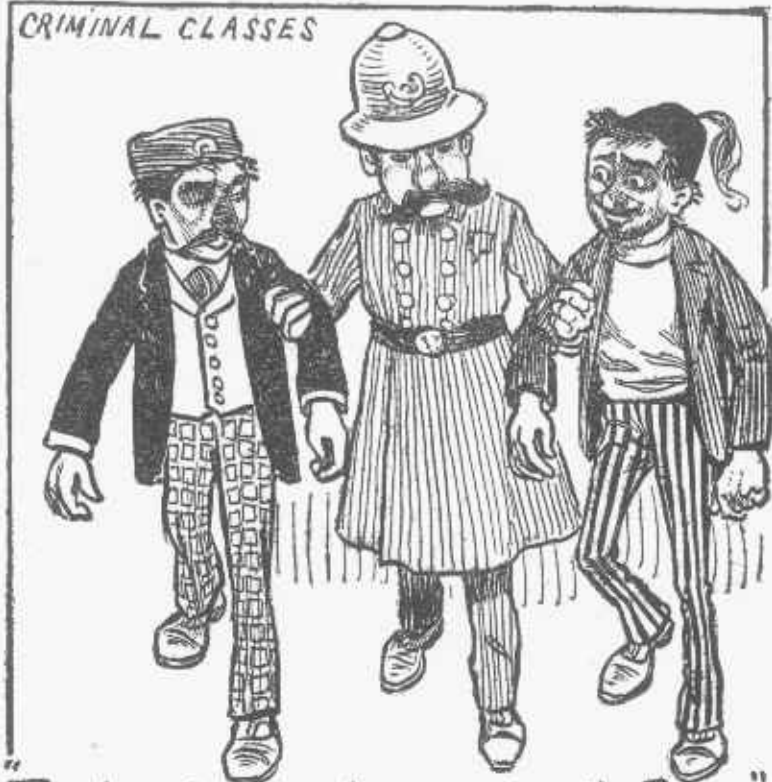

"Two burglar men I arrested on the Bowery"

and on the fourth day the two girls appeared accompanied by their elder sister; so it was then the combined ages of the three girls against the two boys, and the girls won of course, once more bringing their ages up to just twice that of the boys. Again the struggle went on until the class was filled up, but as our problem does not need to go further than this point, to tell me the age of that first boy, provided that the last young lady joined the class on her twenty-first birthday.

It is a simple but pretty puzzle, which calls for ingenuity rather than mathematics, and yields readily to puzzle methods.

What is that which will give a cold, cure a cold, and pay the doctor's bill? A draught (draft).

What is that which no one wishes to have, yet no one cares to lose? Bald head.

CRIMINAL CLASSES

As a study in concealed geography we ask our young friends to give the nationality of two hapless foreigners who got mixed up in a scrimmage on the Bowery and got pulled in as burglars, while the real culprits who had a political pull escaped with their booty.

A MAZE PUZZLE

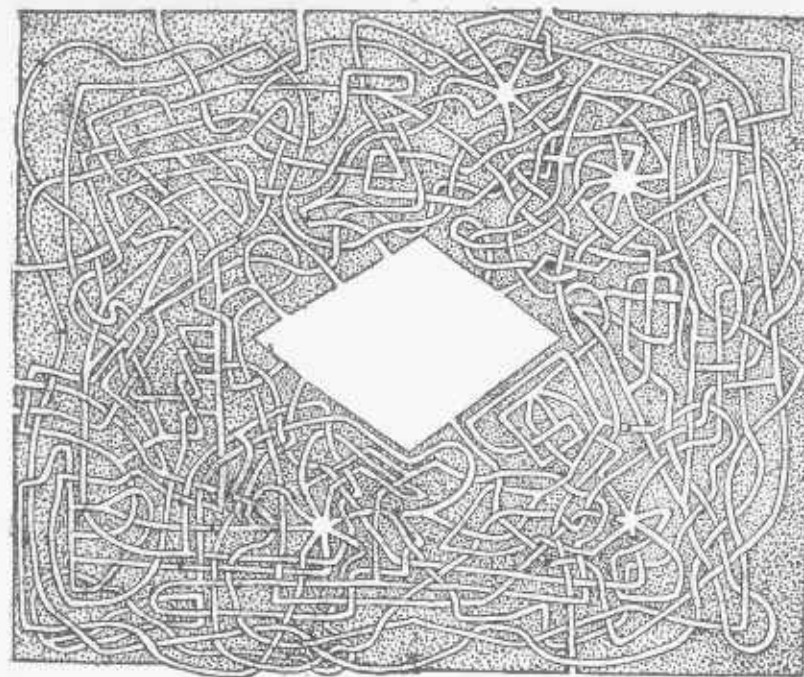

Any or every style of puzzle which excites interest or affords amusement is beneficial, in that it trains the mind to concentrate and pursue a line of thought to a definite purpose. Maze puzzles are always interesting to both young and old on account of the historical associations which connects them with noted mazes in ancient parks and gardens, as well as from the innate pleasure we all feel in overcoming seeming obstacles. Of course there are many styles of labyrinths with various conditions which make them more or less difficult, but the above may be said to be one of the best because the crossing of paths by means of bridges permits of a much wider range of travel than the old fashioned limitation to branch walks. This puzzle is by Lewis Carroll, who as you all remember, wrote Alice in Wonderland, was a great mathematician and a noted puzzlist. It is supposed to represent poor little Alice lost in the woods; she starts from the little park in the centre and wishes to get out of the woods to go home. Can you give her any assistance in finding the correct path? You will notice that some of the paths are obstructed so as to make you retrace your steps, but not to be discouraged just remember that Euber formulated a rule for solving all mazes. Nevertheless it is quite a clever and difficult puzzle.

A Rebus

My first is a negative greatly in use, Which people first say when they mean to refuse;

My second we'll call a measure of weight, Frequently used when talking of freight.

An article always in use in my whole, With texture and form under fashion's control;

A something that's needed all over the earth, Yet often is quoted a thing of small worth.

Cipher Answer.—2, 21, 20, 20, 15, 14.

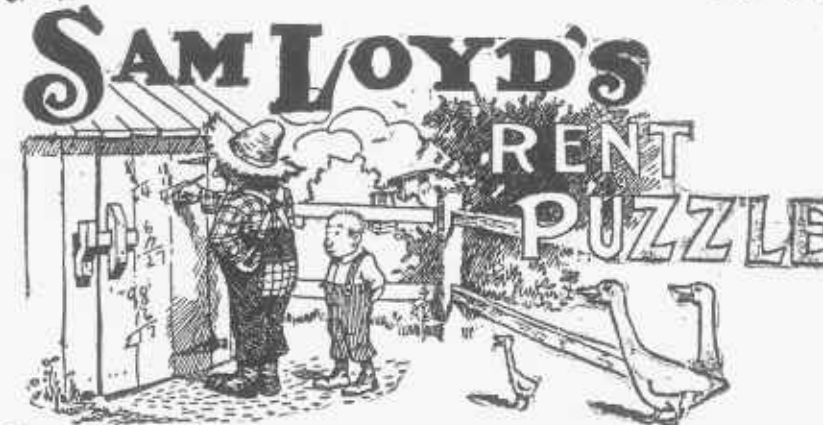

Farmer Sykes was complaining to Ikey that he agreed to pay \$80 cash and a fixed number of bushels of wheat as the yearly rental for his farm. That, he explained, would amount to just \$7 an acre when

A Charade

Here is one of the oldest style of charades, now quite out of date:

An animal, harmless and meek, The monarch and pride of the wood;

What issues whenever we speak, What is shunned by the wise and the good;

The initials enjoin, and you then will have plain

What often gives pleasure but sometimes gives pain.

Cipher Answer.—12, 1, 13, 2; 15, 1, 11; 22, 15, 9, 3, 5; 5, 22, 9, 12.

A Rebus

My first is a pet the housewives detest,

Its ravages always deplored; The harp and the green in my second are seen,

Though often my third is ignored. With a harp in hand my whole may now stand,

Like a treasure, safe from first stored.

Cipher Answer.—13, 15, 20, 8; 5, 18, 9, 14; 12, 1, 23.

A Riddle

Take of a wild beast two fifths, if you will,

Head and tail of a mouse, we will say;

'Twill name what thousands are striving to kill,

Though they're killed by the same every day.

Cipher Answer.—20, 9, 13, 5.

SAM LOYD'S RENT PUZZLE

wheat was worth 75 cents a bushel, but as wheat was now worth \$1 a bushel he was paying \$8 per acre, which he thought was too much.

Can you tell how large the farm was?



Trade Secrets

BY SAM LOYD.

PROPOSITION—Read the sign chalked on his coat.

THINGS ARE OUT OF joint," remarked a communicative gent who shared a park bench with me the other day. "Those trusts and competition are cutting the heart out of business, and it's just dog eat dog, or every one for himself."

"I used to belong to the Advertiser's Mutual Help Association, but the organization affiliated with the Benevolence Solicitors, the Insurance Canvassers, the United Colporturs, and eventually the organ grinders and mendicants, which put an end to our Halcyon days. There were complaints that the union printers would buy back blocks of returns from colporturs and poster men who were not in good standing with the association. The professional walking gentlemen also insinuated that the trade journal fakirs and fellows with schemes worked both sides of the street, and they retaliated by putting the secret 'good thing' sign on the sidewalks or doors of places when the 'oysters' were out of town, or where there was no show for 'biz' at all, which made hundreds of us waste time and even

sometimes get roughly handled." "Then some of the practical jokers marked the 'good thing' sign in front of deaf and dumb asylums to annoy the musicians, or steered sympathy men and veterans up against distributors of work or meal tickets, when there was no chance for beer money, so the entire 'profess' was soon at loggerheads." Many stenographers belong to the organization, so the meaning of the "good thing" sign as shown on the door post in the picture will be familiar to such as are posted, but being desirous of seeing just how many of the veterans recall, or may be able to decipher the meaning of the personal sign which used to be tagged or chalked on to recognized philanthropists, as shown in the picture, it is presented in the nature of a capital repus buzzle.

Why are talkative young men like young pigs? Because they are likeli to become bores.
 Why are tight shoes like summer showers? They make the corn grow.
 When is a candle like a new tombstone? When it is set up for a late husband.

What is the difference between attempted homicide and pig killing? One is assault with attempt to kill, and the other killing with intent to salt.
 Why is a reckless fellow like a man stabbing at a shadow? Because he strikes at nothing.
 What ship do the ladies prefer to embark in? Court-ship.
 What kind of a lock should be placed on your forest preserves? Hem-lock.
 What lock requires the attention of a physician? Lock-jaw.
 What is the difference between a schoolmaster and a railroad conductor? One trains the mind and the other minds the train.
 What kind of essence does a young man prefer when he pops the question? Acquiescence.
 What is the difference between an auction and sea sickness? One is the sale of effects, and the other the effects of a sale.
 Why is chicken-pie like a gunsmith's shop? Because it contains fowl-in-pieces.
 Which is the strongest day of the seven? Sunday, because the others are week days.

THE MONASTERY TREASURE

BY SAM LOYD.

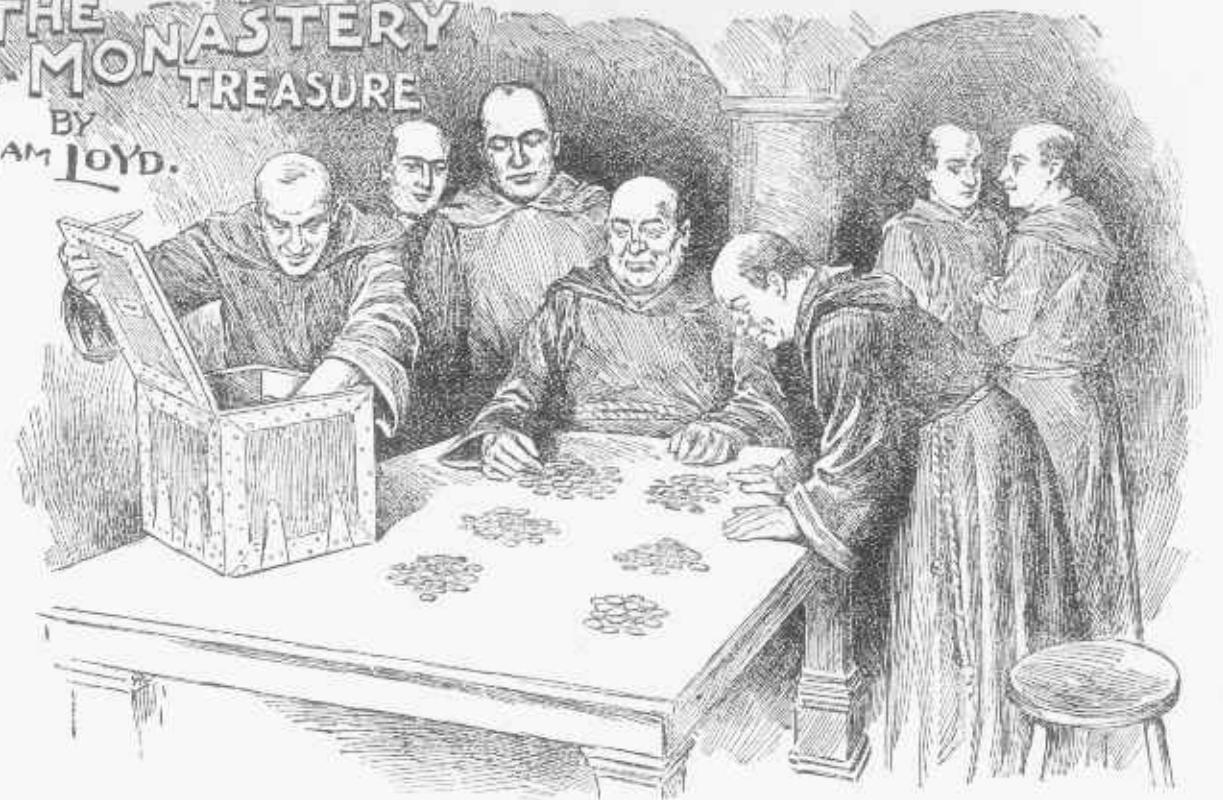

PROPOSITION—How many coins had the monks.



THERE IS A BIT OF Italian legendry from the Fifth Century, which involves a pretty although simple problem, which will greatly interest our puzzlists. It appears that according to the rules of one of the monasteries of the St. Benedictine order founded in the Fifth Century, the black friars, as the monks of that order were called, were required to see that a weekly contribution of one coin, supposed to represent one-tenth of the money collected during the week should be dropped into the treasury chest of the monastery.

The value of the coin has nothing to do with the problem, although from its being called "tithe money," which in those days meant "one-tenth," the coins thus collected showed the annual receipts of the treasury represented in weeks and years.

The coin was dropped into the chest every Saturday, and according to the rules of the monastery, the whole amount was only counted at such times as when Saturday occurred on the last day of the year. The treasure was formally counted three times, and a record of the same made and with the chest given into the custodianship of new guardians

appointed at each meeting, although according to the word of an eminent authority on such matters, no object was ever assigned for the collection of the money, aside from the feature of keeping a record of the monastery.

If I might be permitted to make a slight digression, it may be asked how it is that, in view of there having been fourteen popes of the name of Benedict, and of the fact of St. Benedict having enforced the vow of celibacy upon his followers, by what right or reason Shakespeare leads us to style all married men as Benedicts?

But to get back to the simple little problem which our puzzlists can answer, let us assume that this particular Benedictine monastery was founded on the first day of a year beginning on a Sunday, and that one coin was dropped into the treasure chest every Saturday, until such time as the year would end on a Saturday, and that the coins might be counted by dividing them evenly into four piles, or five piles, or six piles—each pile exactly alike—how many coins would there be?

Which of the four seasons is the most literary? Autumn, for then the leaves are turned, and they are red (read).

A REBUS.

Take the head of a fish, and the heart of an ace,
 With one fourth of whatever is mean and base;
 To those add a title of highest degree
 And the meanest and basest of mortals you'll see.

CHARADE.

Allow my first and third to meet
 They form a noble ranger,
 My second panders to deceit,
 And in my whole there's danger.

How do we know that Lord Byron was good-tempered? Because he always kept his collar (choler) down.
 What is the difference between a person late for the train and a schoolmistress? One misses the train, the other trains the misses.

Why are doctors always bad characters? Because the worse people are the more they are with them.

Why is the world like music? Because it is full of sharps and flats.
 Why should a man troubled with the gout make his will? Because he will then have his legatees (leg at ease).

Why is a coach going down a steep hill like St. George? Because it's always drawn with the drag-on.



Once while staying in London I noticed that after a heavy wind storm, which lasted for over a week, the fog had been blown away to such an extent that we would see the tops of the church steeples. I called the attention of several Englishmen to the fact, and was told that the same thing had occurred in 1776, when it was ascertained that all of the steeples were provided with weather cocks, in order to inculcate a well-known moral lesson, and not, as one might suppose, to tell the direction of the wind.

The maxim or moral point of the lesson, however, was so well known that like all common things, it had become forgotten. I could find no one who knew it, although every one remembered the fact, and the custom of putting weather cocks upon all steeples was still maintained for that purpose.

I present a sketch taken from my hotel window and will ask my puzzle friends to help solve the conundrum as to what moral lesson is inculcated by the weather cock on a church steeple?



While going from Inverness to Glasgow, a distance of 189 miles, where the tourist has the choice of looping the loops on a veritable scenic railway, or of bumping the bumps and shooting the chutes on a lumbering old stage coach, I selected the latter as being just half a day quicker. From that circumstance I was enabled to jot down one of the most interesting puzzles of my globe trotting tour. The train as well as the diligence left simultaneously from opposite ends of the route, so, by the aid of the milestones I was

able to figure out that when we met the train from Glasgow we had beaten it just as many miles as we had been traveling hours. From this and the other facts mentioned, I ask you to tell just how far we were from Glasgow when we met?

I seen from an entry in my notebook that I asked a Scottish gentleman who was touring with his family why the Scottish gentry always traveled third-class. He replied that it was because there was no fourth class. I can not see, however, that this item had anything to do with the problem.

A Rebus

To meet a need, our maid was sent in Haste; my whole is what she went in.
 Behead, transpose, the thing she bought
 Appears, and which she safely brought.
 Curtail, transpose, and take for granted
 You have the end for which 'twas wanted.
 Transpose once more, though strange 'tis true,
 The maiden's name appears in view.

A Charade.

Fair L N promised to bestow
 My first upon her lover,
 And much I hope that no dark clouds
 Around the pair may hover.

Sweet L N's age is just eighteen,
 Of gold she has my second;
 On hearing of the lovely prize
 How many beaux had reckoned!

And now my riddle I'll conclude,
 And hope you'll not me quiz,
 For what I say is very true—
 My whole fair L N is.
 Cipher Answer.—9, 1, 14, 4, 19, 15,
 13, E.

THE MISER'S PUZZLE



PROPOSITION—Tell how much gold the miser has.



MISER WHO HAD hoarded up a quantity of five, ten and twenty-dollar gold pieces used to keep the same in five bags, each of which contained similar coins. While toying with his treasure he would divide it into four piles, each of which would be exactly alike; then, to be certain that none was lost, he would take two of the portions and construct three piles, each containing similar coins.

As by this method it could be told if any coins were missing, it should also be an easy matter to guess the exact amount of his hoard, so we will ask our puzzlists to tell just how much money this poor old man had when he starved to death.

What is a good definition for a muff? It is something or somebody that holds a lady's hand without squeezing it.

GUESS.

To give our young friends another study in geography I will say that there are certain distinctive features or characteristics pertaining to the people of our different States, which are so noticeable to one who has traveled and become familiar with their manners and accents that we unconsciously guess as to the homes of countrymen whom we meet abroad. I was surprised to find that they have the same thing down to a much finer point in Great Britain, and profess to be able to tell from which county a person came just from the tones of his voice. They talk as familiarly there about the little counties as we do about the States here, and are surprised at your ignorance because you do not know of the characteristics of the different sections, and I found that it was considered a great compliment to correctly guess one's native town. Can you discover the home of our friend concealed in the description of the picture?

What is pretty and useful in various ways,
 Though tempting weak mortals to shorten their days,
 Take one letter away, and then will appear
 What youngsters admire every day in the year;
 Take two letters away and then without doubt
 You will be what it is if you don't find it out!
 Glass.



"My good man, are you of Celtia or Kentish origin?"

The Four Elopements

BY SAM LOYD



PROPOSITION—Ferry four jealous couples across the river.

IF COURSE ALL GOOD puzzlists are familiar with the time-honored problem of the countryman who had to ferry a fox, a goose and some corn across a river in a boat which would carry but two at a time. The story of the four elopements, equally old, is built upon similar lines, but presents so many complications that the best or shortest answer seems to have been overlooked by mathematicians and writers on the subject.

It is told that four men eloped with their sweethearts, but in carrying out their plan were compelled to cross a stream in a boat which would hold but two persons at a time. It appears that the young men were so extremely jealous that not one of them would permit his prospective bride to remain at any time in the company of any other man or men unless he was also present.

Nor was any man to get into a boat alone, when there happened to be a girl alone on the island or shore, other than the one to whom he was engaged. This feature of the condition looks as if the girls were also jealous and feared that their fellows

would run off with the wrong girl if they got a chance. Well, be that as it may, the problem is to guess the quickest way to get the whole party across the river according to the conditions imposed. Let us suppose the river to be two hundred yards wide, with the island in the middle. How many trips would the boat make to get the four couples safely across in accordance with the stipulations?

Why is a madman like two men? He is like one beside himself.

Why is your hand like a hardware store? Because it has nails.

Why does a man who runs in debt remind you of a clock? He goes on tick.

Why is a drawn tooth soon forgotten? It is out of your head.

Why is a jailer like a musician? He fingers the keys.

Why is a painted lady like a pirate? She displays false colors.

What relation is your uncle's brother to you, who is not your uncle? Your father.

What class of people might we call those who can't improve? "Mend I cants."

What medicine is a cross dog fond of? Bark and wine (whine).

What is the difference between perseverance and obstinacy? One is a strong will and the other is a strong won't.

What country does a baby cry for? More-rock-oh, or Lapland.

Why is a coat worn by a weather-beaten tramp like a man with insomnia? Because it has not had a nap for a long time.

Why are spiders good correspondents? Because they drop a line by every post and at every house.

What does a young lady become when she ceases to be pensive? Expensive.

What is the sure sign of an early spring? A cat watching a hole in the wall with her back up.

A lady asked a gentleman how old he was? He answered, My age is what you do in everything—excel (XL.)

Why is the world like a cat's tail? Because it is fur to the end of it.

If a two-wheeled wagon is a bicycle, and a three-wheeled wagon is a tricycle, what would you call a five-wheeled one? A V-hicle of course.

THE LAKE PUZZLE

BY SAM LOYD

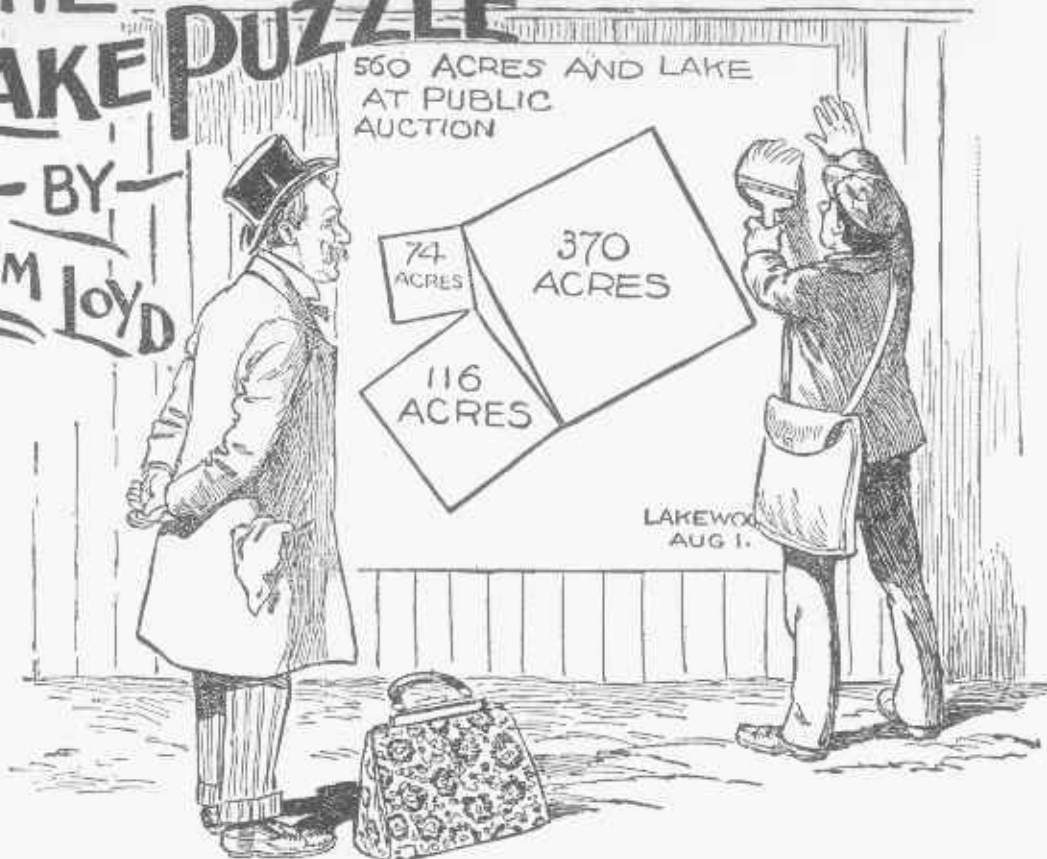

PROPOSITION—Tell how many acres the lake contained.



I WENT TO LAKEWOOD the other day to attend an auction sale of some land, but did not make any purchases on account of a peculiar problem which developed regarding what the buyer would get for his money. It was advertised as shown in the posters on the fence as 560 acres, including a lake. The three plots show up the 560 acres without the lake, but as the lake was included in the sale, I, as well as other would-be purchasers, wished to know whether the lake area was really deducted from the land.

The auctioneer guaranteed 560 acres "more or less," which was not satisfactory to the purchasers, so we left him arguing with some Katy Dids, and shouting to the bullfrogs in the lake, which in reality was a swamp.

The question which I ask our puzzlists who revel in just such questions, is to determine just how many acres there would be in that triangular lake, surrounded as shown by square plots of 370, 116 and 74 acres. The problem is of peculiar interest to those of a mathematical

turn, in that it gives a positive and definite answer to a proposition, which, according to usual methods, produces one of those ever-decreasing, but never-ending decimal fractions.

A CHARADE.

My little criticising first
Is found on either side;
My faithful second guards the crown
With dignity and pride:
My whole delights in summer flowers
And lovely Autumn's fruitful
bowers.
Cypher Ans. 5, 1, 18, 23, 9, 7.

A REBUS.

I am fat and well favoured
When made up complete.
Curtail and you'll find me
Quite wholesome to eat;
Bestore me my tail, and
In lieu take my head,
Like feathers I'm light,
Or as heavy as lead.
Cypher Ans. 16, 12, 21, 13, 16.

A lady wrote on the bottom of a flour barrel: O I C U R M T how did her husband decypher it?

A CHARADE.

When o'er the wave the vessel flies,
Her masts and sails my whole
sustain;
Behold, though vast my length and
size,
I move with swiftness o'er the
plain;
Again behold, come when I will,
The farmer frets and grumbles
still.
Cypher Ans. 19, 20, 18, 9, 14.

A REBUS.

When whole 'tis true, I sometimes
lend my aid—
Nay daily, to the tidy servant maid;
Once take my head, 'twill clearly
then appear
My useful hole is often wanted there;
Transposed, a foreigner I boldly
stand,
Or represent a stretch of land.
Cypher Ans. 2, 18, 15, 15, 13.

A CHARADE.]

My first appears in verse and prose,
My next true merit will disclose;
My whole reveals a poet's name,
Encircled with immortal fame.
Cypher Ans. 23, 15, 18, 4, 19, 23,
15, 18, 20, 8.

BEATING THE RECORD BY SAM LOYD



PROPOSITION—Tell the speed of the horse.

TALKING ABOUT the manner of scoring the time on the quarter miles, in the recent wonderful performance of the trotting queen, Lou Dillon, was struck by an odd little problem which occurred between a couple of the timekeepers, which proved to be too much for their limited knowledge of mathematics.

It appears that the first three-quarters of a mile were trotted in $81\frac{3}{4}$ seconds, while the timekeeper who recorded the finish showed that the last three-quarters were trotted in $81\frac{1}{4}$ seconds, and that the last half of the race was just as fast as the first half.

Despite the paradoxical appearance of there being six quarters to that mile, both timekeepers were correct, but they lacked the services of a clever puzzlist to tell the time for the whole mile. How many of our puzzlists can guess it correctly?

A Study in Hams.

Here is a problem for the juvenile class, which will surely interest the young puzzlists and probably baffle some of the "children of a larger growth."

It appears that a Dutch farmer, who knew more about curing hams than he did about arithmetic, was in the habit of starting out once a

year with a wagon load of hams, which he would sell among his neighbors at wholesale or retail.

The hams were so nearly of a size that he did not trouble himself about weighing them, but sold them at the uniform price of a dollar and a quarter each. He did not like to cut a ham, however, but in order to be accommodating established the rule that he would sell the half of a ham when it was asked for, but would charge double for it. In the innocence of his heart, he did not see that he was charging the same price for half a ham as he asked for a whole one, and as many of his customers knew less than he did about arithmetic, he sold many a half of a ham for what he asked for the whole one.

Well, one day he started off with his load of hams, and the first person he met was so pleased with their appearance that he purchased the half of his stock and half a ham.

He was equally successful with his next customer, who was also a dealer, as he took half of the stock he had left and half a ham, besides directing him to another place where he readily disposed of half of what remained and half a ham.

He then came to a large hotel, the proprietor of which was not at home, but he managed to prevail upon his wife to take half of his

stock and half a ham. He continued on his journey, but had not gone more than a quarter of a mile when he met the hotel proprietor and a friend. The hotel man, not knowing that his wife had purchased any of the hams, took half a ham and the half of what remained, and induced his friend to take half of what was left and half a ham, as it just cleaned out his stock.

Now, what I want our young puzzlists to do is to figure out just how much money this lucky Dutchman received for his hams, and be sure that you don't make a mistake, for the problem was sent to one of our universities and pronounced unsolvable! which would make it rank with the squaring of the circle.

How much money did Hans get for his hams?

A STUDY IN HAMS



PUZZLING PARTNERSHIPS

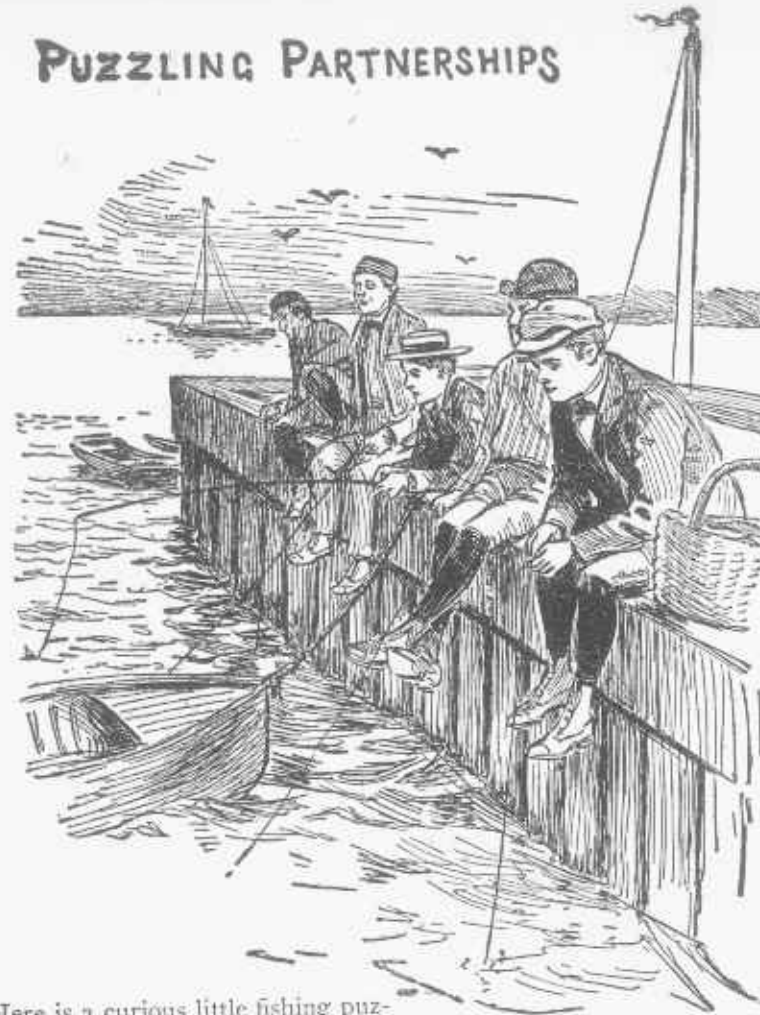

Here is a curious little fishing puzzle which will prove interesting, as it yields readily to experimental methods without much arithmetic, although some who are well versed in figures find difficulty in grasping the situation according to ordinary rules. It appears that five boys whom we will designate as A, B, C, D and E, went fishing, and entered into certain agreements regarding the divisions of the spoils, which solve readily in actual practice when distributing the fishes, but looks like a complicated partnership agreement, as each boy has to pool his luck with the one next to him. It appears that A and B caught 14 fish, B and C 20; C and D 18, D and E 12, while A and E each caught just alike. We will now go into the complications of the separate partnerships and ask our puzzlists to tell from the figures given just how many fishes each caught. It is a puzzling problem to solve mathematically, but in actual practice C just pooled his catch with B and D, and each of them took just one-third. Each one does the same, adds his stock to those of his two side partners, and then divides the same

into three portions until all five are just alike. Can you guess how many fish each boy caught?

A Charade.

An object for which many thousands do sigh,
A blessing I prove, or a curse;
And when to the altar of Hymen you lie,
You take me for better or worse.

I am of both sexes—both husband and wife,
You court me, you love me, you scout me;
I'm the source of much joy, contention and strife,
Yet few can be happy without me.

I travel by land—on the ocean I range,
With the fowls, too, I soar in the air;
I'm constant, I'm fickle—too much given to change,
Therefore, when you choose me, beware!
Cipher Answer.—13, 1, 20, 5.

A Charade.

See how majestic I'm borne!
Behold, some treat me with scorn;
Yet knaves, with all their art and guile,
Deem me too often as a prize.
Restore my head, transpose, what more?
I'm higher than I was before!
Cipher Answer.—13, 1, 3, 5.

What kind of a diary is productive of harm?
Incen-diary.



Here is a pretty problem culled from the notes of two gentlemen of leisure, returned from their summer's outing: Weary Willie, who had outstayed his welcome at Joytown, started for Pleasantville simultaneously with the departure of Dusty Rhodes from Pleasantville. They

met and exchanged the fraternal grip at a point where Willie had gone eighteen miles farther than Dusty. After an affectionate parting, it took Willie thirteen and a half hours to reach Pleasantville, and Dusty twenty-four hours to get to Joytown. How far was it from Pleasantville to Joytown?



PROPOSITION—To change a square into a Greek Cross.



HERE IS A PRETTY cutting puzzle, built upon the lines of the well-known Greek cross puzzle, only it is made more difficult by working the theme backward. In this case you are required to convert a square into a cross instead of a cross into a square, which is not so easy, for the reason that there are no angles and corners to assist you.

The problem is to divide the square into four pieces which will fit together and form a perfect Greek cross.

Lightning Messenger Boys—A Problem for the Juvenile Class.

Harry Nimble, as his name implies, is the most speedy telegraph boy in the city, while Jimmy Pace, can set the pace against all the district messengers in the service. It is not surprising, therefore, that it once so happened that these popular flyers were engaged simultaneously on urgent business. The one was to convey a message from a broker to a customer, telling him that the market was going to smash and that he had better unload his stocks. The other messenger chanced to be from the customer to the same broker, ordering him to clean out

everything at panic prices. The boys met in the park, going in opposite directions, on the full run.

"Hullo, Harry, where you runnin'?"

"Uptown with a special hurry what's yor'n?"

"Downtown, rush. Let's rest. How much money you got? See mine?"

"Gee, what a pile. Let's play a game of poker for fun while we get our wind. I've got the cards, and you can't beat me as you did last time."

"Yes, I kin; come on. We got lots of time." So these two speedy boys seated themselves so as to recuperate their mind, that they might make all the better speed when they resumed their lightning journeys. They were not playing for keeps, and were to readjust their finances at the end of the game.

At one stage of the play Harry had twice as many pennies as he began with, but Jimmy in his impetuous way staked all that he had left in one jack pot and won, so he then had 36 pennies to Harry's 42.

As it was getting too dark to play longer they broke up the card party, straightened out their finances and resumed their mad career. The problem is to tell just how that money was to be divided so that each boy could get back his original number of pennies.

CHARADE.

Crispin, snug in his cobbler's stall,
Waxing his end and driving his awl,
A judge of my first may be reckoned;

For deeds of blood my whole was famed,

But innocence is often blamed;
Transpose a grain for my second.

When does a cow become landed property?
When she's turned into a meadow.

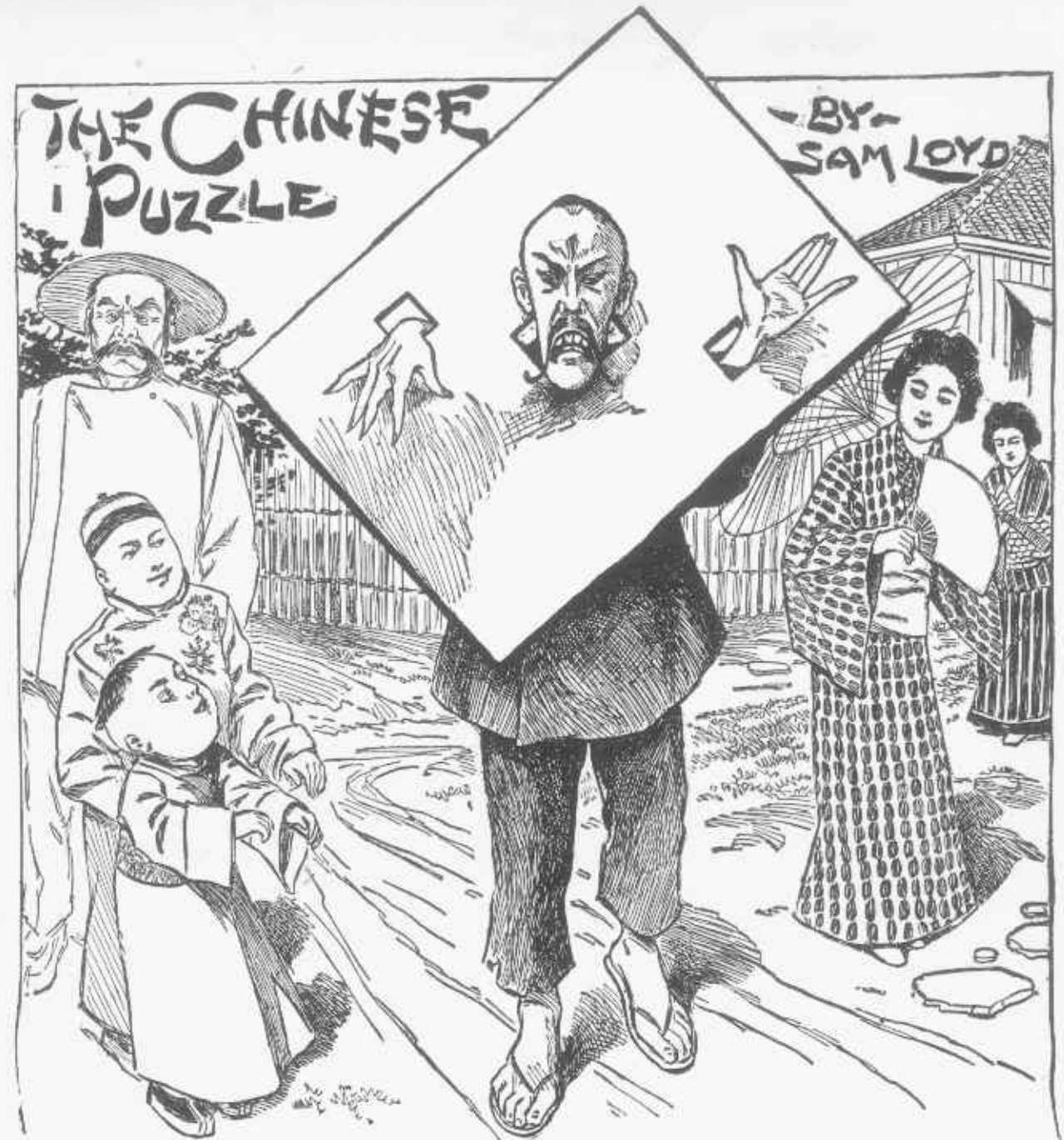

PROPOSITION—Divide a square piece of paper into two halves which will fit together as shown



AW IS ADMINISTERED according to original but impartial lines in the Flowery Kingdom," says a distinguished traveler. "I once saw an accident where the overturning of a platform precipitated a workman from the roof of a lofty building. He struck squarely on the head of a passer-by, who was killed instantly, while the lucky fellow who tumbled nearly a hundred feet escaped without a scratch.

In the above narrative, strange

as it may seem, we find the description and terms of a capital puzzle fully set forth. The stocks, which secure the head and wrists of the unhappy culprit, as shown in the picture, were made from a square piece of wood, which we are told was divided into two pieces. Like all mathematical problems, the proposition can be worked either way, viz., to make a pair of stocks by dividing a square, or to divide the stocks into halves which will fit together and form a square.

The Puzzle.—Take a perfectly

square piece of paper, and, without any waste, cut it into two pieces which will fit together and form an oblong pair of stocks, with openings as shown in the picture, for head and wrists of the culprit. As already ready explained, the two pieces forming the stocks can always be refitted back into a perfect square, with the three openings closed, but there is a pretty trick connected with the feat of producing the holes in the exact positions as shown which will tax one's patience and ingenuity.

Uncle Sam's Fob Chain

BY
SAM LOYD

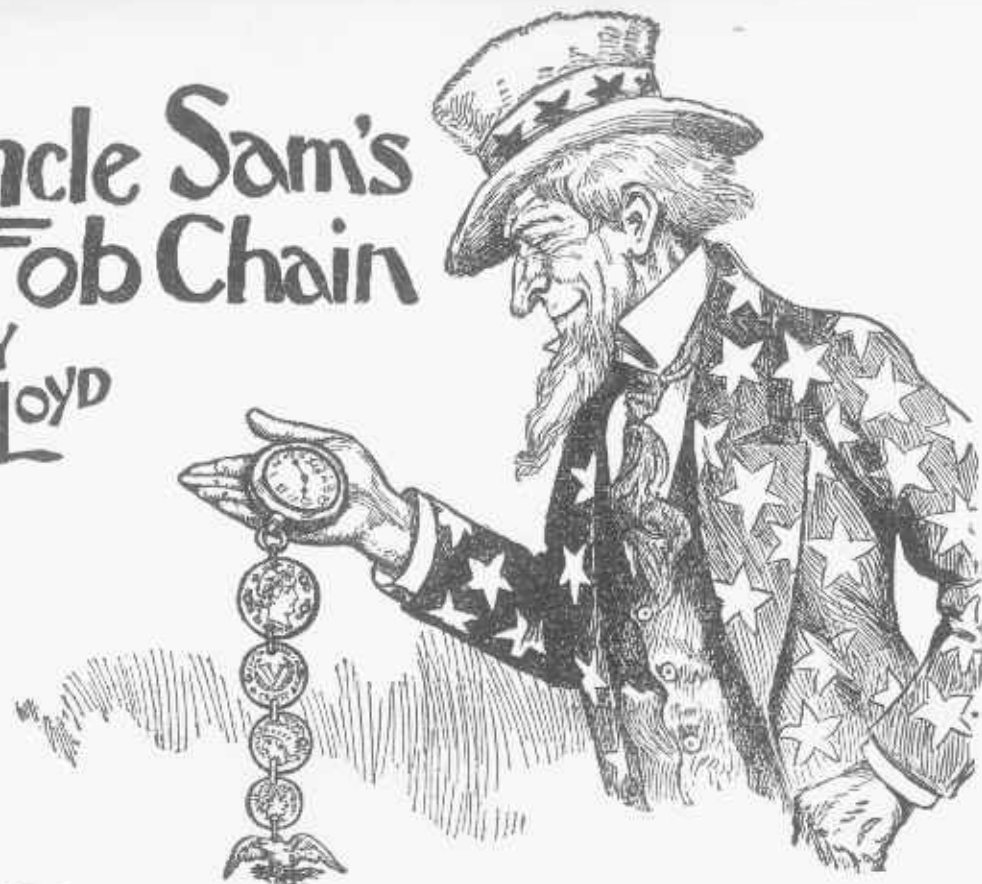

WAS SHOWN A curious fob chain the other day, patterned after the old custom of carrying a string of coins attached to a watch. This particular fob chain consisted of four coins and the figure of an eagle. The coins, as shown, were punched respectively with five, four, three and two holes, so that the small links which joined them together might have been placed differently, so as to have furnished quite a variety of patterns.

This feature of being able to produce a series of fob chains, consisting of a string of four coins connecting the watch and eagle, gave rise to quite a discussion regarding the number of possible arrangements which can be made from the pieces as shown, without any two being exactly similar.

The design has been adopted by the society of Patriotic Americans, which was recently organizer irrespective of party politics to demand respect for the Chief Executive during his term of office.

The chain is built upon a progressive order of presentation, so that each one would be different and could be recognized upon a fellow

member as designating a given number.

The problem of the puzzle is to

determine just how many chains could be made without any two being exactly alike.



"The top of the mornin' to you, Mrs. O'Neill," said Clancy, the mathematical. "Can you tell me why the banana market is like a sunset?"

"I'm not dealing in chestnuts just now, Clancy," replied Widow O'Neill, with a twinkle in her eye, as she recalled the old conundrum,

"but perhaps you can tell me how it is that when I buy yellow bananas at three shillings a bunch and the same number of red ones at four shillings a bunch I would get two more bunches for the same amount if I divided the money evenly between the yellow and red bananas?"

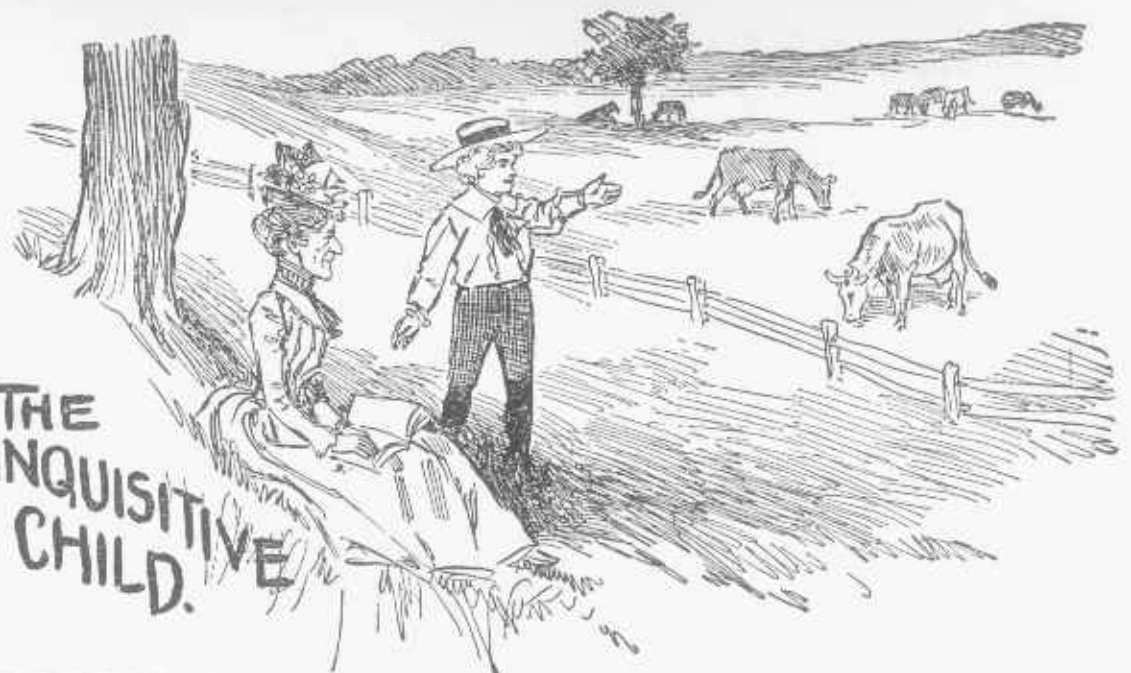

F PARENTS APPRECIATED the benefit of puzzle practice they would encourage everything in the form of conundrums, riddles, problems and puzzles. Familiarity with conundrums paves the way and serves as the stepping stones toward the ability to master and originate clever puzzles. The above simple conundrum is supposed to be asked by a species of human gadfly which had been tormenting his poor aunt with a never-ceasing series of queries: "Aunt Sarah, how do I know that this field is older than you are?"

A CHARADE.

If you a journey ever take,
No matter when or where,
My first you'll surely have to pay,
Before you can get there.
My second you would scarcely see
If London through you go;
But still 'tis what I hope you are;
Few better things I know.
I say my whole with secret pain,
Though hoping soon to meet again
Cypher Ans. 6, 1, 18, 5, 23, 5, 12,
12.

Why do sailors working in brigs make bad servants? Because it is impossible for a man to serve two mast-ers well!

Why are unprotected grates like insolent beggars? Because they are destitute of-fenders.

What notes compose the favorite tunes, and how many do they compose? Bank notes, and they make for-tunes.

No Sale.

During my present summer outing I nipped a prospective sale in the bud in a way that produced a silence that was actually oppressive. I had occasion to patronize a tonsorial artist who was endowed with the usual conversational powers as well as business instincts of his craft, but my mind was so tangled up in the consideration of the problem as to how much greater is four-fourths than one-fourth that I was in no humor for extended conversation; so when he politely suggested: "Your hair is a little thin!" I replied, "not half so thin as your chance of selling me a bottle of patent hair

tonic." I heard him gasp and catch his breath, but he speedily renewed the attack from a different standpoint, meekly saying: "Our bay rum is a little sour from the hot weather!" But again I headed off the entering wedge by remarking: "If your bay rum is sour, you may use good river water!"

That remark was a clincher, and from the long silence I was inclined to think he was working out the secret concealed in my remark. It is a concealed-word puzzle wherein you are to find a geographical lesson hidden in the description of the picture.



THE PUZZLE OF MARTHA'S VINEYARD

—BY—
SAM LOYD



PROPOSITION—How many grape vines can be planted, not closer than nine feet apart, in a square plot containing one-sixteenth of an acre?

REFERRING TO the popular legend of the settlement of Martha's Vineyard, it may be said that there is a possible solution or explanation to the pretty story which is worthy of being given in puzzle form.

It is told how, in Colonial days, one of the sturdy settlers who had undertaken the difficult task of cultivating the rocky soil of that barren island, essayed with the aid of his little daughter Martha, to set out a vineyard. To encourage her, as well as in lieu of other remuneration, he permitted Martha to cultivate for her own use or profit a little square patch containing exactly a sixteenth of an acre of land.

It is said that she planted her vines, according to custom, in rows nine feet apart, and cultivated them just like the others, and yet, as the story goes, her little venture prospered and grew in a way that made Martha's Vineyard noted. She raised more grapes to the acre than any vineyard on the island and

produced many new and valuable varieties, which became famous.

That is all there is to the story when it is reduced to plain facts. Nevertheless, without wishing to impeach Martha's skill nor to question her sweetness which imparted the flavor to her grapes, I wish to engraft a practical problem to her vines which may explain the reason of her wonderful success.

How many grape vines, not closer than nine feet apart, can be set out in a square plot one-sixteenth of an acre in size?

The problem is a pretty one, well calculated to tax the ingenuity and cleverness of our puzzlists and mathematicians, but not to compel a return to the long forgotten school books, occasion is taken to say that an acre is 208 feet and 710-1000 of a foot square, so that a sixteenth of an acre in 52 feet 2 inches square. This you will observe is somewhat different from the popular measurement of 70 yards square which prevails in the rural districts, where a plot 210 feet square is reckoned as an acre.

Why is a naughty school-boy like a postage stamp? Because you lick him with a stick and place him in the corner.

Why is I the luckiest of all the vowels? Because it is in the centre of bliss, while E is in hell and all the others are in purgatory.

What is the longest word in the English language? Smiles, because there is a mile between the first and last letter.

Why have chickens no fear of a future state? Because they have their next world (necks twirled) in this.

Why cannot a deaf man be legally convicted? Because it is unlawful to condemn a man without a hearing.

Why is a man who beats his wife like a thorough-bred horse? Because he's a perfect brute.

What is that which you can keep after giving to some one else? Your word.

Why are dealers in glassware unlike all other dealers? Because it won't do for them to crack up their goods.



COUNTING CHICKENS BEFORE THEY ARE HATCHED

BY
SAM LOYD

PROPOSITION—How many chickens must one start with to have 6468 at the end of three years?



THE ADVANTAGE OF being able to estimate with absolute correctness the profits resulting from an incubating venture so as to lay one's future plans with safety is illustrated in this interesting puzzle.

"If you should marry that worthless fellow," exclaimed the irate father, "what do you expect to live upon?"

"My dear papa," replied his daughter, "Claude has got it all planned and figured out. He is going to buy some chickens this spring and raise so many broods of young chickens that in the fall we can sell enough of the surplus gentlemen chicken for us to get married on. We will sell enough at the end of the second year to pay our housekeeping expenses, and on the third year we will have 6468 chickens! Which we will dispose of so as to pay off that \$3,000 mortgage on the house, which worries you so much."

The data seems to be somewhat vague, nevertheless, allowing for the enthusiasm which is a part of love's young dream, we must as-

sume certain averages and ratios are to be maintained throughout the entire enterprise so as to produce the result claimed.

It need only be said that after a careful examination of the calculations which the young couple had made on the other side of that paper, the stern papa relented and gave his consent, so the wedding took place and the mortgage was paid off on schedule time, besides leaving a little surplus for contingencies which developd. For the benefit of other young couples contemplating similar ventures we ask our puzzlists to tell just how many chickens they must have had to start with.

What is the first thing a man sets in his garden? His foot.

Why does a bachelor who has a counterfeit half dollar passed on him want to get married? To get a better half.

Why do we generally dub a city her or she? Because about a city there is so much bustle and because she has outskirts.

Why are washwomen great flirts? Because they wring men's bosoms.

Why does a hair-dresser die a sad death? Because he curls up and dies (dyes).

If thirty-two degrees is freezing point, what is squeezing point? Two in the shade.

Prove that the winds are blind. The wind is a zephyr, a zephyr is a yarn, a yarn is a story, a story is a tale, a tale is an attachment, an attachment is love, and love is blind; therefore, the winds are blind.

Why is a married man like a fire? Because he provokes his wife by going out at night.

Why is a pig's brain larger than any other animal's? Because he has a hog's head full.

What is the difference between a young lady and a mouse? One charms the he's, the other harms the cheese.

Why is Patti like a jeweler? Because she deals in precious stons (precious stones).

When is a bee a great nuisance? When it is a humbug.

What is the difference between a gardener and a Chinaman? One keeps the lawn wet, the other keeps the lawn dry (laundry).

THE YACHT RACE BY SAM LOYD

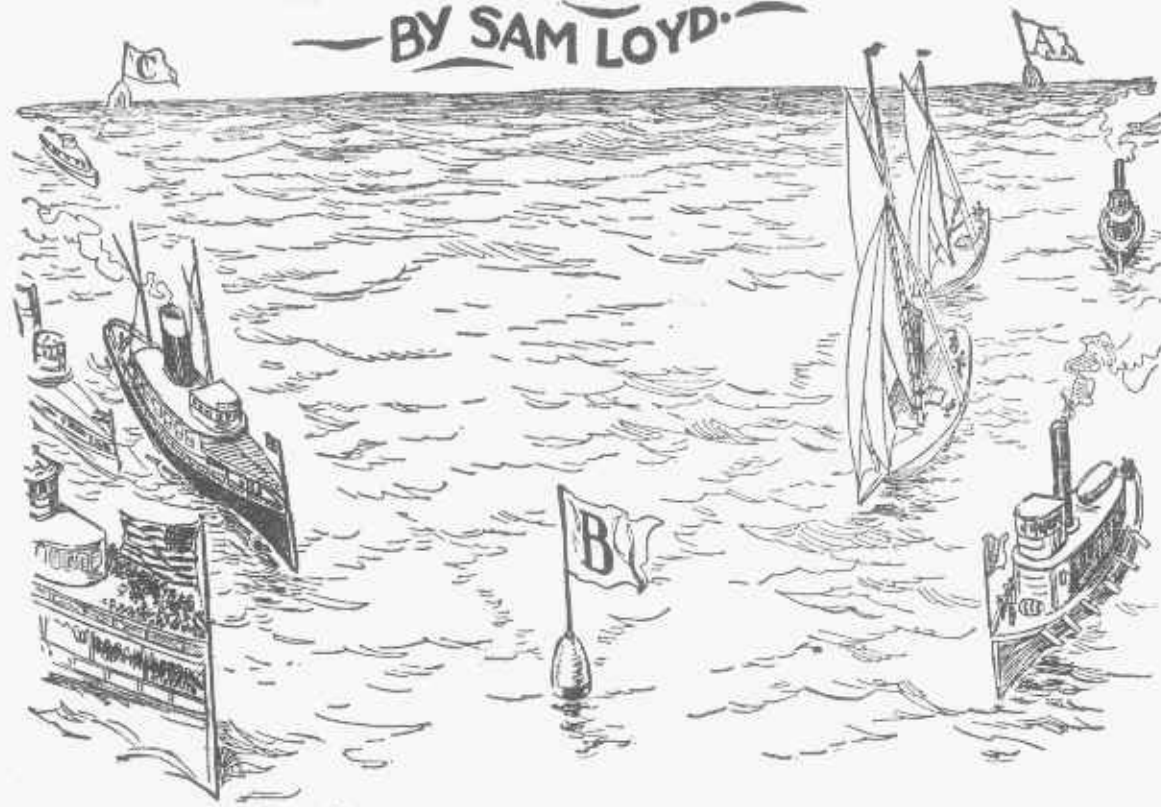

PROPOSITION—Give the correct time of this race.

AS A TIMELY TOPIC of the hour we will ask our puzzlists to come to the aid of three land lubbers who know so little about nautical matters that they are all at sea over a little problem pertaining to the international yacht race.

They endeavored to keep exact tab on the speed of the boat, but not being very good sailors, Father Neptune interfered somewhat with their observations, so their log book shows that their account of the race is divided into two dog watches, the one overlapping the other. Smith, who had charge of the first dog watch, failed to record the exact hour of starting, but reports that the boat sailed the first three-quarters of the race in three and a half hours, at which stage of the game he retired, owing to seasickness. Jones, who had charge of the last dog watch, records that the last three-quarters of the race were sailed in four and a half hours, while Brown, who had charge of the middle watch, was so anxious to reach land that he only noted that the middle leg of

the race was ten minutes slower than the first.

To some people it may look as if there were six quarters to the race, but as puzzlists are not disturbed by such trifles, any explanation would be superfluous. You see it was a triangular course, of ten miles to each leg, although that is immaterial as the gist of our problem turns upon the time consumed between the buoys A, B, and C, irrespective of the distance. At what hour did the race end, if the boats started at nine minutes past ten?

A PUZZLE.

Express with four letters a sentence of four words containing fourteen letters? Ans. I O U O.

There was a man who was not born,
His father was not born before him,
He did not live, he did not die,
And his epitaph is not o'er him?
Ans. The man's name was Not.

Why is a note of hand like a rosebud? Because it is matured by falling dew (dew).

A REBUS.

My first it is a curious thing,
Of Nature's own produce,
And many who have lost a limb
Have found it of great use.

By my second's wondrous skill
Ships are made with ease,
To stem against both wind and tide
Across the boundless seas,
My whole is very often found
Together with my first,
And comes in very handy
When you would quench your thirst.

Cypher Ans. 3, 15, 18, 11, 19, 3, 18, 5, 23.

My first is a female,
My second the same,
My whole is much dreaded—
Pray what is its name?
Ma-lady.

How would you express in one word that you had met your doctor?
Met-a-physician.

Why is a blush an anomaly? Because a woman who blushes is admired for her cheek.

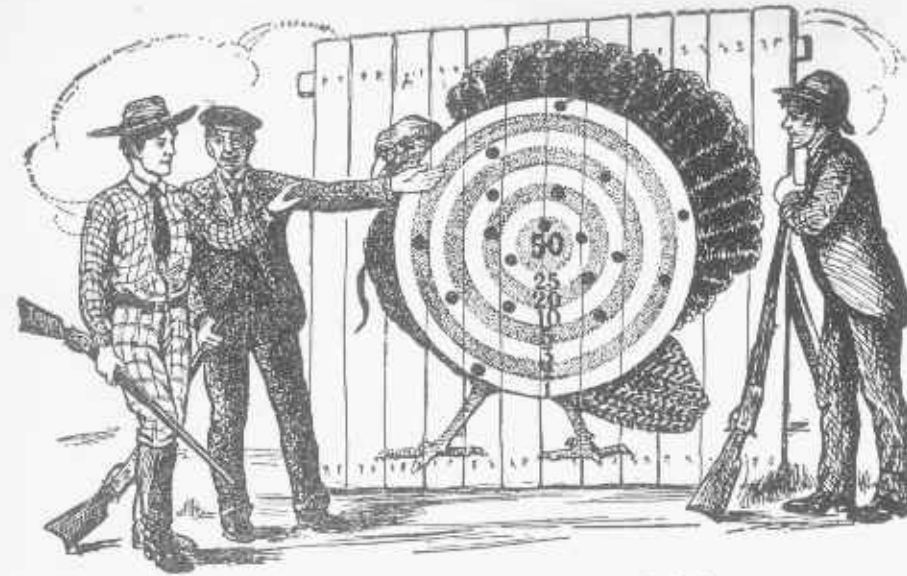

A Rebus

Here is a Thanksgiving Day puzzle representing a turkey shoot in which I once participated in the "wild and woolly West." It was for a prize of a fat turkey and I remember that we all made tie scores. Each had six shots and made seventy-one points apiece, as you will see if you add up the hits as indicated by the number in the rings on the target. I remember that the score made quite a respectable puzzle, for the reason that it requires some little ingenuity to pick out the six counts which each one must have made if we made tie scores.

A Charade

My first may be borne by some sorrowful hack,
Which adds to his cares and the sores on his back;
But ah! should he feel all the weight of my second,
His misery, nearly complete, may be reckoned;
My whole often adds to your pleasure or pest;
No more need I say—you'll soon find the rest.
Cypher Answer.—16, 1, 3, 11, 1, 7, 5.

A Rebus

My first's a well-known cruel rogue
Who lives by deeds of fraud;
My second's often in your hand
When you would walk abroad.
My whole may frequently be found
In fields where beauties bloom around.
Cypher Answer.—6, 15, 23, 7, 12, 15, 12, 5.

A Rebus

Seeking my first, as once fair Biddy hied
And paced the verdant meads with maiden pride;
Paddy perchance my lovely second viewed,
And stole a kiss, and then for pardon sued;
Then of my whole he made a neat boquet,
And coaxed her then to name the wedding day.
Cypher Answer.—3, 15, 23, 19, 12, 9, 16, 19.

A Charade

My first's a sign of pain,
Of sorrow, or surprise:
My second, it is plain
Within your kitchen lies.

My whole is found in Spain,
'Neath genial southern skies,
A fruit—but I'll refrain,
And leave it in disguise.

Cypher Answer.—15, 18, 1, 14, 7, 5.

A Rebus

Decapitate, and what of me
Remains behind is still before;
Curtail my last, well pleased to see
The prudent still provide a store.
Curtailed again, my head replace,
See me on Israel's border stand;
My whole a poet's name display
Whose fame is known in every land.
Cypher Answer.—4, 1, 14, 20, 5.

Drop Letter Puzzle From Tennyson. Every Vowel Omitted.

T. b. wr w. th .n. w. l. v.
D.th w.rk l.k. m. dn.ss .n th.
br..n.

SAM LOYD'S DIRECTOR'S PUZZLE



"Gentlemen," said Chauncey, at a recent directors' meeting, "the present income from the earnings of the road would pay 6 per cent. upon the entire stock issue, but as there is \$4,000,000 of preferred stock upon

which we pay 7½ per cent. interest we are therefore only able to pay 5 per cent. interest upon the common stock." From these facts you are asked to tell the amount of the common stock.

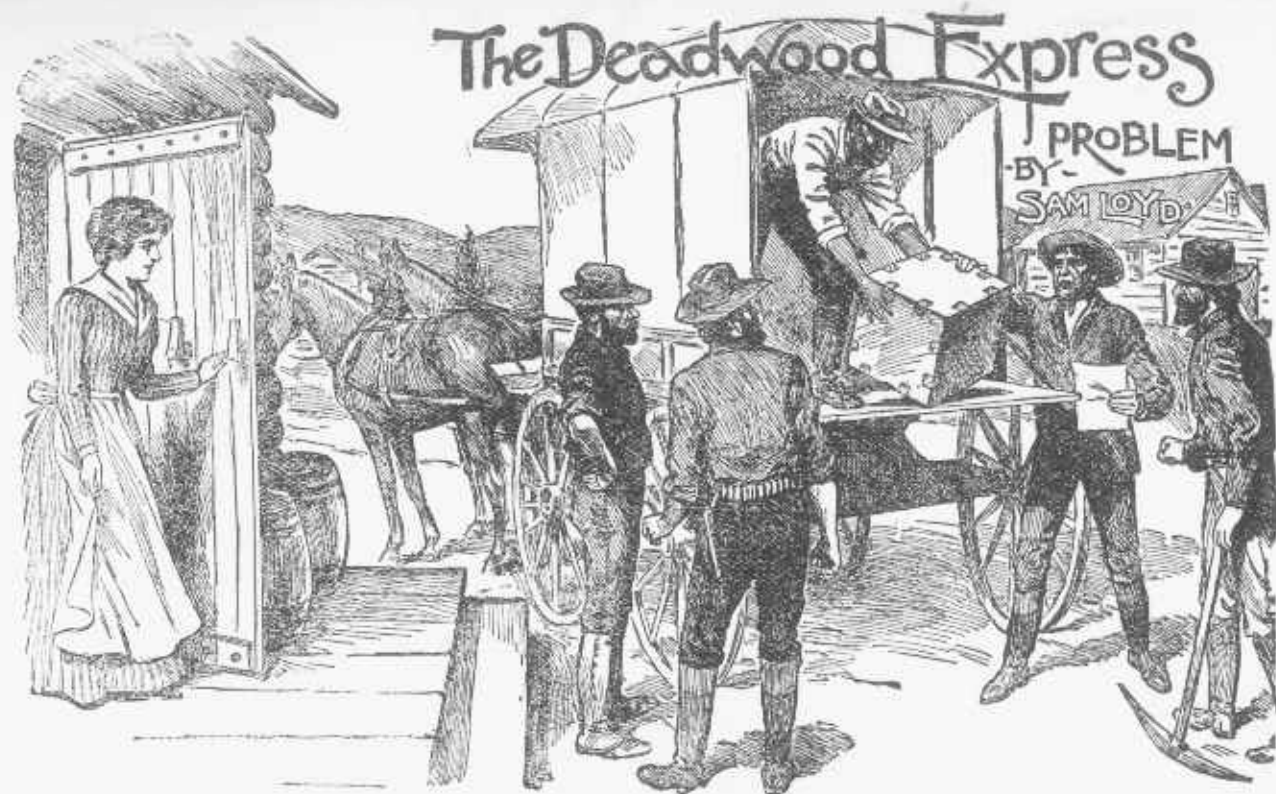

PROPOSITION—Tell the size of the two square boxes that came by express.

HERE IS A COMPANION piece to the plumber's tank problem which illustrates a very puzzling point in practical mechanics.

The sketch represents a scene in the wild and woolly West as the Deadwood Express arrives at the gold diggings with a consignment of two boxes for the young lady, and her admirers are having a lively dispute with the expressman as to the proper charges for the same.

There are two boxes, one of which is in view and the other concealed in the wagon.

The point is that the expressman wished to charge for the boxes at the rate of \$5 per cubical foot, as per his instructions on the freight bill. The miners, however, strenuously objected on the grounds that their custom was invariably to pay so much per running foot—according to mining laws and they could not see what right an express company had to meddle with the "cubical contents" of a young lady's box, any way!

The expressman was compelled to accept the proposed terms, so he measured the length of the boxes and charged \$5 per running foot.

The boxes are perfectly square

and one is exactly half the height of the other.

The strange part of the problem is that when the expressman placed the two boxes together and measured their combined length it was found that there was not the thousandth part of a cent difference in the ways of charging—at \$5 per cubical foot or at \$5 per running foot.

What were the sizes of the two boxes?

It is a simple, yet very interesting puzzle, which will cause the gray matter in the brains of our mathematicians to circulate somewhat before hitting upon the proper way to handle these express boxes.

An Odd Trick.

Here is a pretty way of telling in which hand a person holds an odd or even number of coins, which, if well understood by the performer, so that he can vary the same, may be shown very effectively.

Tell a person to hold an even number of coins in one hand, an odd number in the other, and you will find out which hand holds the odd number.

You tell him to multiply the number in his right hand by any odd

number, and to multiply the number in his left hand by any even number and tell you how much it amounts to. You may now go into some hokus-pocus calculation or explanation regarding the figures mentioned, which will mystify him, but all you need to note is whether the sum mentioned is odd or even as it tells whether the sum in his right hand is odd or even. If he said 792 you know that he holds an even number of coins in his right hand. If he should say 551, his right hand holds an odd number, and as a matter of course the left hand holds the reverse.

By changing the order, and sometimes telling him to multiply the number in his left hand by an odd number, which would reverse your reply, you can conceal the trick. Another way is to say, "Take an odd number of coins in one hand, an even number in the other. Now treble the number in the right hand and double the quantity in the left, and tell me how many there would then be."

Why are hogs like trees? Because they root for a living.

Why is a four-quart jar like a lady's side-saddle? Because it holds a gal-on (gallon).

The Reaper's Problem

BY SAM LOYD.



PROPOSITION—Tell the width of a strip around a field which will take half of the field.

AS SHOWING HOW mechanics and laborers having no knowledge of mathematics will often solve, in a practical way, some very difficult problems, I will call the attention of our puzzlists to the clever way in which a couple of farmers adjusted their affairs.

A Texas ranchman, who owned more land than he could conveniently farm, leased certain fields to a neighbor, who agreed to work them on shares. One particular field was two thousand yards long by one thousand deep, but as there were certain bad streaks running through the land it was decided that a fairer average would be given to each man by cutting a band completely around the field than by dividing it into halves.

I presume our puzzlists will find no great difficulty in guessing the width of the strip which must be cut all around that field to get just half the crop of wheat, and to discover a simple rule which will always apply to any rectangular field of any dimensions which that farmer in the checked shirt looks as if he could apply to the other fields.

What is the most difficult lock to pick? One from a bald head.

Why is snow like a maple tree? Because it leaves in the early spring.

Who is the first nobleman mentioned in the Bible? Baron (barren) figtree.

If a man bumped his head against the top of the room, what article of stationery would he get? Ceiling whacks. (sealing wax).

What is a good thing to part with? A comb.

If your uncle's sister is not your aunt what relation is she to you? Your mother.

Why has a chambermaid more lives than a cat? Because each morning she returns to dust.

Why ought the coachman become wealthy? Because he does a driving business.

Why do carpenters have great faith in sooth-sayers? They cannot work without an augur (augur).

What does a yawning policeman resemble? An open-faced watch.

Why is a crow like a lawyer? He likes to have his caws (cause) heard.

Why are umbrellas like good churchmen? They keep Lent so well.

Why is a nice, but uncultured girl like brown sugar? Because she is sweet but unrefined.

Why are eccentric women like tea-kettles? Because they sing away pleasantly and then all at once boil over.

How would you keep fish from smelling? Cut off their noses.

Why should you never confide a secret to your relatives? Because blood will tell.

Which nation produces the most marriages? Fascination.

Why is a bridegroom often more expensive than a bride? Because the bride is given away, but the groom is often sold.

Why is divinity the easiest of all professions? Because it is easier to preach than to practice.

When is love deformed? When it is all on one side.

When was B the first letter in the alphabet? In the days of No-a (Noah).

Why is it right for B to come before C? Because we must B before we can C.

Why is a windy orator like a whale? Because he often rises to spout.

Sam Loyd's Endless Chain Puzzle.

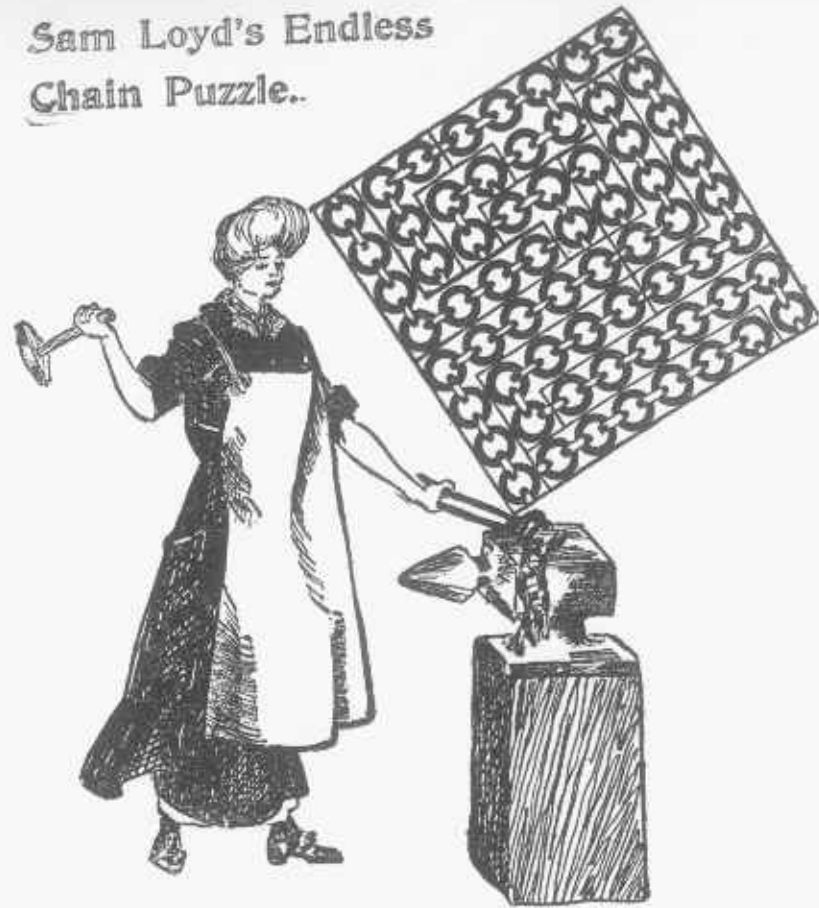

Here is a puzzle which taxed the ingenuity of the pretty little French blacksmith. She received a box containing thirteen pieces of chain which she was to mend and return in the same box. You are not asked to do the joining and welding, but merely to show how the chain appeared when packed in the box. You can see that some of the pieces do not fit together as now placed. So take thirteen pieces similar to those shown and find how they can be packed so as to appear mended.

Here are some simple studies in concealed geography for the juvenile class:

172. We shall have nice cake for tea.
 173. Do you like your poetry in Iambic or in the Trochaic metre?
 174. Agatha's tooth aches; dismal Agatha.
 175. We have borne war; kings can do no more.
 176. After this refusal, a man called Tinder popped the question.
 177. She called it a cabal, because she is a ninny.
 178. I have lost my opal, my rather uncommon opal.

179. Arisel ring a-pat a merry peal.
 180. Queen Elizabeth said awful things.
 181. Adoniram is so long hindering Jacob.
 182. March in a line. (Country.)
 183. I said to her, O mercy! what's the matter?
 184. Eliza then said to me, I have sprained my ankle.

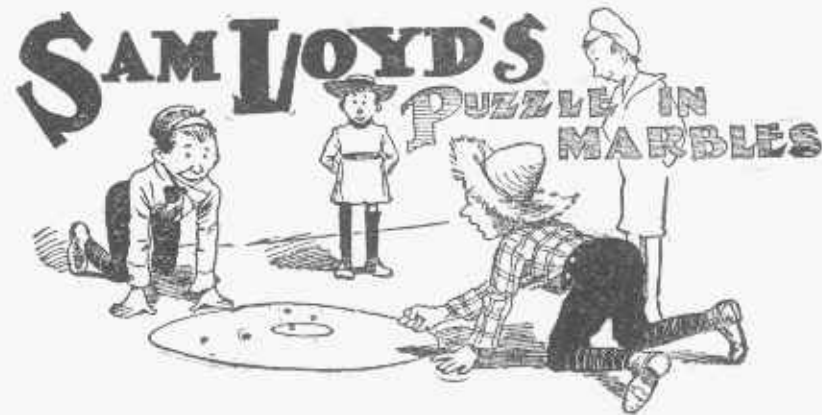

Harry and Jim, two rival marble shooters, started in to play for keeps when each had the same number of marbles. Harry won twenty in the

185. I would rather ride under an elephant than over a rat.
 186. I gave my apple to John, he gave his to William.
 187. I have often seen a woman ride on a bicycle, but never on an icicle.
 188. George Bergen evaded the enemy.
 189. Which name do you prefer, Loring or Hamilton?
 190. Shall you be at Holyoke this summer?
 191. Neither woman nor man dyed their hair in the middle ages. (Province.)
 192. He smote himself upon his chest, erring and weak King Charles.
 193. Such a color! a downright brick-color. (River.)
 194. She brought a bottle of myrrh in each hand. Myrrh! Oh, never touch that. (Rivers.)

A Rebus

My first is a substance both pleasant and good,
 And its use by the ladies is well understood;
 My next, ever moving, so light and so trim,
 Of delicate structure in both body and limb;
 My whole, shall I tell you how brilliant and gay,
 How vainly it flutters, how short is its day,
 How just is the emblem, frail man has his prime,
 How soon metamorphosed, and changed by time.

Cipher Answer.—2, 21, 20, 20, 5, 18, 6, 12, 25.

first round, but lost two-thirds of his stock in the play-off, which left Jim four times as many as Harry. Can you tell how many marbles each had when they commenced to play?

THE BATTLE OF HASTINGS A PUZZLE OF SQUARES



PROPOSITION—How many men had Harold?



ALL STUDENTS OF history know of the mystery and uncertainty concerning the details of the ever-memorable battle which occurred on the fateful October 14, 1066. This week's puzzle deals with a curious passage from ancient history which has not received the attention it deserves. The passage in question, as pointed out by Professor Dudeney, says: "The men of Harold stood well together, as their wont was, and formed thirteen squares, with a like number of men in every square thereof, and woe to the hardy Norman who ventured to enter their redoubts, for a single blow of a Saxon war-hatchet would break his lance and cut through his coat of mail. * * * When Harold threw himself into the fray the Saxons were one mighty square of men, shouting the battle cries of 'Ut! Olicrosse! Godemite!' Contemporary authorities agree that the Saxons did actually fight in that solid order. In the "Carmen de Bello Hastingensi," a poem attributed to Guy Bishop of Amiens, it tells how "the Saxons stood fixed in a dense mass."

And Henry of Huntington speaks of "the square like unto a castle, impenetrable to the Normans." Robert Wace, a century later, confirms the arrangement of the forces in a way that suggests a possible solution to the mystery concerning the actual number of men engaged in the battle. So let us look for a literal and exact answer to the proposition, that if Harold's forces were divided into thirteen squares, which, when he added himself to the number, could be arranged into one large square, the proposition is a simple one. How many men must there have been? but the puzzle is so difficult that it is safe to say that few mathematicians will solve it correctly, so I shall present it now in the shape of a guessing match, and ask all our puzzlists to guess a number which will come the closest to the number of men engaged in that memorable battle.

A REBUS.

An emblem of stupidity,
 My first in forest found;
 Up in air oft rises high,
 Though fastened in the ground.
 But by sharp means it is removed,

And managed various ways;
 By art or skill it is improved,
 Or, perhaps it makes a blaze.
 My second is of every kind,
 Is good, or bad, or gay;
 Is dull or bright, to suit all minds,
 By night as well as day.
 The patient seaman keeps with care my whole,
 And well it knows its secrets night and day;
 And though it has no tongue, nor heart, nor soul,
 It tells the story of the ship's long way.
 Cypher Ans. 12, 15, 7, 2, 15, 15, 11.

CHARADE.

My first is a creature of wonderful form;
 My second gives shelter in sunshine and storm;
 The empire of Flora embraces my whole;
 Entire you may find me where sea-billows roll.

Which is the most cheerful part of an arsenal? The ball-room.
 Why is a magnificent house like a book of anecdotes? Because it is made up of good stories.



Little Tommy Riddles calls King Puzzlepate's attention away from the agreeable task of "sitting in the counting room counting up his money" to mention the catastrophe of the maid losing her nose while hanging up the family laundry. He then propounds Mother Goose's great riddle of:

"Twice four and twenty blackbirds are sitting in the rain,
One shot killed a seventh! How many did remain?"

Tommy says the Queen gave him a piece of bread and honey for his clever answer to that puzzle.

The head cook demands an audience to explain how the famous baked pie containing four and twenty blackbirds can be cut in two halves of the same shape and size, each containing a dozen birds, so that when the pie is opened the birds, not being hurt by the cutting, will all begin to sing.

A Charade.

Behold my first in sable hue,
View it again, an azure blue;
Sometimes carnation's not more bright,
Again it seems a milky white.
My second, I must make confession,
Is a most choice and rich possession.
Which all enjoy; for rich and poor
Possess alike this valued store.
My whole is sometimes formed by
lead,
And vertic rises o'er our head.

A Charade.

My first is what you're doing now,
My second is procured from stone;
Before my whole you often stand,
But mostly when you are alone.

A Crow Conundrum.

Not only have birds a language of their own, but according to Professor Du Point, who has made the language of birds a life study, they sometimes say very clever things

and are especially partial to conundrums. He recently overheard the following little bird gossip between two croakers on Long Island:

"Said one old crow unto his mate,
I notice lovers stay out late;
In childhood's hours 'twas ever thus,
Now tell me why are they like us?"

The Professor is very desirous of obtaining the correct solution to this conundrum. Who will send in the best answer and so please the heart of the puzzled Professor?

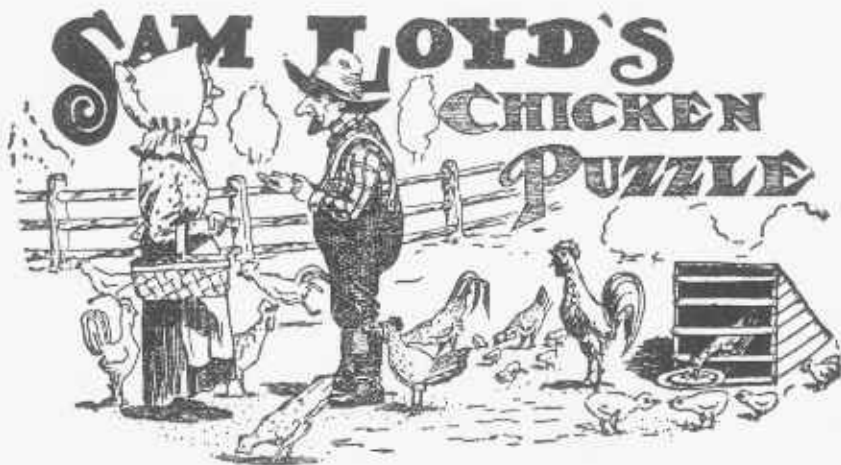

While discussing practical ways and means with his good wife, Farmer Jones said:

"Now, Mariah, if we should sell off seventy-five chickens, as I propose, our stock of feed would last just twenty days longer, while if we

should buy a hundred extra fowl, as you suggest, we would run out of chicken feed fifteen days sooner."

"Well, now, Josiah, how many chickens have we, anyhow?"

That's the problem—how many chickens had they, anyhow?



As announced by Tommy Riddles, the court page, King Puzzlepate is holding high court and shows how justice is administered in Puzzleland so as to make the punishment fit the crime. A stupid boor, who could not see the point of the old conundrum: "When is a door not a door?" was condemned to be pilloried with the door about his neck and wrists until he discovered how to divide the board into two pieces which will fit together so as to form a perfect square. How many of our clever puzzlists can solve this unique trick of cutting the board into two halves which will release the culprit, and then fit the pieces together so as to make a perfect square, with the three holes closed up?

Princess Enigma is shown explaining to a couple of quarrelsome merchants, who are disputing the ownership of a marvelous Persian rug, that they will be consigned to prison until they discover how, by cutting on the lines, so as to divide the rug into two pieces of the same shape and size, without destroying any of the patterns. This puzzle was given to demonstrate that any symmetrical form can only be divided into similar halves by a line from one side to the other, passing through the

exact center. If the line from the starting point to center is irregular, then its shape must be duplicated (in reverse) from the center to the ending. This rule furnishes the groundwork for some excellent puzzles.

A Charade.

My first's a portion of a book,
One of the insect tribe my second;
Whene'er upon my whole you look,
A splendid show it must be reckon'd.

SUBSTITUTION PUZZLE

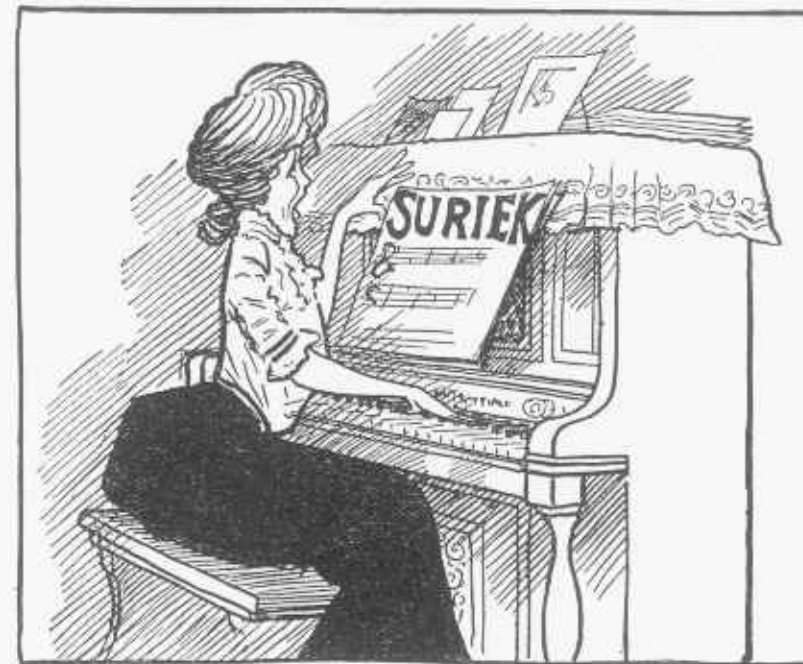

By changing one letter in this Greek ballad you will know the name by which it is termed by all of the tenants in an uptown apartment house.



Little Tommy Riddles announces that King Puzzlepate and the Princess Enigma are investigating the secrets of the famous seal of King Solomon, which is engraved upon the royal tomb. The Puzzle King is engaged upon the first puzzle, which consists in figuring out just how many equilateral triangles are to be found in the design of the pyramid. The Princess is engaged upon another puzzle, endeavoring to master the best method of drawing the design of the seal in the fewest possible number of straight lines without removing her pencil from the paper. In other words, the design is to be made with one continuous line, consisting of straight strokes, although it is not prohibited to go over a stroke twice. The point is, to complete the sketch in the fewest number of turns.

According to "Notes and Queries," the old phrase, "as difficult as to give the first cost of a lobster," originated in the House of Representatives during the bitter war over protective tariff between John Quincy Adams and Andrew Jackson, in 1829, when the latter was elected in opposition to what was known as the "American system."

During a debate regarding the placing of a tax upon the first cost

of raw material a Representative of one of the Eastern States wished to know how they would calculate the first cost of the lobster, which was doubtless an important branch of Eastern commerce, and the phrase became one of ridicule against the protectionists.

The member when pressed to tell what he knew about the price of lobsters could only say that "prices varied, but the original lobster catchers receive as much for six dozen lobsters as they get lobsters for thirty-two shillings." The members were

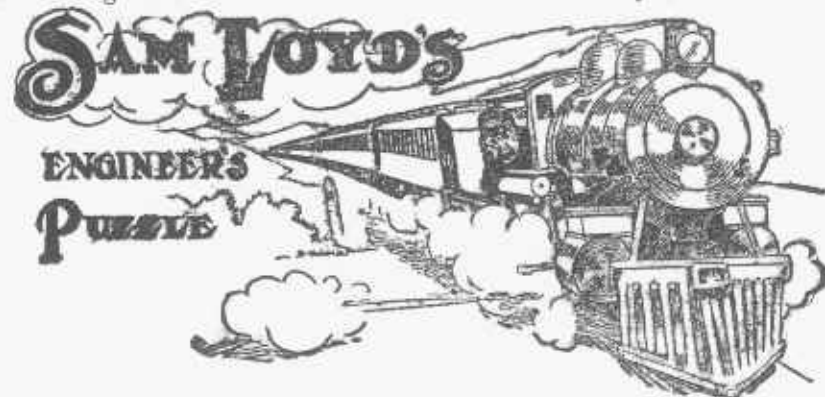

Big Jim, engineer of the Owl Express, says: "We blew off a cylinder head an hour after leaving the station and had to continue the trip at three-fifths of the former speed,

not given to mathematics so few if any were able to figure out "What is the first cost of a lobster?" Can you give the answer to the clever puzzle?

A Charade.

Brave conquerors in my first—of old,
Where drawn from battle home;
Out of my second, silver, gold,
And copper too do come.
The lady who looks wan thro' years,
Whose face no redness shows;
By using of my whole appears
As fresh as any rose.

which brought us in two hours late. If the accident had occurred fifty miles farther on, the train would have arrived forty minutes sooner." How long was the run between stations?

PUZZLELAND GINGERBREAD.



To show how the clever people of Puzzleland, like everybody else all over the world, try to get the better of a bargain, it may be mentioned that ginger-bread is always made in odd shapes, marked off in so many little squares for a penny. But there is always a puzzle connected with ginger-bread in Puzzleland which gives purchasers a chance to win the whole cake for nothing. This puzzle is to find how to cut the cake on the lines in two pieces which can be fitted together so as to form an 8x8 square!

Then, as usual, there is a second problem connected with the ginger-bread exhibit which you are asked to guess. Each of the children has a nickel and the funny old saleslady offers to let each of them take as big a piece for the nickel as can be marked off provided that each one of them gets a piece containing just as many of the little squares as the other purchaser.

Like all good children they were very clever at puzzles and got good big pieces, but you will find it quite a puzzling problem to tell just how many of the small squares each got for a nickel.

A Charade.

Productions first of various good,
For man and beast supplying food;
My next th' effect of cold or fear,
Or from the feather'd tribe we hear;
My whole strikes terror to the heart,
And awful rends my first apart.

A Charade.

My first, ye fair, adorns your head,
You wear not any thing instead;
Within the convent's gloomy walls,
My second to devotion calls;
In July's eve, my whole is sound,
Decking, with azure tint, the ground

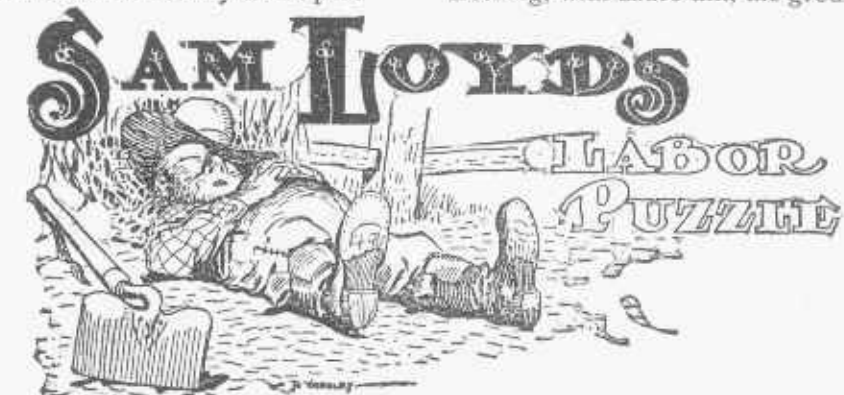

I asked Bill Sykes if he wanted to work, and he asked, "Why should I work?" "To earn money," I replied. "What's the use of earning money?" he said. "To save it up," I replied. "But what do I want to save money for?" he asked. "So that when you grow old you can rest," says I. "But I am growing old as fast as I wish now," says he, "and what's the use of working to rest

when I can begin to rest right now?" I failed to convince him, but I got him to contract to just try for 30 days at 16 shillings a day, but stipulated that he would forfeit 20 shillings for every day he idled. At the end of the month, neither owed the other anything, which convinced Bill of the folly of labor. Can you tell just how much work Bill accomplished?

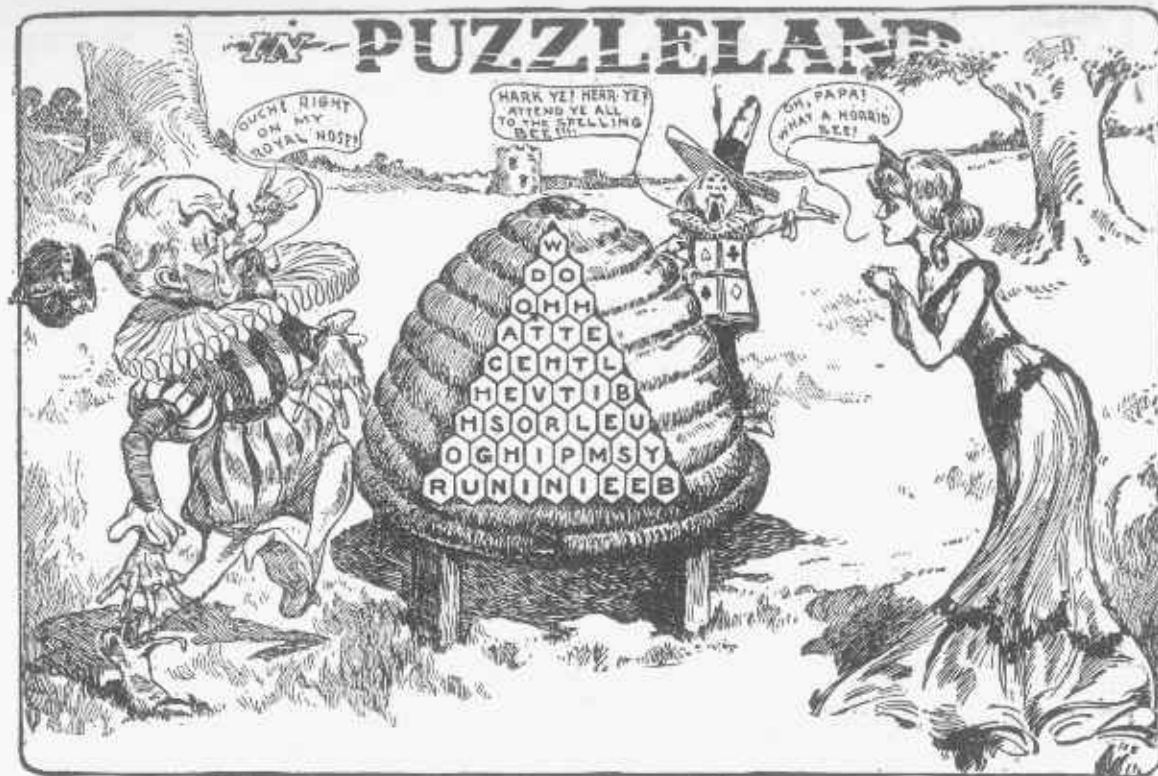

Tommy Riddles calls attention to a wonderful educated spelling bee, which has been trained to perform all sorts of interesting tricks. You will observe that each of the 45 cells contains a letter, so that the intelligent bee starting from a certain letter, can pass in a continuous line over the 45 letters and spell out a little couplet with which everybody is familiar. Can you figure out the route which spells out the hidden sentence?

The second puzzle is somewhat different. The bee enters the door, and beginning at one of the lower cells, passes over all of the other cells in straight lines, ending up at the top cell, having followed a route which required the fewest possible number of turning points.

When Longfellow, the poet, held the professorship of modern languages at Harvard College, he frequently referred to the possibility of clothing mathematical problems in more attractive guise, so as to interest the students. He was fond of mathematical studies himself, and in pursuance of his plans suggested some very interesting and clever problems, which were afterward embodied in his work entitled "Kavanaugh." The few specimens of his mathematical skill introduced in the book named are the only problems

which have been preserved. One elementary proposition which will interest our young puzzlists is as follows:

If one-fifth of a hive of bees flew to the ladamba flower, one-third flew to the slandbara; three times the difference of these two numbers flew to an arbor, and one bee continued to fly about, attracted on each side by the fragrant ketaki and the malati. What was the number of bees?

A Charade.

My first is sometimes white as milk,

And often is composed of silk; And though it's somewhat like a fable,

Again its color is a sable. To make the wonder still more rare, I've often seen it made of hair. So you'll find out without much pains

'Tis not far distant from the brains. My second, I must now reveal, Is formed my former to conceal; My first and second now connect, And then my charade you'll inspect.



The Chinese revel in mathematics, and every merchant is an expert juggler in figures as well as weights and measures. Here is a puzzle in mixed tea which a Hong Kong shopkeeper sprung on a member of the Taft Party during its sojourn in the Flowery Kingdom. It seems that the

"Chink" sold a popular mixture of two kinds of tea, one of which cost him five "bits" the pound and the other three "bits." He mixed up forty pounds, which he sold for six "bits" per pound, gaining a profit of 33 1-3 per cent. Now can you tell how many pounds of the five "bit" tea he used in the mixture?

THE MATHEMATICAL MILKMAN OF PUZZLELAND



Our puzzlists are here treated to one of those every-day little problems with which all good citizens of Puzzleland are supposed to be familiar in that country of riddles and tricks where all business transactions are done upon a puzzling basis. The school children were returning to their homes when they met the mathematical milkman, who propounds the following problem with which he interests his customers: "In one of these cans there is milk which is so rich with cream that it becomes absolutely necessary to dilute it with a little water to make it wholesome. Therefore in the other can there is some pure spring water; now I proceed to pour from can No. 1 into No. 2 sufficient to double its contents, and then repour from No. 2 into No. 1 enough of the mixture to double the contents. Then, to equalize matters, I again pour from No. 1 into No. 2 to double the contents of No. 2, and find the same number of gallons in each can, although there is one more gallon of water in can No. 2 than there is milk, so I want you to tell me how much more water than milk is there in can No. 1?"

"That is a simple problem," exclaimed Harry, "but if you want a

real clever little puzzle in proportion to work off on your patrons, just solve this: "Suppose you had ten gallons of milk in one can and ten gallons of water in the other and you should pour a quart of milk from the first can into the water can. The mixture would evidently be 40 to 1, but as that might be too rich for the blood of some of your patrons and you want each can to hold ten gallons, you proceed to pour one quart of the mixture back into the milk can. Now tell me; how much greater is the proportion of water to milk in one can than of milk to water in the other?" There is a study in proportion for you!

Here is "another story about his brother":

It was the daily practice of a conscientious milkman to fill his two sixteen gallon cans with pure milk and start out to serve customers on four different streets, the same number of quarts being required on each street. After serving the first street he connected with the city water supply and lo, his cans were again filled to the brim. Then he served street number two and again backed up to the fount, which replenished his cans as before. And so he proceeded serving each street and diluting with water until all of his happy customers were served. If forty quarts and one pint of pure milk remained in the cans after all of his customers were attended to how much pure milk must have been delivered on each of the four streets?



IN PUZZLELAND



Tommy Riddles tells us that we need know nothing about checkers or chess to solve these puzzles. King Puzzlepate is trying to place the greatest number of men on a chess board without having three men in line in any possible direction. He has started by placing the first two men correctly; now it is up to you to assist him by adding as many men as possible without getting any three in line.

We are told that the first checkerboard ever constructed, which was made by a man by the name of Siesa, and is still preserved in the British Museum, is made of four pieces, as the one shown in the second puzzle. Now the four pieces of this board can be rearranged together so as to make three different puzzles: A square board of 64 squares, an oblong one of 65, or an odd-shaped one of but 63. It is said that Dr. Slasher won the championship by this marvelous coup of arranging the four pieces so as to reduce the board to 63 squares. See if you are able to do it. There has been so much discussion regarding this paradoxical problem that occasion is taken to say that Mr. Loyd presented it before the first American Chess Congress in 1858.

A Charade.

I am what I was, which is so much the worse,
I'm not what I was, but quite the reverse;
From morning till night I do nothing but fret,
And sigh to be what I never was yet.

A Charade.

My first, a substance hard and bright,
Is useful, morning, noon, and night;
My second, find it where you will,
Is of the same dimension still:
And by my whole, I often try,
Butchers' and grocers' honesty.

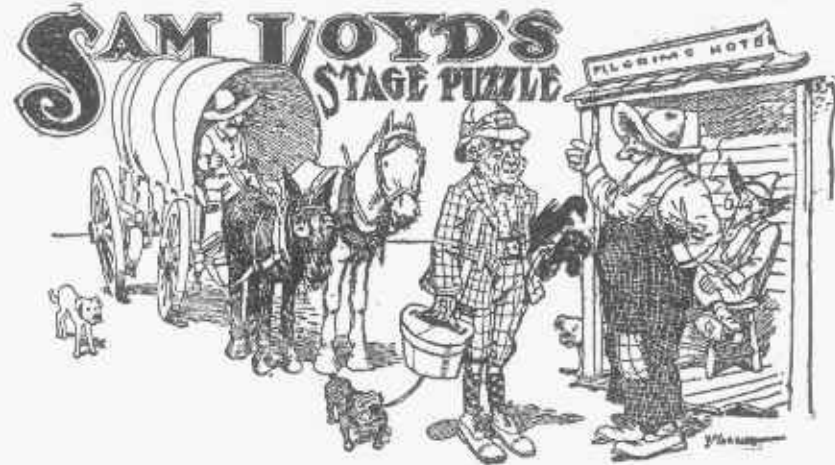

An English tourist in the wild and woolly West was informed that if he wished to walk on to Piketown the stage would only get there one mile ahead of him for although it would get to a certain wayhouse while you were walking four miles, it waits there 30 minutes, so you

would catch up in time to ride on to Piketown if you wished. "But," as the host of the Pilgrim's hotel remarked, "from these facts there is a clever way of figuring out how to beat the stage by 15 minutes!" Can you tell how far it was from the hotel to Piketown?

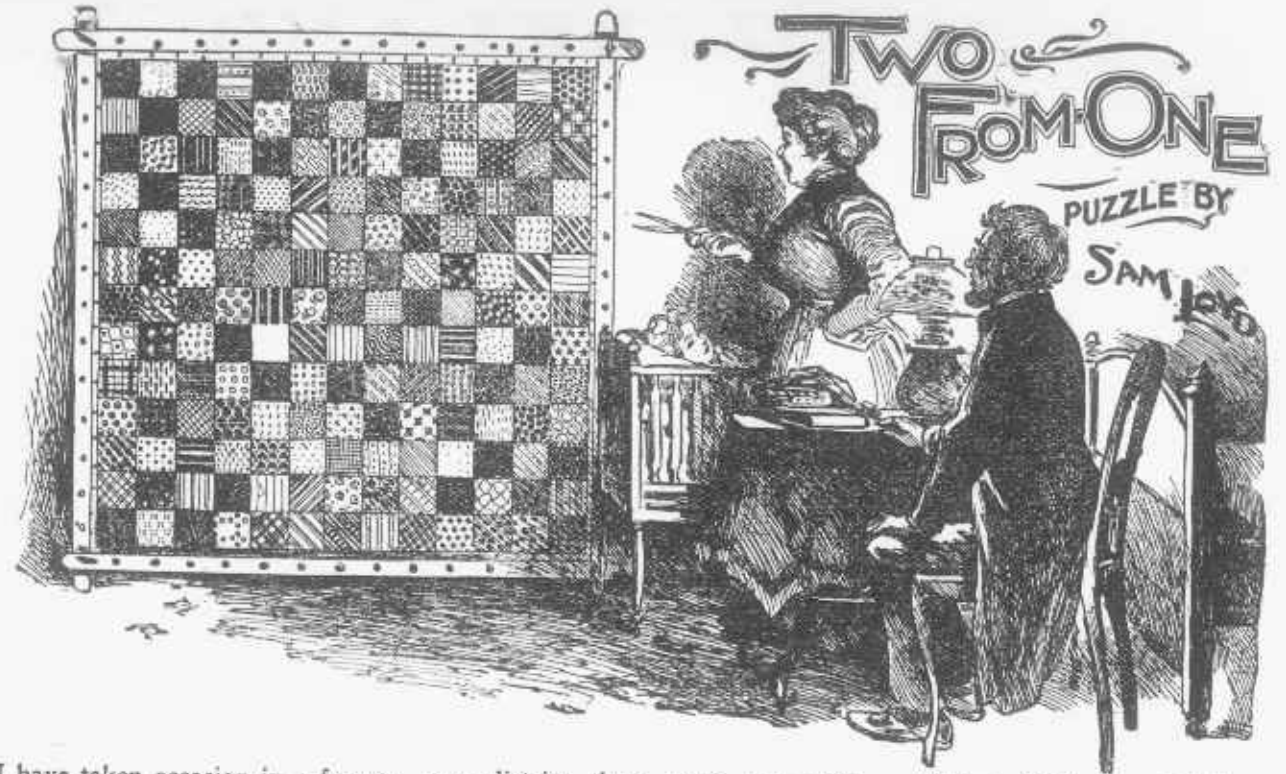

I have taken occasion in a former puzzle to show how eleven ladies, each contributing a square piece, could make a 13x13 patch quilt. Now we will proceed to reverse the problem and show the good parson and his better half confronted by an ordinary problem in household economy. They have use for two quilts now, and as they have but one in stock, so they are compelled to draw upon their inventive resources. The sketch shows them discussing the ways and means of securing two from one to the best advantage. The problem, it may be seen, differs from the Pythagorean rule for uniting or separating squares, in that the checkered pattern prevents the bias cut on the line of the hypotenuse, nevertheless, it is closely allied to square root and the 47 problems of Euclid. Cut the 169 patches into the fewest possible number of pieces which will fit together and form two squares.

Worrying the Query Editor.

"The question, sir," said the chairman of the delegation, "is an important one, but more difficult to answer than you would think, when you first hear it. We have wagered a matter of three cigars on it, so there is a special reason why you should be very careful in answering it."

"Fire away," said the query editor, shortly.

"Well, you see, it's this way," explained the spokesman. "Over in

our district there were two men named John Jinks, and they were father and son. Is that clear?"

"Perfectly. Go ahead."

"Well, last night they were both burned to death in the same house, and to-day, when we were making up a list of those who lost their lives, the boys insisted on putting down 'John Jinks, sen.' and 'John Jinks, junr.'"

"Quite right," asserted the query editor.

"That's what we came to ask you about," returned the spokesman. "Of course, we all knew who was meant, but technically—"

"Technically it was exactly right," interrupted the query editor.

"Sure?"

"Sure! Of course, I'm sure. How else would you refer to them?"

"Oh, if you're so dead sure about it we're not going to dispute you, but you ought to take all the technicalities into consideration."

"I have," thundered the query editor. "If you can advance any reason why they should be referred to in any other way, fire ahead. If you can't, get out and let me go on with my work."

"Well," said the spokesman, slowly and deliberately, "I figured it out a little differently. You see, the old man lived downstairs and the boy lived on the floor above, and the fire started in the basement. Consequently, it stands to reason that the old man died first."

"What of it?" demanded the query editor.

"Why, when the old man died, the young man ceased to be 'junior,' didn't he?"

"Um—ah—"

"And if he did, he was not John Jinks, junr., when he died. Consequently, no John Jinks junr., died at all. That is the way I figured it out, but, of course, a query editor is always right, and if you say that—"

The chairman of the delegation dodged as an inkstand grazed his head and struck the wall, leaving a weird mark which looks like a sign of the black hand.

It may be because I was there and heard the editor's ejaculation, or, that being a puzzlist, such things come easy, or it may be sheer imagination, but when I look at that blotch I can read the editor's last remark just as plain as if it was written in black and white. And I should like to know if it is as clear to other palmists as it is to me.

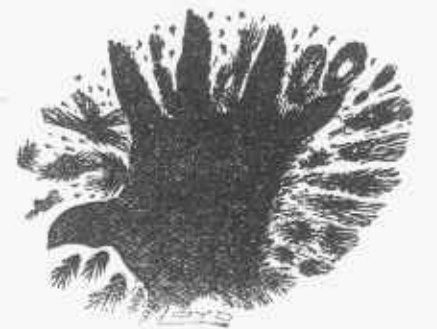



The above little tale, told in eight tableaux, was given some time ago to see who could give the best reading of the same, as well as to originate some clever tales of the same kind.

I will take occasion to say that in my very early youth I developed a faculty for cutting silhouettes, and have had occasion to make likenesses of many of the crowned heads of Europe, as well as of distinguished personages from all parts of the world. I propose at some future day to give some illustrations which became quite noted, but will at present only refer to an amusing incident which befell me at Glasgow, Scotland.

We were discussing the greetings, or salutations, of the different nationalities, and I illustrated the subject with the portraits shown at the foot of the page.

Now let me tell you how the different people say "good-morning."
 "How can you?" That's Swedish.
 "How do you are?" That's Dutch.
 "How do you stand?" That's Italian.
 "Go with God, senior." That's Spanish.
 "How do you live on?" That's Russian.
 "How do you perspire?" That's Egyptian.
 "How do you have yourself?" That's Polish.
 "Thank God, how are you?" That's Arabian.
 "May thy shadow never grow less." That's Persian.
 "How do you carry yourself?" That's French.
 "Be under the guard of God." That's Ottoman.
 "How is your stomach? Have you eaten your rice?" That's Chinese.
 And the most ridiculous of all is American: "How do you do?"

It does not say what you are expected to do, but just simple, How do you do?"
 We were discussing games of skill and chance, when a gentleman from Glasgow said that the Scotch could beat the world at checkers. I accepted the challenge, and played one game with each of the sixteen personages shown below. I lost to the gentleman from Dundee, the one from Dundalk and the one from Dunkirk, but won from all the others.

Now examine the faces carefully, and see if you can pick out the three who beat me!

But speaking about checkers reminds me of another little puzzle connected with the same incident: The discussion of the prowess of the several nationalities resolved itself into a wordy battle which, for lack of a checker board, could not be brought to a practical test, when a solution to the problem was suddenly discovered. A woman was observed in one of the seats wearing a plaid shawl which had been repaired by a remarkable patch!



A shilling was offered to the good woman for the privilege of playing a few games of checkers on this patch, which offer was not only readily accepted, but she cut out and presented us with the piece. But right here comes a most remarkable puzzle. She cut that irregular patch in two pieces, which

fitted together so as to form a perfect eight-by-eight checker board! Can you perform the feat?

To prove that the good woman was endowed with her full quota of brains, I will give another puzzle which she proposed.

Observing that we played only on the black squares, she suggested that two more players might engage in a game on the white squares. When we remarked that it would be somewhat inconvenient, she remarked, "Then I would construct a checker board with only thirty-two squares, so that they would all be used."

This is the puzzle: Construct a thirty-two-square checker board which gives every possible combination of the game as it is now played, but do away with those useless extra thirty-two squares.

Then there was another puzzle which I would call to your attention: One game was played and brought to an absolute finish in just twelve moves! If I am not mistaken, it holds the record for brevity of checker play. Can you produce the game?

MR. OWEN'S VALUATIONS.

I leave it to the ingenuity of our puzzlists to figure out a reasonable reply to the following query from a collector of rare old manuscripts. He is not a man who is accustomed to expressing himself in the ordinary, understandable way that most of us choose. He says:

"Regarding the value of all of my letters shown, I would say that two are worth six dollars, ten are worth ten dollars, while none is worth sixteen dollars, while one being worth eleven dollars, I would like you to estimate the value of a ton upon the same basis!"

"Respectfully,
 "T. OWEN."

WHO WILL GET the NOMINATION?
 By SAM LOYD

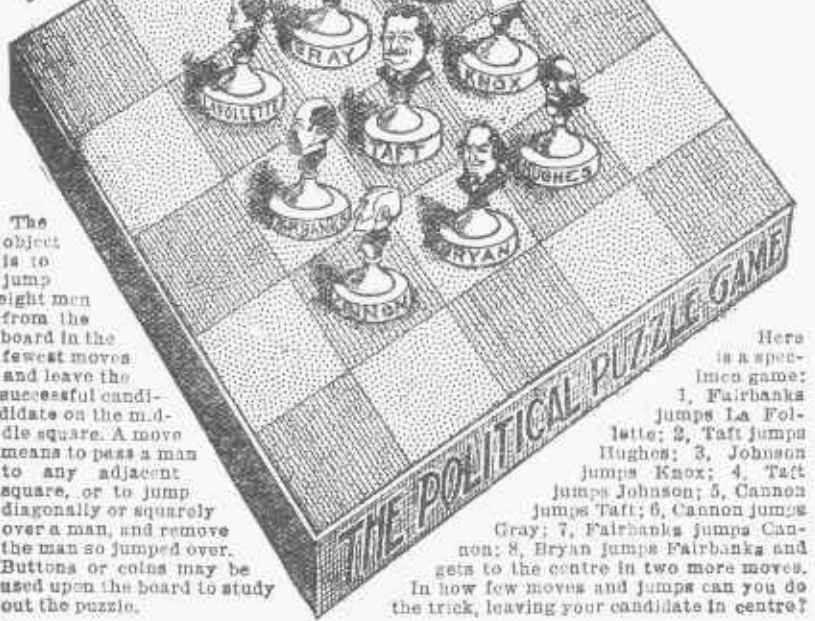

The object is to jump eight men from the board in the fewest moves and leave the successful candidate on the middle square. A move means to pass a man to any adjacent square, or to jump diagonally or squarely over a man, and remove the man so jumped over. Buttons or coins may be used upon the board to study out the puzzle.

Here is a specimen game:
 1. Fairbanks jumps La Follette; 2. Taft jumps Hughes; 3. Johnson jumps Knox; 4. Taft jumps Johnson; 5. Cannon jumps Taft; 6. Cannon jumps Gray; 7. Fairbanks jumps Cannon; 8. Bryan jumps Fairbanks and gets to the centre in two more moves. In how few moves and jumps can you do the trick, leaving your candidate in centre?

During every Presidential election I have issued puzzles for campaign purposes, large quantities of which have scattered all over the country. The above is a souvenir of 1908, which created somewhat of a furor. Then, after the nominations were made, I gave the Presidential Puzzle which shows the candidate going through the forty-nine states and territories on a stumping tour. The puzzle is to start from any point selected and pass through all the numbers and back to the place of the beginning in the fewest number of straight strokes. The route marked on the map shows how to perform the feat in 14 trips, but it can be done in fewer, and will prove to be a remarkably clever and difficult puzzle.



HANNAH

Here is an odd little puzzle in the form of a monogram, as shown, we also discover that we may begin and end at any point, and from that fact of each monogram being susceptible of being read upside down, as well as backwards, the puzzle becomes very confusing to determine just how many ways it can be read so that no two ways will be exactly alike, the only stipulation being that the letters must be adjacent, so that one is not permitted to slip across the diagram.

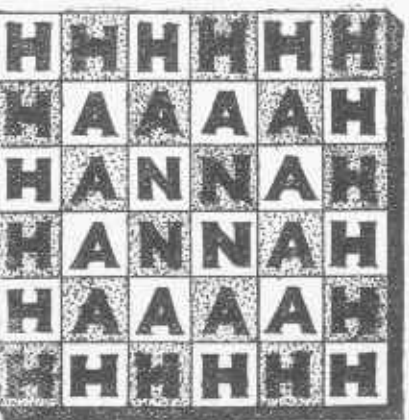

- Here is a similar puzzle:
1. Behead a girl's name and leave a boy's name.
 2. Behead a kind of gum and leave a girl's name.
 3. Behead a garment and leave an insect.
 4. Behead a piece of wood and leave part of the body.
 5. Behead what all wish to have and leave what we can't live without.
 6. Behead a farming tool and leave a small house.
 7. Behead a garment and leave a mass of stone.
 8. Behead an instrument to show time and leave part of a gun.
 9. Behead a weaver's quill and leave a collection of water.
 10. Behead what many like to do and leave a girl's name.
 11. Behead one of the months and leave part of a circle.
 12. Behead a port, or haven, and leave a bower.
 13. Behead an animal and leave part of the head.
 14. Behead a part of a chaise and leave part of the foot.
 15. Behead a ship instrument and leave a kind of tree.
 16. Behead a place for a fire and leave what we live on.
 17. Behead a kind of stone and leave a number.
 18. Behead a building and leave a vine.
 19. Behead the cry of a dog and leave a bird.
 20. Behead a plant and leave a reptile.
 21. Behead a carpenter's tool and leave a road.
 22. Behead a part of a whip and leave a kind of tree.
 23. Behead a man's name and leave a vessel.
 24. Behead a building and leave a household article.
 25. Behead a piece of leather and leave a snare.

BURIED PROVERB.
 In each of the following sentences a word is concealed. When the words are guessed, and read in the order here given, they will form a familiar proverb.
 1. A naughty cat ran away. 2. They found a closely written roll in gathering up the rubbish. 3. It is the best one that I have ever seen. 4. The rug at her stairway is not a valuable one. 5. He is an old acquaintance of mine. 6. Amos soon saw through the strategem.



In PUZZLELAND



The first of the Puzzleland problems is to divide that triangular flag into four pieces which will fit together as to form a perfect square. In the second tableau the Sultan of Zulu is explaining Jungle Arithmetic to Princess Enigma: a Monkey, Crocodile, and an Elephant are worth a hat. The values of the Monkey, Crocodile, and Elephant multiplied together also equal a hat; and as the value of monkeys and crocodiles are the same, who can guess what the Sultan of Zulu paid for his silk hat?

A STUDY IN COMIC GEOGRAPHY.

Try the following questions some night when you have a party of friends assembled. Also see if you can send me a correct list of answers:

1. What country is always lamenting?
2. What is a good country to get angry in?
3. What country in the south temperate zone is never warm?
4. What country is always in a state of famine?
5. What is a good country for fishing rods?
6. What country is good for fish?
7. What island is like a foolish girl?
8. What country is best for ivory?
9. In what land is the traveler in danger of being gobbled up?
10. What is the best country to bore oil wells in?
11. What is the best country to get shaved in?
12. When is an African traveler almost out of money?
13. Why does a certain city in Ireland increase in size very rapidly?
14. To what city should we go to purchase paper at wholesale?
15. What city in France is a bad ending for a journey?
16. What city in Europe is always in a state of conflagration?
17. Here is an old coin with the name of the place where it was found, concealed in the description.

Why are men like pipes? A.—Because the best of them are mere shams.
Why are young ladies bad grammarians? A.—Because so few can decline matrimony.

What is a soldier's definition of a kiss? A.—A report at headquarters.
What is that which increases the more you take from it? A.—A hole.

A NUMISMATICAL PUZZLE.



From whence came the classical-cut tails?



Prof. Embry has discovered that the Sun spots may be fitted together so as to show a perfect sphere, supposed to represent a shattered planet. It is quite a difficult puzzle, however, to fit them together properly.

A BOTANICAL TREE-TICE.

Here is a botanical potpourri of trees, shrubs, vines, etc., given to test the reader's knowledge of such matters. No one is expected to give the entire list correctly, so do not hesitate to present the names of such as you may hit upon, as it is safe to say it will prove to be an interesting guessing contest.

1. What is the sociable tree?
2. And the dancing tree?
3. And the tree which is nearest the sea?
4. And the busiest tree?
5. The most yielding tree?
6. And the tree where ships may be?
7. The languishing tree?
8. The least selfish tree?
9. And the tree that bears a curse?
10. The chronologist tree?
11. The fisherman's tree?
12. And the tree like an Irish nurse?
13. What's the traitor's tree?
14. And the telltale tree?
15. And the tree that is warmest clad?
16. The layman's tree?
17. The housewife's tree?

28. And the tree that never stands still?
29. And the tree that got up?
30. And the tree that was lazy?
31. And the tree neither up nor down hill?
32. The tree to be kissed?
33. And the dandiest tree?
34. And what guides the ships to go forth?
35. The unhealthiest tree?
36. And the tree of the people?
37. And the tree whose wood faces the north?
38. The emulous tree?
39. The industrious tree?
40. And the tree that warms mutton when cold?
41. The reddish-brown tree?
42. The reddish-blue tree?

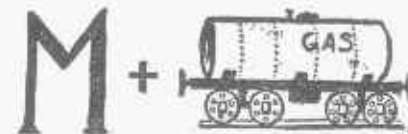

18. And the tree that makes one sad?
19. What's the tree that in death will benight you?
20. And the tree that your wants will supply?
21. And the tree that to travel invites you?
22. And the tree that forbids you to die?
23. What tree do the hunters resort to the skies?
24. What brightens your house, and your mansion sustains?
25. What tree urged the Grecians in vengeance to rise? And fight for the victims by tyranny slain?
26. The tree that will fight?
27. And the tree that obeys you?

Charley Smallcash treats his best girl to a trolley ride, but on account of his limited resources they plan to walk back, so, if the car goes at the rate of nine miles an hour and they can walk at the rate of three miles an hour, how far could they ride if they must be back in eight hours?

SAM LOYD'S



**SOLILOQUY OF A PRECO-
CIOUS LITTLE CHICKEN
DISCONTENTED WITH
ITS HOME.**

"Here's what's going to fly the
coop
Boss the yard and make things
whoop!
I won't be sat on by a hen,
I want to roost up with the men,
Flap and crow as father uster,
Fight and strut like full-fledged
rooster,
Join the union agitators,
Smash and boycott incubators!
Now mama halves her legal thirds
Of papa's worms to feed us birds,
But what's the chance of grub for
me

(Although as smart as any three)
With fifteen others in the brood,
In one long scramble after food?"

That's the mathematical problem
in an egg shell: what are the chances
for that little broiler to catch
an early worm? But there is another
puzzle connected with the picture
which has a bearing on Confucius'
great proposition. Did the original
chicken come from the egg or did
the first egg come from the chicken?
How would you cut this little chicken
in two pieces which can be fitted
together so as to form a perfect
egg?

Here is a sketch of the poet who wrote the
above lines on the precocious chicken: The
picture was drawn by "Sammy" when he
was eight years old.

Why are pianos noble characters? A.—
Because they are grand, upright and
square.

Why is an actress like an angel? A.—
Because we seldom see one that is not
painted.



INJURED INNOCENCE.
"I haven't seen 'em. Do I look like a
chicken thief?"

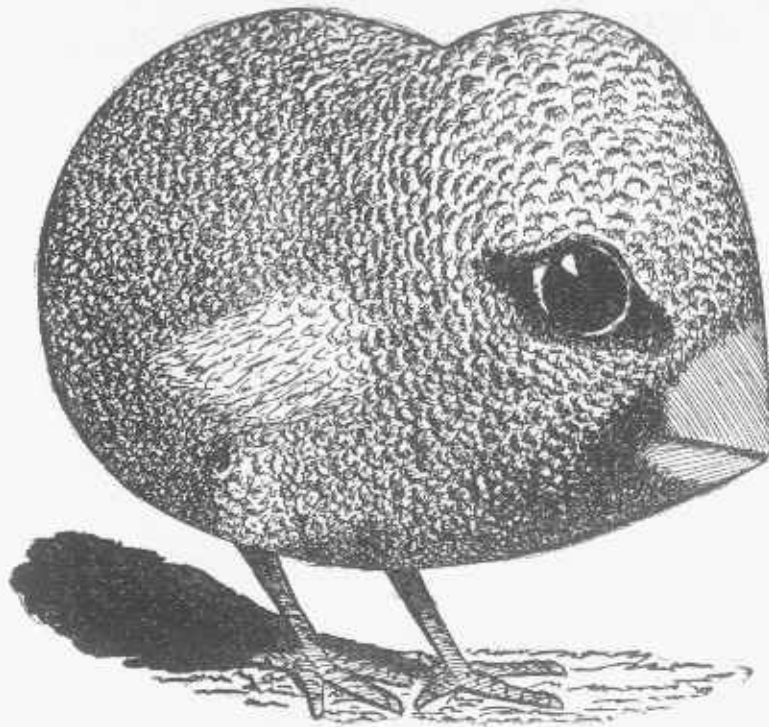

**AN ANCIENT REBUS BY
FRANKLIN.**

Here is an old time rebus by
Poor Richard, which might well be
termed "a blunderbuss." It says,



"All that glitters is not gold,"
which is far from the truth, for
gold does glitter. It should have
said: "All is not gold that glitters,
"for tinsel, brass and other things
glitter but are not gold. It is on a
par with the ungrammatical notice
posted in our subways:

NO SMOKING ALLOWED.

On the invitation cards to a public
dinner, where it was hoped that
the gentleman would appear in full
evening dress, was added "undress
suits allowed." The intimation being
that full dress were preferred,
but that undress suits would be per-
mitted. It is plain, therefore, that
smoking in our subways is pre-
ferred, but no smoking will be al-

lowed, or it would have stated
plainly. "Smoking not allowed."
A very pretty puzzle may be built
upon this NO SMOKING AL-
LOWED sign. How many words
can you read in regular sequence
by merely omitting other letters?
I see nose, King, all, old, and many
other words, but how many are
there all together?

PERFECT NUMBERS.

Do you know a perfect number
when you see one? Any number
which is exactly the sum of all of
its integral divisors is called "per-
fect." There are a good many per-
fect numbers—6 is one, 28 is an-
other. Thus 3, 2 and 1 are the only
numbers that divide exactly into 6,
and together they add up to 6. So
with 28; its divisors are 14, 7, 4,
2, 1, their sum being 28. Do you
know any other perfect numbers?

AN AMUSING CATCH.

FitzSmart—"Would you say a
yoke of oxen is plowing or are
plowing?"

FitzNoodle—"Is, of course."

FitzSmart—"Would you say
the yolk of an egg is white or are
white?"

FitzNoodle—"Is, of course.
What next?"

FitzSmart—"Well, I should say
the yolk of an egg is yellow."

**The Crazy Clock of
Zurich**
BY
SAM LOYD

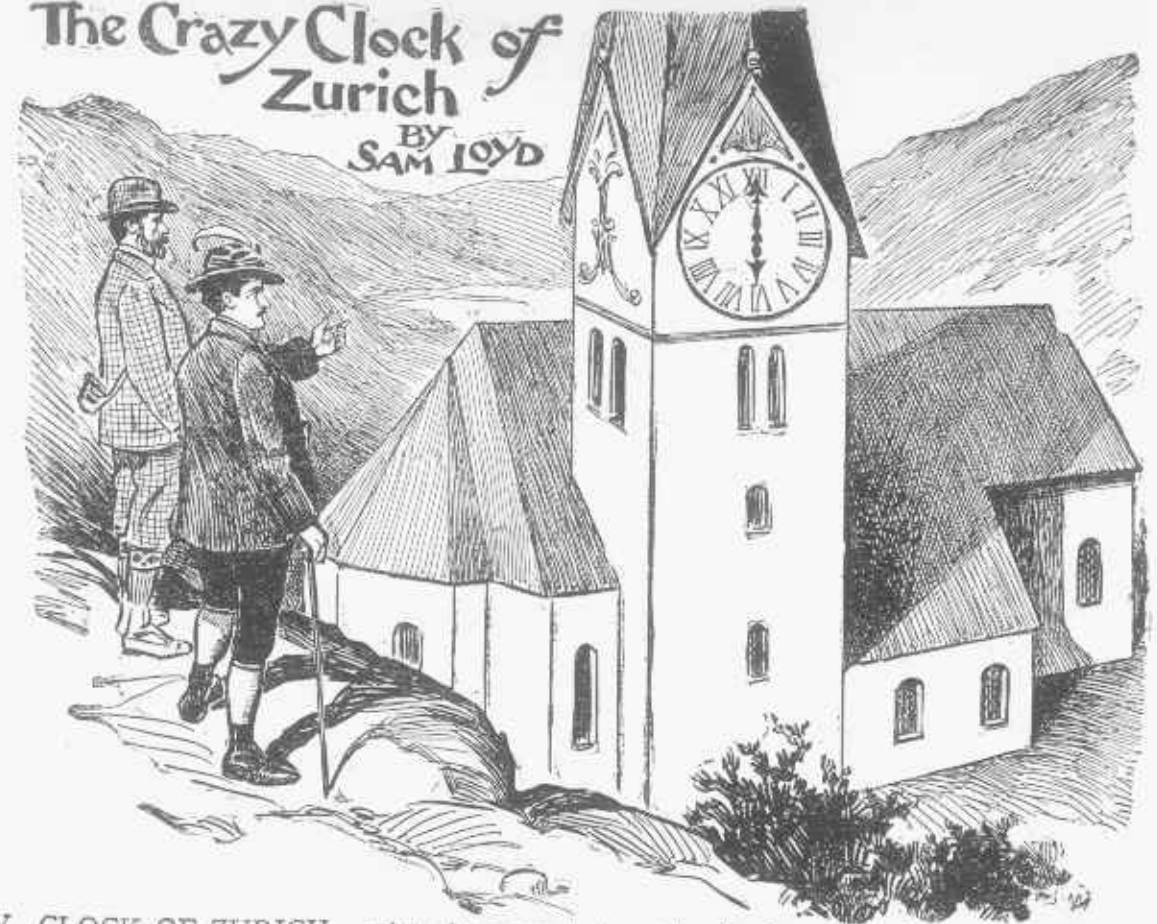

CRAZY CLOCK OF ZURICH.

Swiss tourists will recognize in
the accompanying sketch a deserted
church in a lonely spot near the
outskirts of Zurich, and have doubt-
less been told the weird story of its
bewitched clock. Omitting the su-
pernatural and mysterious features
of the story of which the tourist
is regaled with many versions, it
may be briefly stated that the
church was built somewhere about
the middle of the fifteenth century
and was furnished with a clock by
the oldest citizen of the place, a
man named Jorgensen, who was re-
puted to be the founder of the man-
ufacture of clocks, for which the
place has become noted. The clock
was started at 6 o'clock in the
morning, accompanied by the dis-
play of ceremony with which any
event of the slightest importance is
always inaugurated by the Swiss.
By what I look upon as a mere me-
chanical accident, the hands of the
clock must have been put upon the
wrong pinions, so that the hour
hand started off while the latter re-
volved twelve times slower, with,

what the peasants term the dignity
of the hour hand. The old clock-
maker was infirm, and the strange
antics of the bewitched timepiece
explained to him, he insisted on be-
ing carried in his bed to witness the
strange phenomenon, but when he
arrived the time as indicated upon
the clock was perfectly correct,
which had such an effect upon the
old man that he actually died of
joy. The clock, however, continued
its strange antics and was looked
upon as bewitched, and no one was
ever bold enough to repair or even
wind it, so its works have rusted
to pieces, and all that remains is the
curious problem which I now pro-
pose:

If the clock was started at 6
o'clock, as shown by the picture,
with the hour hand moving twelve
times as fast as the other, as ex-
plained, when will the hands first
reach a point which will indicate
the correct time?

A LEGAL QUESTION.

In a Washington store window
there is displayed a freak United
States piece of money which has

caused no end of discussion. It is
a bill which, through some error of
the pressman, is a self-evident mis-
print; on one side it has the per-
fectly printed and numbered face
of a twenty-dollar bill, while on
the other side is the equally per-
fect impression of a ten-dollar
bill. The question of what it is
worth or might be sold for is not
under discussion, for Buffalo Bill
offered, and is still willing to give
fifteen hundred dollars for it, but
you are asked to give an opinion
as to the responsibility of Uncle
Sam if he was asked to redeem
that particular note. Legally or
morally, how much should the gov-
ernment pay for it?



SOME GOOD ADVICE
by the Bishop of Oxford:

THE POSTMAN'S PUZZLE

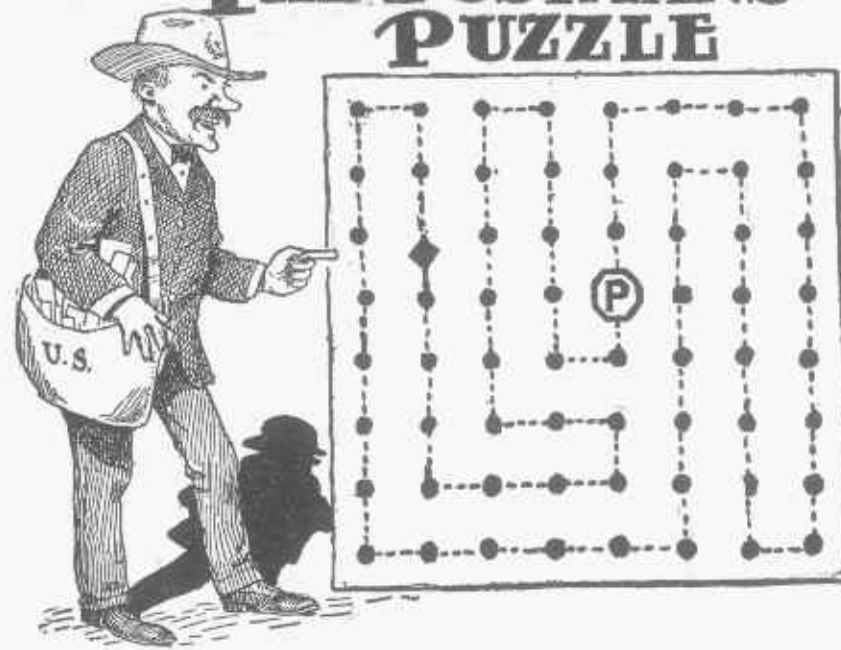

Peter the postman has to collect the mail from sixty-three letter-boxes; his predecessor went over the route from one lamp-post to another and back to the post-office near the center in nineteen turns. Peter has found a much better route calling for a fewer number of turns, and challenges you to discover it. Just mark a new route in the fewest possible number of moves going from the post-office to each lamp-post and back to the starting point. Peter is calling attention to the fact that the square lamp-post is a little out of alignment.

A Rebus

Though my first may be scorned by your lovers of state,
Yet my second with hundreds has fashion and weight.
For my whole, you may find it on going to bed,
Either under your pillow or over your head.

Cipher Answer.—3, 15, 20, 20, 15, 14.

A Charade.

A vowel with two beasts unite,
You'll have what poets often write.

There are two equally good answers to this charade, 5, 16, 9, 7, 18, 1, 13, or 1, 14, 1, 7, 18, 1, 13.

A Charade

Ladies, a riddle I submit:
To fifty now add one;
And, having thereby shown your wit,
You may my whole put on.
Cipher Answer.—12, 1, 3, 5.

A Rebus

My whole takes a lofty position,
And yet may be reckoned obscure.
Behold, then whate'er its condition,
It cannot be silent, I'm sure.
Cipher Answer.—3, 12, 15, 21, 4.

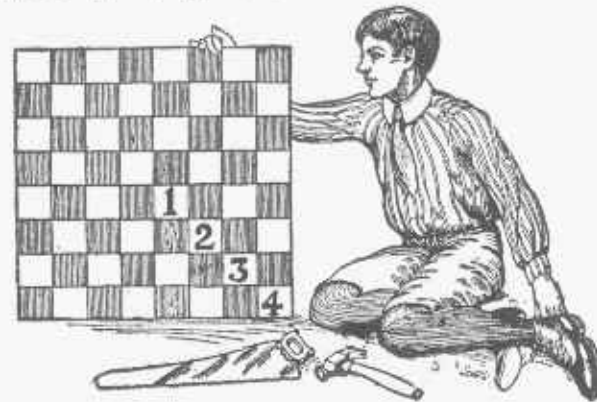

Here is a pretty checkerboard puzzle which calls for much ingenuity and patience. It appears that a boy received a present of a checkerboard which had been divided into four pieces. All of these pieces were exactly the same shape and size. They were numbered respectively 1, 2, 3

and 4. He fitted the pieces together, making the complete board with the numbers placed as seen in the illustration. The puzzle, therefore, is to reverse the plan of the boy's working and to divide the board into four pieces, all the pieces exactly alike, each section bearing one of the numbers, 1, 2, 3 and 4.

A Rebus

My first is a curious thing,
Of Nature's own produce,
And many who have lost a limb
Have found it of great use.

By my second's wondrous skill
Ships are made with ease
To stem against both wind and tide
Across the boundless seas.

My whole is very often found
Together with my first,
And comes in very handy
When you would quench your thirst.
Cipher Answer.—3, 15, 18, 11, 19, 3, 18, 5, 25.

A Rebus

My first is a number, my second another,
And each, I assure you, will rhyme with the other;
My first, you will find, is one-fifth of my second,
And truly my whole a long period reckoned;
Yet my first and my second (may think not I cozen),
When added together will make but two dozen.

Cipher Answer.—6, 15, 21, 18, 19, 3, 15, 18, 5.

When is a dog hurt like one of Dickens' characters? When it is all of a twist (Oliver Twist).

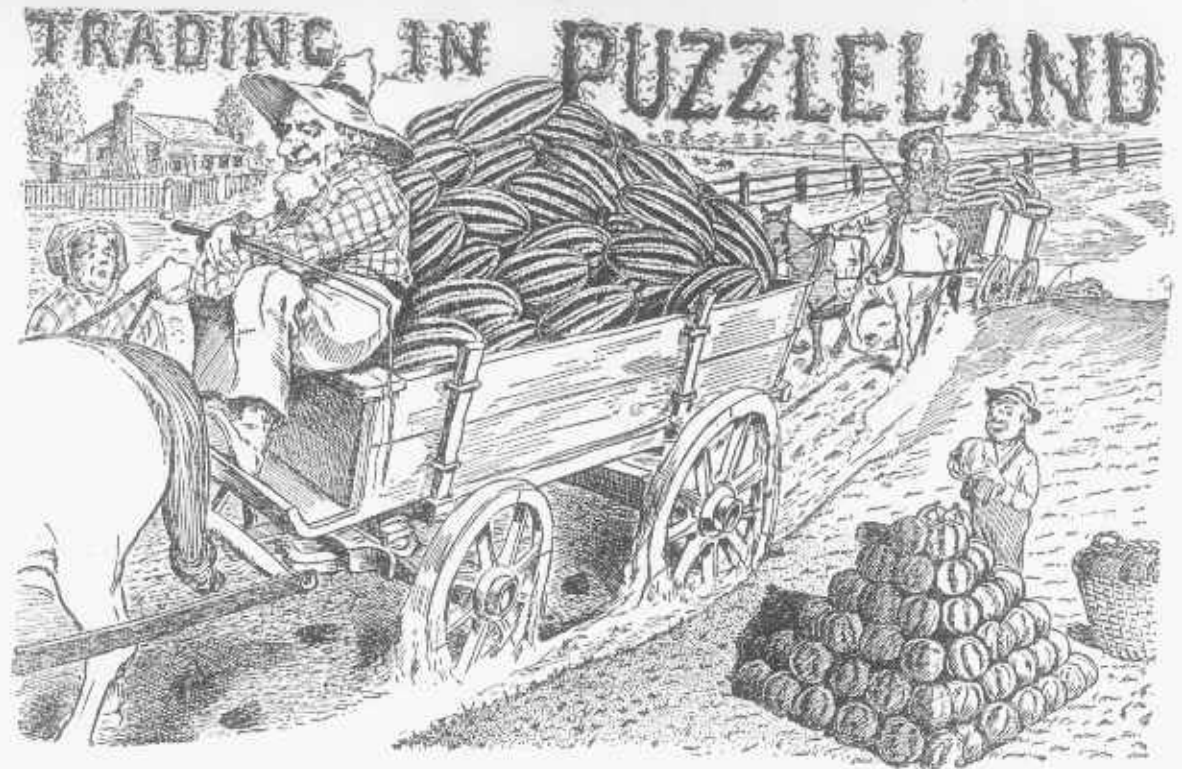

We are here given an insight into the business methods of Puzzleland, where every transaction is based upon a problem or trick which enables the clever ones to get the best of a bargain. Farmer Jones tells how he proceeded to sell the half of his melons and half of a melon to the first customer he met with. The second purchaser took one-third of the remainder and one-third of a melon. The next customer purchased one-quarter of what remained and one-quarter of a melon. Then he sold one-fifth of those left and a fifth of a melon. What was sold were disposed of at the rate of \$1 a dozen, but he then cleared out the remainder at the rate of thirteen for a dollar, and asks you to guess how much money he got for his stock of melons?

Little Tommy Riddles, who is shown recreating on a farm, also has his troubles and asks such puzzlists as are familiar with the problems of piling cannon balls, to tell him what two triangular pyramids of musk melons could be combined so as to make one large triangular pyramid? He has two pyramids of melons which he desires to combine in one larger pile.

A Charade.

My first is an useful animal, my second is a root, and my whole is a root.

A Charade.

My first is unaffected seen,
My next a ponderous weight will show;
My whole appears with vacant mien,
Almost an idiot you'll allow.

A Charade.

My first secures and guards my second,
Which is a sort of profit reckon'd,
And from my total doth proceed,
As is by ev'ry trade agreed.

SUBSTITUTION PUZZLE



Substitution Puzzle.

By the slip of his pen the artist has introduced a very confusing species of monkey. Can you change it by substituting one letter so as to tell what they are?

IN PUZZLELAND

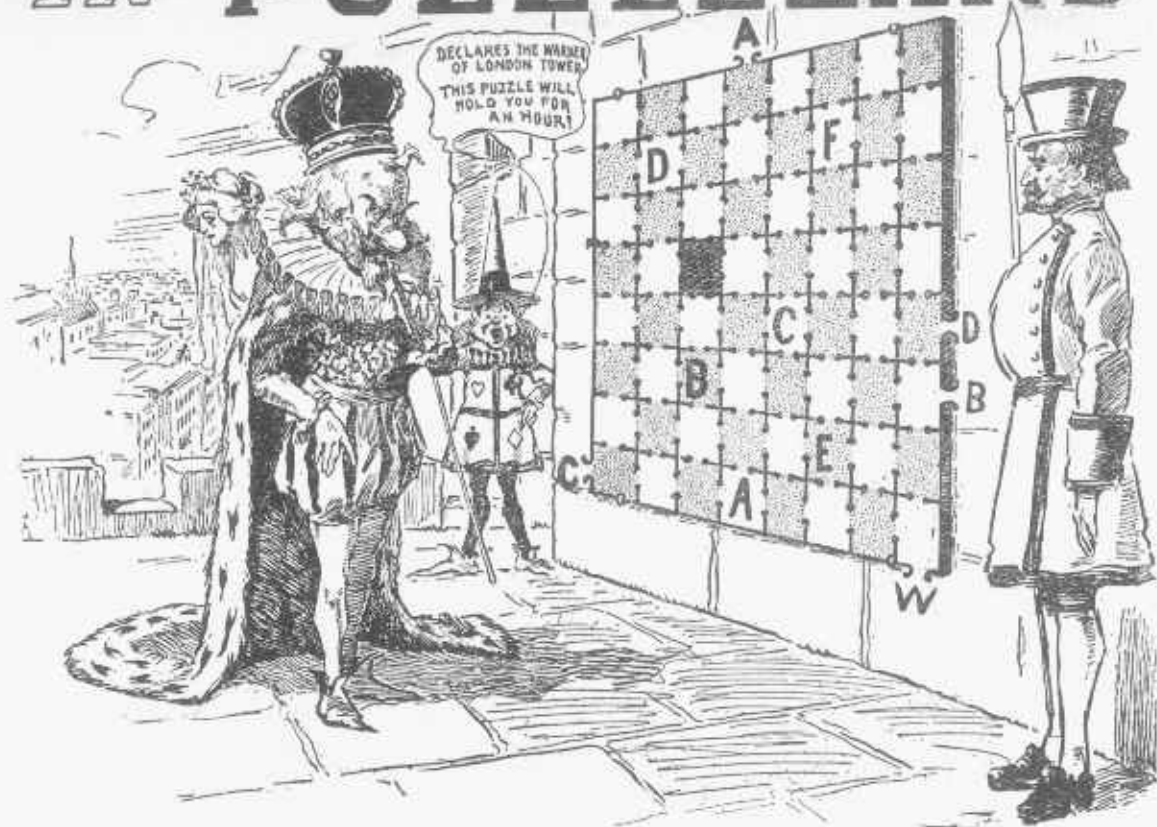

Tommy Riddles here presents two exceptionally good puzzles which he predicts will hold our clever solvers for an hour. King Puzzlepate is pondering over the famous problem of London Tower, which is as follows: Five guards are shown on the plan of the tower by letters, and promptly at the firing of a gun which denotes the setting of the sun the guard A marches out by the exit A, B exits at B, C at C, D at D, while E changes to F. The puzzling feature of the movements mentioned is to discover how the five marches of the guards can be made without any one man crossing the line of march of another, and yet Tommy says it is a very simple trick when you know how.

That, however, is not so unique a puzzle as a second one, wherein we are told that the warder, commonly known in England as "The Beef Eater," every night, at the witching hour of 12, enters the portal W, and with stately tread marches through every one of the 64 rooms, ending at the dark chamber, where the young princes of Edward IV were supposed to be murdered. By long practice he has discovered the shortest possible way to reach that chamber of horrors, so every one is challenged to discover the route which makes the fewest possible

turns without going through any room twice!

A Charade.

Most attentive's my first to all tales that are told,
And as Moses relates, was with Adam of old;



OF THE CHESS-PLAYING COLONEL.

During my visit to St. Petersburg I met Tschigorinsky, the Russian chess expert, who told me that at the outbreak of the Russo-Jap unpleasantness he was put in command of an army station where 28 regiments were continually in process of formation, 100 men per week being added to each regiment, so that on the last day of every week the one having the most men would be sent to the front.

It so happened at a time when the first regiment had 1,000 men, the second 950, the third 900, and so on

In my second, each year many thousands are laid;
How transient, alas! in all earthly parade!
Let a man in his life-time be ever so droll,
He'll never once jest when he's laid in my whole.

down, decreasing 50 each step to the twentieth, which had but 50, that Gen. Tschigorinsky found that the colonel of the fifth (which had 800 men) was a capital chess player, so, in order to keep him from being advanced to the front, which would occur in five weeks, he allotted him but 30 men every week instead of 100 as given to the others.

Assuming that 20 regiments are being continually recruited, can you tell just how many weeks it was before our chess-playing colonel had to go to the seat of war.

In PUZZLELAND



Little Tommy Riddles calls attention to a couple of Christopher Columbus' famous egg tricks. In the first puzzle the famous trick-chicken, Americus Vespuccius, after whom our great country was named, showed a clever puzzle wherein you are asked to lay nine eggs so as to form the greatest possible number of rows of three-in-line. King Puzzlepate has only succeeded in getting eight rows, as shown in the picture, but Tommy says a smart chicken can do better than that! The funny old King is now trying to work out a second puzzle, which is to draw a continuous line through the center of all of the eggs so as to mark them off in the fewest number of strokes. King Puzzlepate performs the feat in six strokes, but from Tommy's expression we take it to be a very stupid answer, so we expect our clever puzzlists to do better; it is a very ingenious trick, fully as good if not better than that of making an egg stand up on end, for the perpetration of which with an over ripe egg the great navigator was loaded with chains.

A Charade.

My first is a liquor, my second contains it, and my whole is an ancient musical instrument.

A Charade.

When thro' the meadows Sally strays,
My first with sportive zephyrs plays;
One-half a mountain's ancient name,
Where dark combustion bursts in flame,
Will name my next: on Sally's breast,
My glittering whole does often rest.

A Charade.

When sable night rides down the west,
Chased by my first array;
My second comes then with the first,
And hails the genial ray.
My whole combined, to you will show
A time allowed for rest;
Tho' tis absurd, alas! too true,
Good Christians all confess.



Madame Bonpain, of Rue St. Germain, purchased wines from a merchant, who offered a 5 per cent discount. Her butler, however, informed the merchant that he must receive a 5 per cent commission on madame's bills or the goods would prove unsatisfactory. As the honest

merchant only made a profit of 5 per cent on cost he judiciously raised the amount of the bill, which would have been only 882 francs had the butler not butted in, so that they all got their 5 per cent!
What was the amount of the new bill?

THE MOONSHINERS OF PUZZLELAND

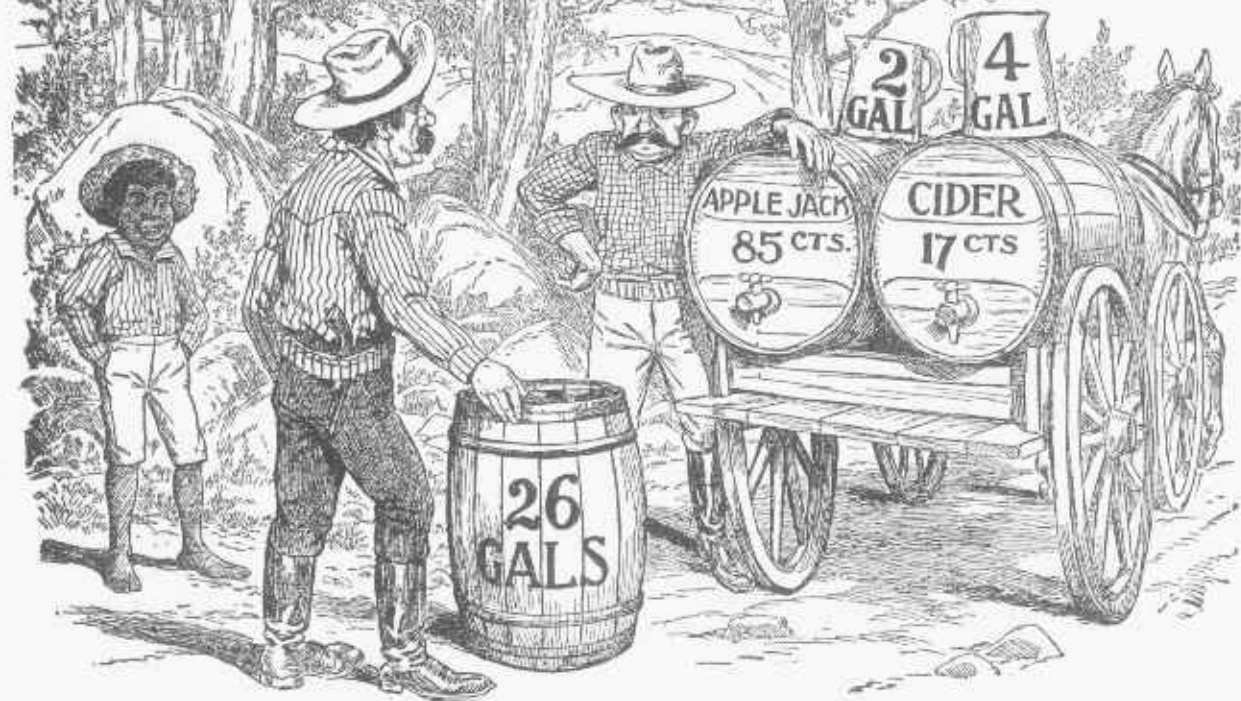

Here is a puzzle which shows that even the moonshiners who manufacture "Mountain Dew" in the wilds of Puzzleland carry on their illicit trade with some kind of a clever trick concealed in every transaction.

Of course, we have all heard of the man with the barrel of honey, who met a customer with a 3 and a 5-quart pitcher, who wanted to purchase 4 quarts of honey. It is a simple matter to juggle the honey around with the two measures until we get the required 4 quarts, but just exercise the gray matter of your brain by trying to solve the puzzle mentally, so as to tell in how few changes the feat can be performed.

That well known feat will prepare your mind for our present juggling puzzle, which is to guess how near that moonshiner, with a barrel of applejack and a barrel of cider (31½ gallons to a barrel) can come to giving his customer \$21.06 worth of "Mountain Dew" as they term mixed applejack and cider, in that 26-gallon keg, if he has only the 2 and 4-gallon measures to juggle with?

You will observe that cider is worth but 17 cents a gallon, while applejack costs five times as much. The puzzle is really to discover how few manipulations are required to perform the feat.

The Puzzle of Trading Chickens.

A farmer and his good wife have been to market trading poultry for live stock, upon the basis of eighty-five chickens for a horse and a cow. "Five times the price of a horse being equal to twelve times the cost of a cow" is the old trading rule of valuations, so, when the good wife said: "John, let us take as many more horses as we already have selected, and we will have but seventeen head of both to feed through the winter."

"I think cows pay the best," re-

plied the farmer, "and, moreover, I find that if we double the number of cows we have picked out it would make nineteen animals in all, and we would just have chickens enough to pay for them."

These unsophisticated country people knew nothing about algebra or mathematics, and yet they knew to a feather just how many chickens they had and the number of horses and cows they were to get, which are the questions for our clever puzzlists to answer.



Once a Puzzlist, Always a Puzzlist.

To point a moral and adorn a tale I will take occasion to explain to such as have been struck by the innate modesty of the puzzle editor that when he became of age his grandmother presented him with a watch. In her early days, which would now date back about a century and a half, she was very partial to puzzles, and used to contribute to the local papers under the nom de plume of Kitty Sharp. Well, in accordance with the time-honored motto of our craft, which says "once a puzzlist always a puzzlist," the ruling passion was still strong, for she presented the time-piece, accompanied by her admonition that "the watch will always teach you to be modest." As it must have exerted a powerful influence on my whole life, as intimated, I pass the precept along for the rising generation: "why should a watch teach you to be modest?"

Then she gave me an illustrated rebus by Davy Crockett and one by Benjamin Franklin, both of whom were fond of puzzles as school children. Just think of it! Without doubt, George Washington has puzzled over these rebuses, for they were exceedingly popular in those days.

Two Old Style Rebuses.



There is a reasonable problem which comes with the whist craze, and which will interest all alike, whether they play the game or not. It is a simple arrangement of a party of players and five tables and makes as pretty a puzzle as the young folks could wish to study over. It occurred at a recent whist party, where five married couples were pitted against five pairs of young folks.

	Tommy.	
Mr. Smith.	Table No. 1.	Mrs. Smith.
	Nellie.	
	Harry.	
Mr. Jones.	Table No. 2.	Mrs. Jones.
	Dolly.	
	George.	
Mr. Brown.	Table No. 3.	Mrs. Brown.
	Minnie.	
	Peter.	
Mr. Clark.	Table No. 4.	Mrs. Clark.
	Kitty.	
	Charley.	
Mr. White.	Table No. 5.	Mrs. White.
	Bertie.	

Showing how the players were seated five times.

Mr. and Mrs. Smith, for instance, are always partners and play one game at each of the five tables. Tom and Nell are also partners, and are to play one game with each of the married couples, and so on; no one to play twice at the same table nor to meet the same opponents a second time.

This is a very popular plan with whistites, to test the relative strength of their teams. It is a simple matter to make four changes with sixteen players, or five with twenty as given in this puzzle, or seven with twenty-eight players, "but for the life of me," as a noted whist crank says, "I don't see how to make the changes on six tables, for twenty-four players."



PROPOSITION—Tell how much they drank and how to divide the remainder into three equal portions.

HERE IS A JUGGLING trick, which occurred to a company of our boys in blue during the campaign in Cuba.

It is merely an extension of the famous old story of the barrel of honey and a five and a three-gallon measure, into which you are to put four gallons of honey.

In this instance, the boys, who had been on a foraging expedition, captured, among other things, a ten-gallon keg of beer. They naturally sampled a part of it, and carried the remainder back to camp in three equal portions, viz., one portion in the keg and the other two portions in the three and five-gallon measures.

The puzzle is to show how much they drank, and how they measured out and divided the balance into three equal parts, without resorting to any other expedients except straight measuring, as is understood to govern juggling problems of this nature.

Question of Facts and Figures.

An authority on life insurance matters says: "It is incorrect to assume that reliable calculations cannot be made upon the probability of the length of life, for we know that even the health of the different cities has been figured down to an exact chance or prob-

ability, as can be demonstrated by the infallible laws of mathematics."

The distinguished actuary has fallen into the popular error of placing implicit confidence in the all-conquering power of figures, for noting that while it is true that "figures never lie," nevertheless, some liars will figure, and do not realize that there are many calculations pertaining to the principles of life insurance which will not yield to mathematics. No more unfortunate illustration could have been referred to than the health rate of cities; for the death rate in proportion to the population of a town has nothing whatever to do with the health of the place. If a certain locality were so healthy that no one died for fifty years, a new disease called old age must eventually develop and become so virulent as to produce a higher death rate. The only correct method of determining the health of a town or of a class of people must be based upon the average age of those who die.

Speaking about the infallibility of mathematics, my friend the actuary is challenged to figure out the value of my offer if I say: You may toss a cent and as soon as it falls head I will give you a prize. If it falls head on the first throw I will give you \$100, but it does not fall head until the second throw, I will pay \$200, or \$400 if head first

appears on the third fall, or \$800 on the fourth throw, or \$1,600 on the fifth, always doubling the prize until the head first appears.

It looks like a simple proposition, but no one can give even an approximate value of the offer as originally made.

What affection do landlords most appreciate? Parental (pay-rental).

When day breaks, what becomes of the pieces? They go into mourning (morning).

Why are washerwomen the silliest of women? Because they put out their tubs to catch soft water when it rains hard.

Why is a book like a king? Because it has many pages.

When are two apples alike? When pared.

When a colored waiter drops a platter of roast turkey, why does it create a great continental disaster? Because it is the fall of Turkey, the overthrow of Greece, the ruin of Africa, and the breaking up of China.

When should an inn keeper visit a foundry? When he wants a barmaid.

Why is an author more remarkable than a cat? Because he is the owner of many tales and they all come out of his head.

Who are the men who have made their mark? Those who can't write.

In PUZZLELAND



Tommy Riddles, the court page, announces that the King of Siam, who aspires to the hand of the Princess Enigma, submits a puzzle upon his country's flag for King Puzzlepate and his subjects to guess. The problem is to find how to cut the flag into the fewest possible number of pieces which can be refitted together again so as to bring the white elephant into the middle of the flag.

In the second puzzle Princess Enigma tests the cleverness of her royal suitor by showing a plan of her favorite orchard, which contains eight pear and eight apple trees, represented by specimens of the fruit as shown. The puzzle is to commence at any one of the eight pears and mark out the shortest possible route through the sixteen pieces of fruit which ends at the heart.

The numbers are placed on the fruit merely to enable competitors to describe their answers clearly. See if you can find a shorter route than the one marked out by the King of Siam.

The Fox and the Corn.

We have all read about the troubles of the farmer who had to ferry a fox, a goose and some corn across a stream in a boat which was only large enough to hold two, so that many trips had to be made to prevent the fox from eating the goose or the

goose from getting at the corn. Strange to say, the original farmer has now turned up and recounts that on the return trip there was no boat so he had to swim back with the goose while the fox brought the corn. He says there were twelve ears of corn in the bag, and as the fox could only cross the stream with three ears at a time, it produces a new and interesting problem to tell just how many times that fox had to cross the stream both in going and returning.

A Charade.

Though my first's a single thing,



A gypsy queen who ekes out a precarious existence by gathering quarters from gullible victims who want the future revealed, laments the decline of the fortune-telling industry as follows:

Yet many hundreds from it spring,
To men and animals a treat
For each will freely of it eat.
Now I declare it is a flower,
That sweetly scents the verdant
bower;

Within my second I discover,
The true exactness of a lover.
And when Aurora's tints are spread,
Behold my second leave its bed.
Undaunted by a sense of fear,
His courage now will soon appear.
For when contesting for a prize
He never yields, though sometimes
dies.

My whole, I now beg leave to say,
Is always deck'd in gay array.

"The week before last I earned less than three dollars, last week only a third as much and this week somewhat less than half as much as the week before." How much did she earn in three weeks?

IN PUZZLELAND



Baron Munchausen entertains our puzzlists with an exhibition of his wonderful animals. He is showing Princess Enigma his trained frogs which he calls "The Digits." He commands them to form a pyramid of nine frogs with the largest at the base, in the fewest possible number of hops, moving one frog at a time. At no time must a larger frog stand upon one of a smaller size, and the puzzle is to tell in just how few hops the feat can be performed. Numbers have been placed upon the frogs to make it easier to describe answers to the puzzle although it is only necessary to state the exact number of jumps required to perform the feat.

Little Tommy Riddle is showing the Baron's Scotch owl, which it will be remembered always made remarkable answers.

The Baron was a Scotchman and it is told that while journeying through the woods he met a wise owl and said to it, "Hoot Mon, Hoot," and the wise owl replied, "Too Hot to Hoot," which was a most remarkable answer, for no one has yet been able to discover in how many ways that one phrase can be read in those wonderful words of the wise owl!

A Charade.

If from a reasonable quantity of my second, I frequently but judiciously take my first, it will materially contribute to my third.

A Charade.

You eat me, you drink me; describe me who can!
I'm sometimes a woman and sometimes a man?

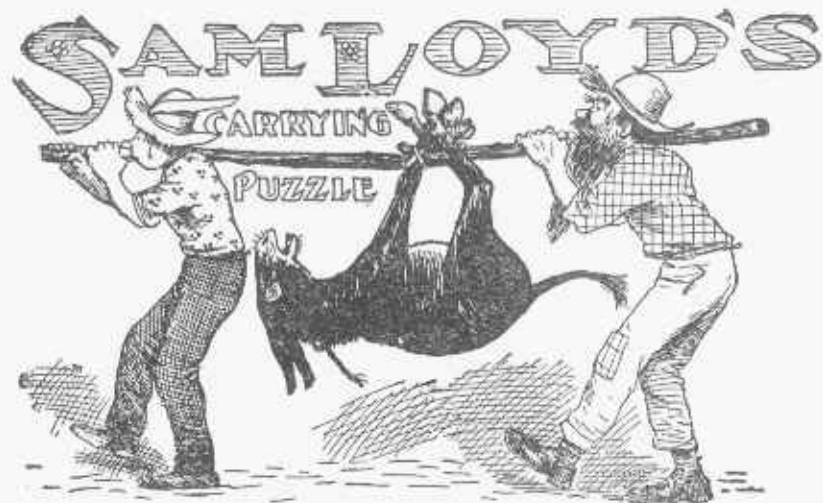

Aesop tells how a father and son failing to ride their donkey in a way to please the public, finally decided to carry the beast.

They had not gone far, however, when they met the village schoolmaster, who explained that as the

man was stronger than the boy, and the donkey weighed 220 lbs., they should adjust the position of the weight so that the man should carry 125 pounds and the boy but 95.

Where should the weight be hung if the distance from shoulder to shoulder was four feet?



Mrs. Wiggs is explaining to King Puzzlepate that there are fourteen even rows of cabbages, according to magic square rules. She asks him to take away six cabbages and leave sixteen rows with an even number in each; or to remove fewer cabbages, but to have the greatest possible number of even rows. Princess Enigma is studying the problem of how to divide one square into six squares.

soli's original design was exactly as given herewith. These interesting facts are received from a surviving brother of Mr. Plimsoll, who is a pronounced puzzlist, but who, strange to say, had never heard of a pretty puzzle connected with the Plimsoll mark which every sailor should know: Commence at one end and draw the famous mark with one continuous line by the shortest possible stroke.

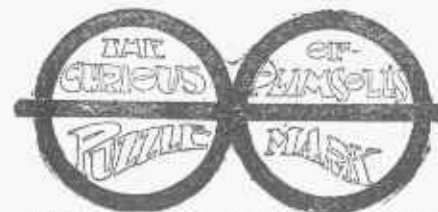

Here is a puzzle based upon the famous "Plimsoll Mark," which the late Samuel Plimsoll, M. P., known the world over as "the Sailors' Friend," after a continuous agitation for fifteen years induced the English Government to have placed upon every vessel that flies the British flag. It is placed on the extreme water line, and there are heavy fines inflicted for loading a vessel so that the mark is below the water. In one of his great speeches in Parliament he proved that more than five hundred were arrested and imprisoned for refusing to go to sea in rotten ships. He proved by statistics that instead of breaking up unseaworthy vessels, over 1,000 per year went to the bottom from overloading and over-insurance. The Plimsoll Mark is often made with only one circle, but Mr. Plim-

How long can a goose stand on one leg?
A.—Try it and see.

Who first introduced salt meat into the navy? A.—Noah, when he took Ham into the ark.

What species of bats fly without wings? A.—Brickbats.

How does a sailor know there is a man in the moon? A.—Because he has been to sea.

What fruit is the most visionary? A.—The apples of the eye.

Here is Abbot Wells Hawkes of the Jolly Friars, showing worthy Dean Charles H. Cook a puzzle which he says is just as easy as rolling off a log. Ten coins are placed upon the sixteen squares—so that you can readily discern ten rows—up, down, right, left, and diagonally, like a magic square, containing an even number of coins in each row. The puzzle is to re-arrange the coins so as to produce the greatest possible number of even rows. Another puzzling question which he asks is this: How many even rows can you produce, employing as many counters as you like?

Why is a solar eclipse like a mother beating her boy? A.—Because it is a hiding of the sun.

At what time of day was Adam created? A.—A little before Eve.

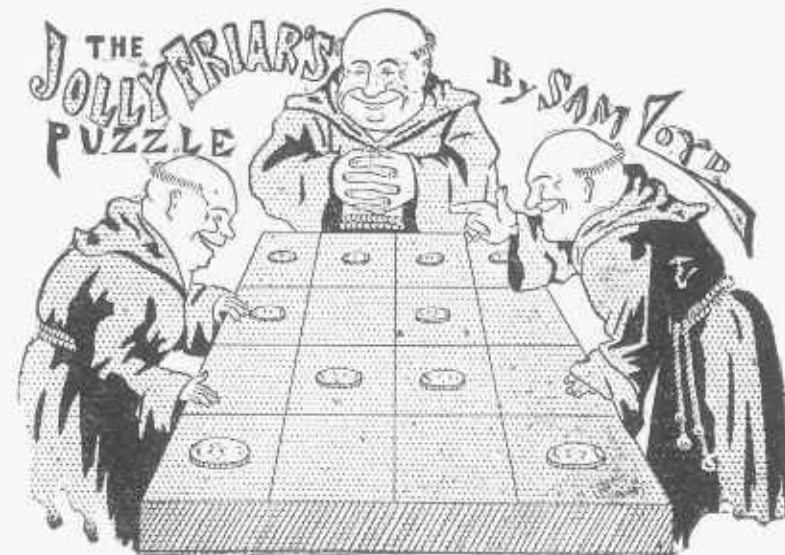

THE DANISH FLAG PUZZLE —BY— SAM LOYD.



PROPOSITION—Give the dimensions of a cross which will be just as large as the rest of the flag.

AMENT THE RECENT fruitless negotiations by Uncle Sam for the purchase of the Danish West Indies, several unique legends were brought to light regarding the titles of that group of the Virgin Islands.

St. John, St. Thomas and St. Croix, which constitute the Danish West Indies, were among the first discoveries of Columbus in 1492, but for centuries were considered of no value whatever, so when some shipwrecked Danes raised their flag as a signal of distress, the title passed into their hands without dispute, and according to custom was named after the patron saints of the mariners.

The Danish flag is so seldom seen that comparatively few persons know that it represents a white cross upon a red field, and I have never known the ensign to be constructed according to the regulations, which stipulate that half of the field should be white. Supposing, for instance, that the proportions of the flag are five feet wide by seven and a half feet long, how many of our puzzlists can find a simple rule which gives

the width of the white cross which takes up exactly one-half of the space?

A CHARADE.

My first is four-sixths of a step that is long.

My second a person of state;
My whole is a thing that we know to be wrong.

As showing a symptom of hate.
Striking.

My first is found in every house,
From wintry winds it guards.

My second you will always find
In every pack of cards.

My whole a Scottish chief well
praised

By ballad, bard and story,
Who for his country gave his life,
And dying fell with glory.
Wallace.

You eat me, you drink me,; describe me who can!

I am sometimes a woman and sometimes a man?
Toast.

My first a portion of a book,
One of the insect tribe my second;

When'er upon my whole you look,

A splendid sight it must be reckoned. Page-ant.

Sometimes, I aid the lover's cause,
Sometimes, the soldiers in the wars;
Sometimes, I with the thief conspire
Sometimes, I'm useful at a fire;
Sometimes, the carpenter befriend.
Sometimes, the bricklayers attend;
Sometimes, the gardener asks my aid.

Sometimes, I help the painter's trade;
Sometimes, naughty boys will try
By me to gain a bird's nest high.
A ladder.

What force or strength can not get through
I with a gentle touch can do,
And many in the streets would stand
Did I not prove a friend at hand?
A key.

My first makes all nature appear with one face,
My second has music, and beauty and grace;

My whole, when the winter hangs dull o'er the earth,

Is the source of much pleasure, of mischief and mirth. Snow-ball.



Tommy Riddles announces to King Puzzlepate and the fair Princess Enigma that Don Quixote wishes to exhibit a living model of the windmill monster which he defeated in single combat. The puzzle in this case which Tommy says "is a very tricky little trick," is to cut out the nine pieces and rearrange them so as to make a perfect square. This is a clever and instructive study in geometry, while the second is a tribute to poor Sancho Panza's mathematical genius. He said that when he was toss'd in the blanket he computed by Newton's law of falling bodies that he went up thirty feet, and that, as each subsequent ascent decreased by ten per cent., it should be an easy matter to tell just how far he must have travelled before he came to an actual state of rest! As he wishes to charge mileage for the distance he was thrown, he asks puzzlists to help him out with their calculations to aid him in making out his bill of damages.

A Puzzle of our Grand-daddies.



A Charade.
My second was given through my first to an old woman in the dark.

A Charade.
My first you will never find out; my second is founded in truth. I trust that you will never be my whole.

A Charade.
My first is a virgin, my second what lovers compare their mistresses' hearts to, and my whole is the name of a celebrated town in England.

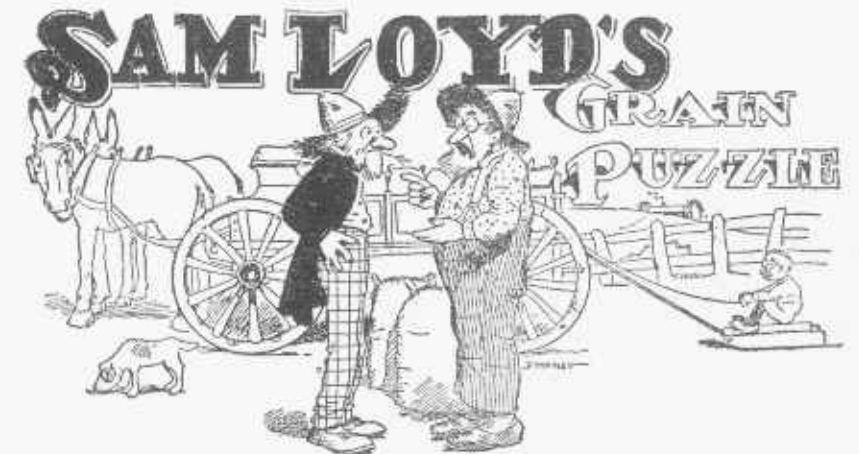

Farmer Smith worked a field of grain on shares with his neighbor Jones, agreeing to give two-fifths of the crops in lieu of rent. He took for his own use some wheat which they estimated to be worth \$50, which would be \$18.75 more than the

same number of bushels of rye, for they estimated that 13 bushels of wheat was worth \$8 more than 8 bushels of rye. As Jones preferred rye, Smith wants to know how many bushels of rye he must give him to square accounts.

Remnant Bargains Puzzle by ~ Sam Loyd



A COMPANION puzzle to Pythagora's classical problem of the combination of two squares, we offer Deacon White's bargain puzzle, which illustrates an extension of the famous Pons Asinorum. Mrs. Deacon White has purchased a piece of linoleum, and, having a little triangular piece thrown in for nothing is endeavoring, with the good Deacon's assistance, to plan how to cut the pieces so as to form a perfect square. It contains a simple but pretty geometrical principle, which you could not learn at college.

What Did She Want?

"At my home the other day a young lady from Boston astonished the household by asking the loan of a diminutive, argenteous, truncated cone, convex on its summit and semi-perforated with symmetrical indentations."

What land is like a merry dog wagging his tail? America (A merry cur).

What is the difference between a light rain and a young gentleman? One is mist and the other Mr.

A Charade

I captivate many when trained well by art,
To each lover of song an impulse impart;
Though to gay pleasure I'm closely allied,
The grave son of care to me will confide;
The miser will smile when safe with his gold
My fairest of forms he has carefully roll'd;
I useful am found in commerce and trade,
To friendship and love I lend my kind aid.
Ladies, then, while you are aspiring to me
Let virtue and worth your motto still be;
Then grandeur may frown and envy may scorn,
But happy if merit your life shall adorn.
Cipher Answer.—14, 15, 20, 5.

How far is it from February to April? A March of thirty-one days.
Who is the most popular man of letters in the country? The postman.
Why is a clergyman sometimes like a carpenter? Because he is often a joiner.

A Rebus

My first is fair and light as air,
And often meets our view;
My next adorns the rugged thorns
When wet with pearly dew.
In modest mien my whole is seen,
In yonder garden gay;
It's lovely form oit braves the storm
Of winter's closing day.
Cipher Answer.—19, 14, 15, 23, 4, 18, 15, 16.

A Paradoxical Word Puzzle

When you gaze on my face
It looks just like my back;
When my form you can trace
A woman you'll track;
And when she is found,
You'll find she is none.
Now go and "expound,"
And don't say I "poke fun."

A Charade.

My first to my second is like a twin brother,
Each seems but an echo of the other.
My whole may be heard 'mid the wild, surging throng,
Or where the cool rivulet dances along.
Cipher Answer.—13, 21, 18, 13, 21, 18.

THE GROCER'S PUZZLE



WITH ONLY 5 AND 9 POUND WEIGHTS HOW CAN HE PUT HIS 20 POUNDS OF SUGAR INTO PACKAGES OF 2 POUNDS EACH?

Of course there are many ways of doing this puzzle; for example, weigh fourteen pounds of sugar by placing the five and nine pound weights on one side of the scales, so as to leave but six pounds of sugar in the large bag. Then, weighing out five pounds more from that six with the five-pound weight, we have but one pound left in the bag, which may be used as a weight to get two pounds in each bag.

The puzzle, however, is to perform the feat in the fewest possible number of manipulations, so as to show the quickest way to do it.

A Rebus

My first is nutritive and good,
A valued part of human food.
My next oft blooming as the rose
That in yon garden sweetly blows,
My whole trips daintily along,
And cheers the hamlet with a song.
Cipher Answer.—13, 9, 12, 11, 13, 1, 9, 4.

A Charade

My first, for ages dangerous reckoned,
Was ne'er so deadly as my second.
If rightly you conjure the two,
I tell what every man should do.

A Tailor's Problem.



Here are two pretty puzzles belonging to the one design. A tailor had a remnant of cloth which he wished to cut into four pieces of the same shape and size. Show how he performed the feat by marking out a similar design. The second is a cutting puzzle. Take a piece of paper of the same shape and cut it into the fewest possible pieces which will fit together so as to make a perfect square.

A Rebus

My first, I must own, is duplicity's self,
A granted permission my second will name;
My whole will exhibit a privileged elf,
To encircle a part of your delicate frame.
Cipher Answer.—2, 18, 1, 3, 5, 12, 5, 20.

A Charade

In battlefield when front to front,
Contending armies bear the brunt,
My first is in the fray;
If e'er with quantities perplexed,
You gents may measure with my next,
Or with my total weigh.
Why is a fish hook like a horse?
They both need baiting.



Frank and Sammy bought a watermelon for forty-eight cents, Frank contributing thirty cents and Sammy eighteen, which they were going to divide in proportion to their relative investments, when, spying Billy passing on the road, they conspired to

unload a third of the melon upon him for the cost of the whole. After Billy had gone the boys proceeded to divide the money as they thought right, and then each of them ate a half of the remainder. How should the money be divided between Frank and Sammy?



Just to show how little many people who are infatuated with the races really know about the theory of chances, we ask the following simple question:

If the odds are 2 to 1 against the Hippopotamus and 3 to 2 against the Rhinoceros, what should be the odds against the Giraffe if everything is on the square, as it always is in Puzzleland?

Here is the second puzzle connected with the same picture, which shows how they make up a handicap in Puzzleland:

If the Giraffe can beat the Rhinoceros one-eighth of a mile in a two mile handicap race, and the Rhinoceros could beat the Hippopotamus one-quarter of a mile in a two mile handicap, what distance could the Giraffe beat the Hippo in the same race?

The Salary Puzzle.

Here is a problem from the ordinary affairs of life which is as interesting as it is puzzling to all who tackle it. The "Boss" was feeling pretty good the other day, so he said to his stenographer:

"Now, Mary, in view of the fact

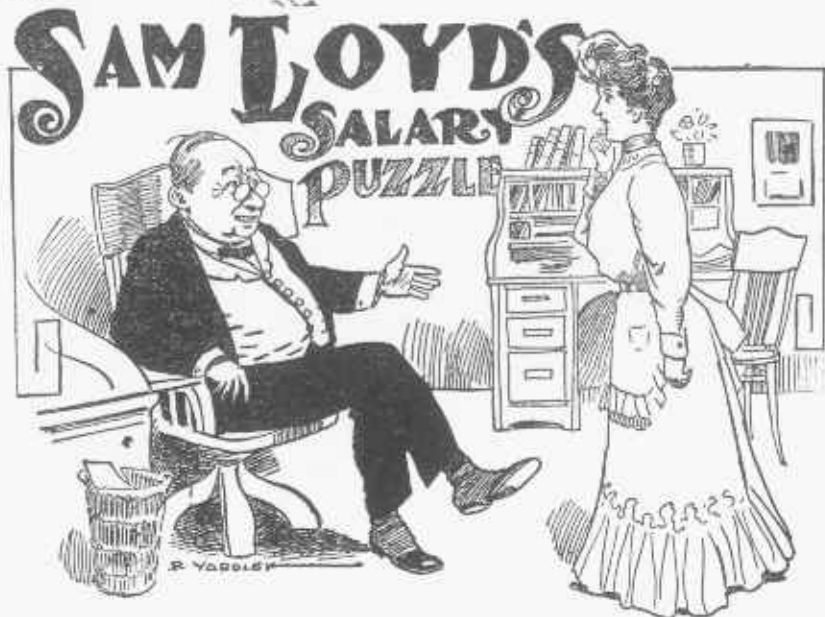

of your never indulging in useless vacations, I have determined to raise your salary \$100 every year. Beginning from to-day, for the ensuing year, you will be paid weekly at the rate of \$600 a year; next year at the rate of \$700, the next at \$800, and so on, always increasing \$100 per year."

"On account of my weak heart," replied the grateful young woman, "I suggest that it would be safer to make the change less abrupt. Start

the salary from to-day upon the basis of \$600 a year, as suggested, but at the end of six months raise it \$25, and continue to give me a \$25 raise every six months, so long as my services are satisfactory."

The boss smiled benignly upon his faithful employee, as he accepted the amendment, but a twinkle in his other eye set some of the boys to figuring as to whether or not the "Boss" made a wise move by accepting her proposition. Can you tell?

TUG O' WAR PUZZLE

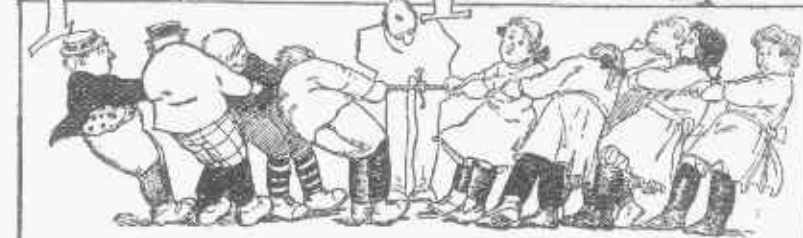

THE STOUT BOY QUARTETTE COULD TUG JUST AS STRONG AS THE PLUMP SISTERS

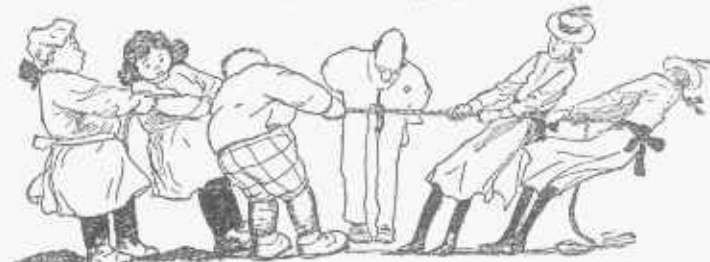

WHILE TWO PLUMP SISTERS AND A STOUT BOY COULD HOLD THEIR OWN AGAINST THE SLIM TWINS



NOW WHICH SIDE WILL WIN IN THIS EVENT?

Apropos of the popular introduction of athletics in our public schools, we will show how a little tug-of-war pull might be utilized to illustrate the principle of changing terms by substitution in algebra to clear equations. The combined pulling power of the four stout boys just equals that of the five plump sisters. As the second sketch shows the slim twins to be equal to a stout boy and two plump girls we will at once simplify matters in the third illustration by changing the two slim twins for their equivalent in pulling power, so we substitute the fat boy and two plump girls. By this change we now have in the third picture five plump sisters and one stout boy opposed to one plump girl and four stout boys, so we cancel off five plump girls from one side and four stout boys from the other, because the first sketch gave it as their relative pulling power, and we are left with one girl on the right as opposed to one boy which proves that

the left hand team should win in the third sketch as it has one-fifth of a boy's strength more than the other team. The mathematical professor who umpired the match said in his award, "∴ as 25 : 24 :: the left team : the right."

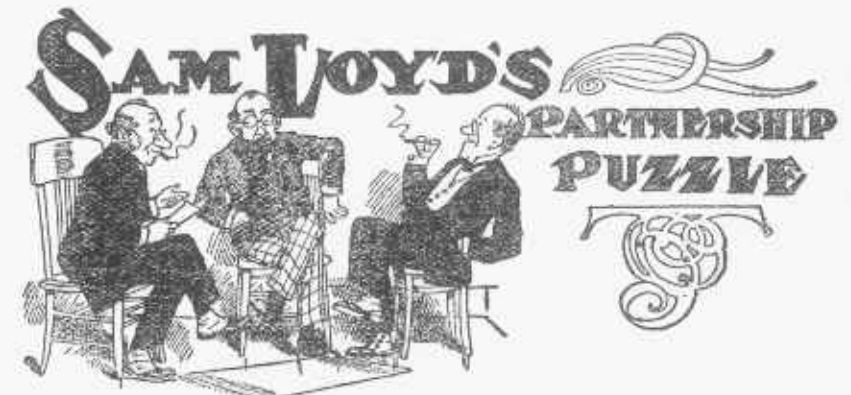

Here is a practical problem from common, every-day affairs which is well worthy of your consideration: In the old firm of Brown & Jones, Brown had one and a half times as much capital invested in the business as

A Rebus
To boast of my first would but shallow be reckoned,
To all it has happened, and that at my second;
But who is so unfeeling, so callous of soul,
As not to rejoice at the sight of my whole?
Cipher Answer.—2, 9, 18, 20, 8, 16, 12, 1, 3, 5.

A Charade
Ye bards, perhaps my first may do Ere you begin to sing;
My second oft salutes the ear When horrid wars begin.
My whole denotes a stupid elf,
So find this out, to clear yourself.
Cipher Answer.—8, 21, 13, 4, 18, 21, 13.

A Rebus
Miss Ann was only five years old,
And scarcely yet was able,
Upon my first, as I am told,
To reach above the table.
Yet she my second took, queer soul,
And for no other reason
Than that mamma refused my whole
Until another season.
Cipher Answer.—20, 9, 16, 16, 5, 20.

A Charade
My primal is found where the wild waves are dashing,
And thick falls the cold, briny spray;
My final is seen where the fierce eyes are flashing,
And fortunes are thrown away.

Jones, when it was decided to admit Robinson upon the payment of \$2,500, which was to be divided between Brown and Jones, so that the interests of the three partners would then be equal. How should the \$2,500 be divided?



THE GRACES AND THE MUSES
A CLASSICAL PROBLEM
BY SAM LOYD.

PROPOSITION—If the Three Graces, with roses of varied hue, meet the Three Graces laden with golden apples, and each Muse gave each Grace the same quantity of roses and received the same quantity of apples, how many of each did they have?

THERE IS A GRECIAN fragment from ancient mythology, ascribed to different ages and to as many different men. The problem feature has been accredited to Euclid and Archimedes, although it is known that Homer sang of the mythical daughters of Zeus, with their apples and roses many, many centuries before.

The problem of the Graces dividing their flowers with the Muses may be as old as the Pyramids, and yet, although I have seen it clothed in many forms as a tit-bit of classical lore, I have never known of an attempt to analyze or throw light upon that part of the legend which seemingly conceals a mathematical mystery.

The story would be clearer to our puzzlists, perhaps, if I gave the original Greek, but he is away, and as our font of Greek type is somewhat out of sorts, I am compelled to give what might be called a very freehand translation, keeping as close as possible to the literal wording of the original, which differs materially from the meaningless version so often published in puzzle books:

Problem of the Graces and Muses.

As through Olympian garden bowers
Strolled three fair Graces, culling flowers
Of perfume rare, and varied hue,
From pink and white to red and blue,
They chanced nine Muses fair to meet,
With golden stores of apples sweet.

Each Muse, in turn, to every Grace
Some apples gave, and in their place
Such roses did receive as made
Their stores all just alike, 'twas said,
Now, if the numbers were the same,
The quantities of each proclaim!

I do not believe that a dozen lexicons would make the meaning plainer. There were nine Muses with roses of various hues, as described, who met three Graces laden with golden apples. Each of the Muses gave to each of the Graces, and each of the Graces gave to each of the Muses, so that 'twas said' all their stores were just alike—every Muse and Grace having a similar stock representing an equal number of apples and roses. It is a pretty puzzle for our muses to muse over,

Why are pianos noble characters? Because they are grand, upright, and square.

Why is a dog biting his tail like a good manager? Because he makes both ends meet.

What is the difference between a glass of water and a glass of soda water? Five cents.

Why is a good cabbage the most amiable of vegetables? Because it is all heart.

Why is an intoxicated man like a noun adjective? Because he seldom stands alone.

Why is a clergyman's horse like a king? Because he is guided by a minister.

Why is a man in a garret committing murder like a good man? Because he is above committing a bad action.

Why is an avaricious man like one with a short memory? He is always for getting.

What is that which lives in winter, dies in summer, and grows with its root upward? An icicle.

Why is a handsome woman like bread? Because she is often toasted.

Why should watermelon be a good name for a newspaper? Because its insides would be read.

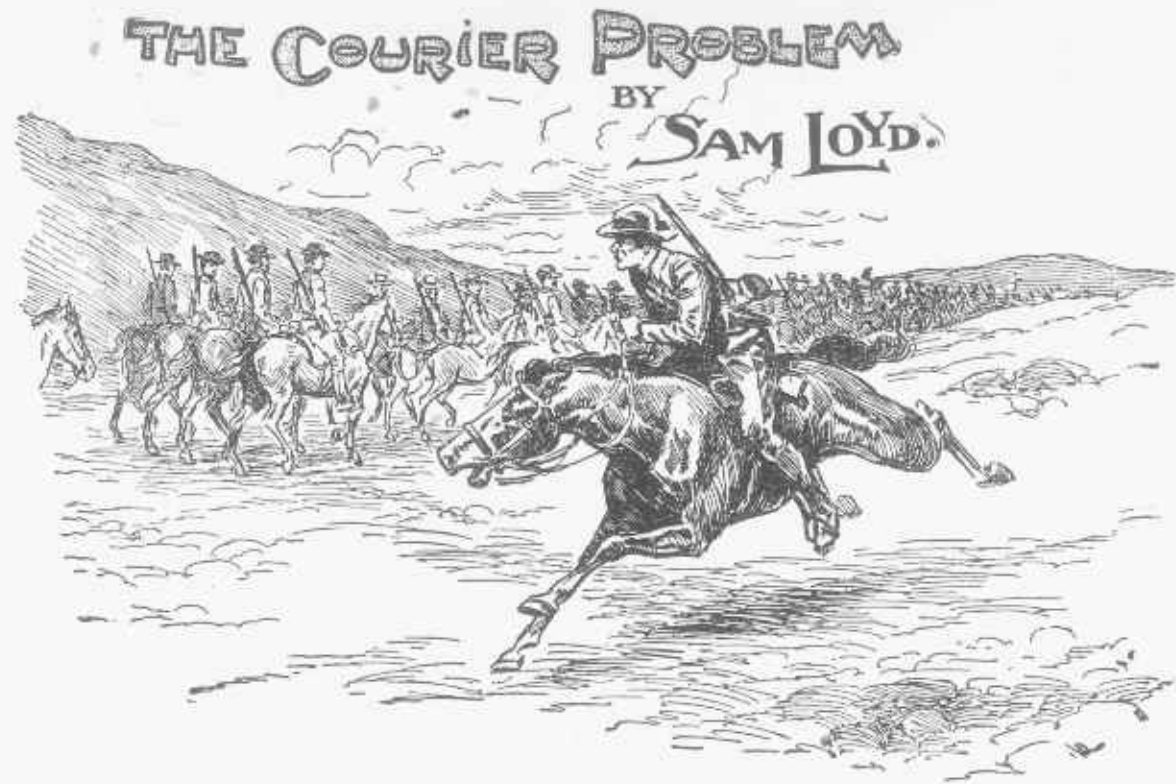

PROPOSITION—An army 50 miles long advances 50 miles while a courier goes around it.



FOR THE REASON that many communications are being received relating to a very ancient problem, the authorship of which has been incorrectly accredited to me, occasion is taken to present the original version which has led to considerable discussion. It has been reproduced, in many forms, generally accompanied by an absurd statement regarding the impossibility of solving it, which produced letters of inquiry, as well as correct answers from some, who, under the misapprehension of having mastered a hitherto unsolved problem, desire to have the same published.

It is a simple and pretty problem which yields readily to ordinary methods, and can be solved by experimental analysis upon the plan generally adopted by puzzlists. The trouble is that the terms of the problem are seldom given correctly and are not generally understood, for which reason, with the aid of a realistic picture, we will first look at the ancient version which appears in the oldest mathematical works:

A courier starting from the rear of a moving army, fifty miles long, dashes forward and delivers a dispatch to the front and returns to his position in the rear, during the ex-

act time it required the entire army to advance just fifty miles.

How far did the courier have to travel in delivering the dispatch, and returning to his previous position in the rear of the army?

If the army were stationary he would clearly have to travel fifty miles forward and the same distance back. But under the circumstances as stated, he must go more than fifty miles to the front, as the army is steadily advancing; on his return trip he meets the army and therefore does not have to travel so far. To those who are familiar with the rules which govern the question it is a simple matter, but to most people it will prove to be a problem which can not be guessed off hand.

A better puzzle is created by the following extension of the theme given as problem No. 2:

If a square army, fifty miles long by fifty wide, advances fifty miles while a courier makes the complete circuit of the army and returns to the starting point in the rear, how far does the courier have to travel?

It is self evident that the courier would have to ride two hundred miles if the army were stationary, so the point of the problem turns upon ascertaining how much he gains or loses by the advance.

Which is the favorite word with women? The last one.

At what age should a man marry? At the parsonage.

Why is an egg underdone like an egg overdone? They are both hardly done.

Why is a very old umbrella, that has been lost, as good as new when found? Because it's re-covered.

Why do the Salvation Army lassies walk on their heels? To save their soles (souls).

Why is the letter W like gossip? Because it makes ill will.

Which is the oddest fellow, the one who asks a question or the one who answers? The one who asks, because he is the querist.

When does the wind most resemble a bookseller? When it keeps stationary (stationery).

What benefits can be derived from a paper of pins? It will give you many good points.

When is a new dress older than an old one? When it's more (moire) antique.

What plant is most fatal to mice? Cat-nip.

Why are balloons in the air like vagrants? Because they have no visible means of support.

If I were in the sun and you were out of it what would the sun become? Sin.

THREE LITTLE BOYS FOUND

a well-filled pocket-book, and despite the fact that they had no more firecrackers and were financially broke, they promptly returned the wallet to a nice old lady, who was walking on the same block, and who proved her ownership by naming the contents. To reward the boys for their honesty she took what small change there was in the book and gave it to them. There was just 58 cents in six coins, but as it could not be divided into three even parts, she gave the eldest of the boys one coin, and then divided the remainder evenly between the other two boys, but told them to invest the entire amount in firecrackers, which they could divide more equitably.

There seems to be but little data to figure from, nevertheless, as there are several divisions of six coins which would fill the bill, I think our puzzlists should have no trouble in guessing the amount of that coin which the kind old lady gave to the oldest boy.

Why is the letter y like a young spend-thrift? Because it makes pa pay.

INVESTMENT PUZZLE.

The Smiths were purchasing a suburban villa when Smith remarked:

"If you give me three-quarters of your money I can just take the \$5,000 house and you will have enough left to buy the shady grove and running stream?"

"No, no," replied his better-half, "give me only two-thirds of your money and I will buy the house and you will have enough over to purchase the grove with the babbling brook."

Can you figure out the value of the shady grove with its never-falling stream?

THE COIN PUZZLE

BY SAM LOYD



Eight children divided 32 apples as follows: Ann got one apple, May two, Jane as many as his sister and Jack Robinson three and Kate four. Ned Smith took as four times as many as his sister. The puzzle many as his sister, Tom Brown twice as is to prove the full names of the girls.

SAM LOYD'S

APPLE PUZZLE



SAM LOYD'S INVESTMENT PUZZLE



What is that which is often found where it is not? Fault. What does a man want when seasick aboard ship? He wants the earth.

IN PUZZLELAND

WILLIAM TELLS ABOUT SHOOTING APPLES



We are told that William Tell scored 100 points in the apple-shoot game at a distance of thirty-five yards. Can you tell which apple he must have hit, and what was the height of the flagpole on the top of which was placed Gessler's cap, which we are told William Tell refused to salute?

IN SEARCH OF KNOWLEDGE.

"I say, pa," began little Clarence Callipers, with the rising inflection of one who earnestly desires to acquire important information, "if—"

"Oh, I don't know!" replied his long-suffering sire wearily.

"You don't know what, pa?"

"I don't know the answer to the question you are about to ask."

"Why, you don't know what I am going to ask, do you, pa?"

"No, of course not!"

"Then if you don't know the question, how do you know you don't know the answer to it, pa?"

"Because I know I don't know! I don't know why it is that the more a man gets, the more he wants, and the more he wants, the less he usually gets, nor why so many men with big heads wear such small hats, nor any of the other foolish questions you always ask."

"Yes, sir. But the question I wanted to ask isn't foolish, pa."

"H'm! If it isn't foolish, you may go ahead and ask it. But remember, just one question and no more."

"Yes, pa. I just want to know, if five times four was thirty-three, how much would the fourth of twenty be?"

"We would like to know how many readers can tell what reply papa should have given?"

Here is an amusing novelty for the little folks. First cut the elephant into six segments then arrange them so as to show how he runs when he is in a hurry.

What animals are always seen at funerals? A.—Black kids.

What should a clergyman preach about? A.—About a half of an hour.

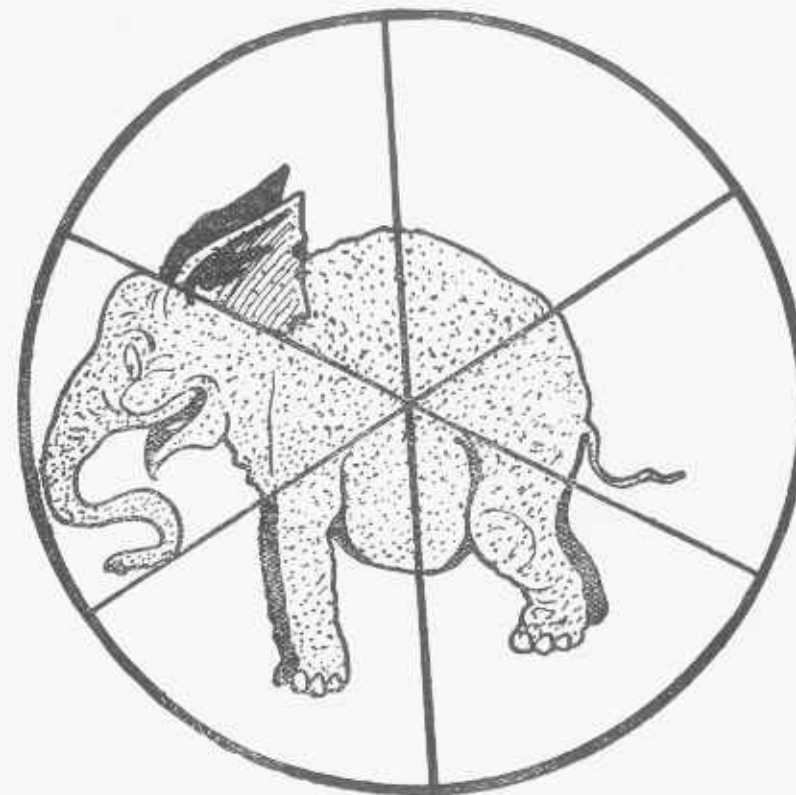

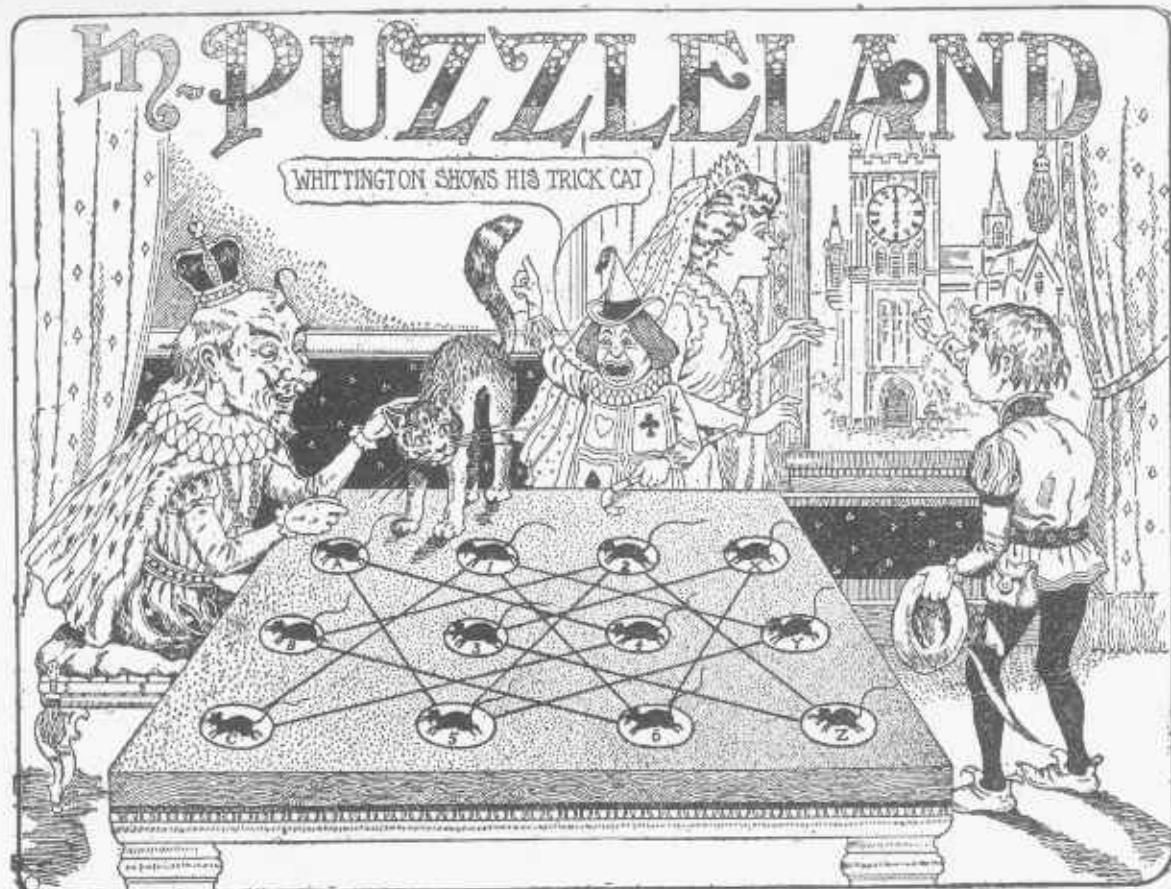

Whittington is showing his trained cat in its algebraical feat of going from A to Z by the shortest marked route, which takes up all of the mice. He then calls attention to the clock on the tower of London and asks: If it takes six seconds for the clock to strike six, how long would it take to strike eleven?

THE LOST STAR.

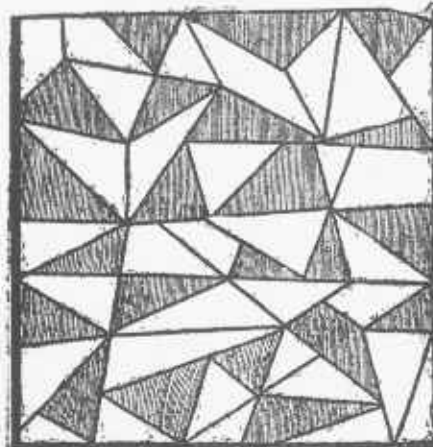

Here is an astronomical study for the little folks, although it may puzzle the grown ups as well. See how long it will take you to discover a perfect star in the above general mix-up.

What is the most cheerful part of an arsenal? The ballroom.

Why is counterfeit money like gooseberry pie? Because it's not currant (current).
 Why is a doctor like a glazer? One takes the pain out and the other puts it in.
 How is it that Methuselah was the oldest man when he died before his father? His father was translated.
 Why is a conundrum like a monkey? Because it is far fetched and full of nonsense.
 What do we all do when we first get into bed? Make an impression.
 Why is a joke like a cocoanut? Because it ain't no good until it's cracked.
 When did Esau, the hairy man, lose his whiskers? When his brother Jacob shaved him.
 Who was the heaviest of men? Ful-ton.
 What is the difference between Joan of Arc and Noah's ark? One was Maid of Orleans, the other was made of chittim wood.
 Why is a horse like the prophet Elijah? He is fed from a loft.
 Why is a new married man like a horse? He is a bride-led.

What number is that, which, added separately to 100 and 164, shall make them perfect squares? 125.
 Why is a gristmill like an orange tree? Always in flour.
 Why is it dangerous for a teetotlar to have more than two reasons for the faith that is in him? Because three scruples make a dram.
COMING TO TOWN PUZZLE.
 Uncle Reuben and Aunt Cynthia came to town the other day to shop. Reuben bought a suit and hat for \$15. Cynthia paid as much for her hat as Reuben did for his suit, and she then invested the remainder of their money in a new dress.
 On the return trip Cynthia, who had "been thinking" over a remark of Reuben's about her hat costing as much as his suit, called attention to the fact of his hat having cost \$1 more than her dress, and suggested that if they had portioned their hat money so that her hat would have cost half as much more than his, they would each have spent the same amount of money, to which Reuben replied: "How much would my hat have cost?"

A COMING TO TOWN



Odds and Evens
 PUZZLE
 BY

Sam Loyd



Here is a pretty little puzzle which reads as if it had some political significance appropriate to the times, and which will probably repay those who study it out:

It appears that three little urchins who had formed a working partnership found themselves at the end of a day's labor with \$3.90, represented by seven coins. As the coins could not be divided into three even portions they appealed to a man whom they found seated on the fence, who apparently had plenty of time on his hands to devote to anything that might turn up. After listening to their statement he took one of the coins and coolly putting it into his pocket, remarked in a superior sort of way: "You will now find no trouble in dividing the six coins so that you will each have the same amount. You will not miss that one piece of money, and it will repay me for the thought I have devoted to the question. All troubles arise from attempting to do even things in an odd way; now run away and be prosperous."

Now tell what were the seven coins, and how did they divide them?

What is the difference between a boy and His shadow? The boy can see his shadow, but the shadow cannot see him.

How can a person live eighty years and see only twenty birthdays? Be born on the 29th of Feb.

ANNUITY PUZZLE.

Jones settled an annuity upon his three daughters, to be divided each year in the same proportions as their ages.

At the first payment the eldest was entitled to one-half of the entire amount. When the sixth payment was due, Martha received one dollar less than she had the first year. Phoebe one-seventh less than she first got, while Mary Ann's share was twice as much as she received the first year. Now who can tell the amount of the Jones annuity?

A REBUS.

I am bright as a whole
 Till you cut off my head;
 Then as black as a coal,
 Or a mortal instead.

Shaken up and recast
 We with science are found,
 Read us back from the last
 And we live under ground.

Answer—19, 20 1, 18.

SAM LOYD'S ANNUITY PUZZLE





Every game of skill, such as Chess, Checkers, Cards, Billiards, etc., etc., afford opportunity for the display of proficiency in the shape of problems or puzzles. I have always taken the same interest in such problems as in the style of puzzles which appear on these pages.

THE WHIST PROBLEM.

The above picture illustrates a simple ending at the Whist Club, where each player has five cards left. Diamonds are trumps and it is for South to play. How can they capture all five tricks against the best possible defense?

Here is a clever chess problem which tells its own story to those who play the game.



A BILLIARD PROBLEM.

Eliminating the question of English, how would you send your ball, so as to hit all four cushions and return to the starting point?

First place the ball at one end of the table, against the cushion, seven inches from a corner, before striking it with the cue.

What relation is the door mat to the scraper? A step farther.

Why is a woodman like a stage actor? He is known by his axe (acts).

BYRON'S ENIGMA.

I'm not in earth, nor the sun, nor the moon;

You may search all the sky—I'm not there;

In the morning and evening—though not in the noon—

You may plainly perceive me, for, like a balloon,

I am midway suspended in air. Though disease may possess me, and sickness and pain,

I am never in in sorrow nor gloom; Though in wit and in wisdom I equally reign,

I'm the heart of all sin, and have long lived in vain,

Yet I ne'er shall be found in the tomb.

SAM LOYD'S WHIST PUZZLES



Here is a five-card ending which occurred at the Bridge Club: Hearts trumps and South to play; with North as partner take four out of five tricks.

A REBUS.

Let my second cut my first,
Then cut me at the table;
Though I cannot quench your thirst
Eat me—you are able.



Occasion is taken, therefore, to mention that I have composed upward of a thousand chess and whist problems which have met with the approval of experts.

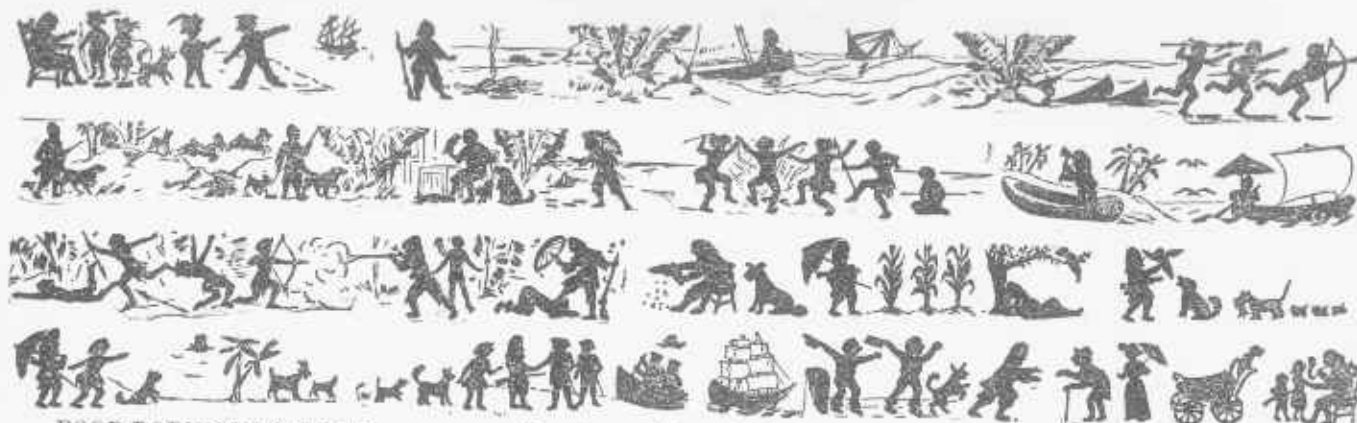

POOR ROBINSON CRUSOE.

The above pictured story is given as supplementary to our former illustrations of silhouette cutting of which some specimens have already been given. It is safe to say that there is no accomplishment so readily acquired, which affords such endless amusement as making pictures in black and white.

Just a sharp pair of scissors and a sheet of paper, that's all that is required. Any one can speedily learn to make "paper people," animals, etc., and soon they will be able to cut portraits and then they have acquired an accomplishment which is never forgotten. I learned to cut portraits at a very early age, and it has been a great pleasure to me throughout my entire life.

If a woman stands behind a tree, how does the tree stand? In the ground.

Wherein does a turkey cock differ from a lady? He flourishes his fan behind.

Why are cashmere shawls like deaf persons? Because we cannot make them here (hear).

Why is an Indian like a flirt? He has many cast-off bows (beaux).

Why is an Indianlike a scholar? He is a well re(a)d man.

Why is marriage like truth? Because it is a certain tie (certainty).

Why is an unpaid bill like the moisture of the morning? It is due.

Why is a sanguinary epistle like a surgeon? It is a letter of blood.

Why is a lost child like you? He gives it up.

Why were Hebrews called sheep? Descended from A-ram.

What is the most suitable dance to wind off a frolic? The reel.

REAPER'S PUZZLE.

Greenleaf (1860), gives a totally incorrect answer to the ancient problem of two men who were to receive 90 shillings for harvesting a field conditionally upon the work being done in five days. Jake could handle it alone in nine days, but as Ben was not so good a worker they were compelled to engage Bill for two days, in consequence of which Ben got three shillings and nine pence less than he otherwise would have received. How long would it have taken Ben and Bill to have completed the work?

Here is another of the old-style illustrated rebusses of the times of our grand-daddies:



What stone opens and shuts at your convenience? A-gate.

Why is a thing purchased like a shoe? It is sold.

Why was Daniel like Nebuchadnezzar's image? Because the lions could not eat him.

What island in the Pacific is always at see-saw? Hi-lo.

What is an elephant like a lady's veil? Because there is a "b" in both.

Why is a butcher's dog in the parlor like your mother receiving strange company? He is ma, stiff.

Why should a hound never be admitted into the house? He chases the deer (dear) and is never chased (chaste).

When is a boat like a knife? When it's a cutter.



There is no puzzle about this picture; it is merely an illustration of the two-headed monster which Jack the Giant Killer slew, the only question involved being: Was it a two-headed or a three-headed Giant that was killed?

Why is a dandy like a haunch of venison? He is a bit of a buck.

Why should doctors attend to window sashes? Because they have so many pains (panes).

What animals are like an apothecary? The ass, because he brays; Dr. Pott's horse, because a Pott he carries.

What animal is like a stone breaker? A rooster, because he picks and crows.

What part of a ship was made of Cain? The tiller.

SAM LOYD'S REAPER'S PUZZLE



ABOUT MAGIC SQUARES.

The arrangement of numbers in the form of squares so that they will add up the same amount in every column and row, as well as in the two diagonals, is without doubt the oldest of all mathematical puzzles. It was held in great veneration by the Egyptians; and the Pythagoreans, to add more efficacy and virtue to the magic square, dedicated it to the then-known seven planets. In later times, when mathematics was supposed to pertain to magic and the black art, these squares were allied with superstition and held in sacred veneration. To this very day the Chinese and Korean soldiers carry charms in the forms of magic squares to protect their lives, and on the eve of battle scatter certain forms printed on pieces of paper to insure luck and to discomfit the enemy.

This strange freak of figures may be found in Durer's "Melancholia" engraved on copper in 1514.

As shown by ancient writings, the aim was not only to add up the same amount (34) in the ten rows of four, but to discover in how many symmetrical combinations that same amount can be discovered. Take the squares 16, 3, 5 and 10, or 2, 13, 11 and 8, or 9, 6, 4 and 15, or 7, 12, 14 and 1, as well as 10, 11, 6 and 7. According to ancient lore, "symmetrical combinations which no man could number" were to be found in this arrangement of the figures, from which we infer was meant symmetrical selections like the four corners 16, 13, 4 and 1. The opposite sides, 3, 2, 15 and 14, or 5, 9, 8 and 12, as well as any possible symmetrical set of opposite position which can be hit upon, like 5, 3, 12 and 14, or 2, 8, 9 and 15, as well as combinations on the knight's tours, like 3, 8, 14 and 9, or 2, 12, 15 and 5, or 16, 11, 1 and 6, and 4, 10, 13 and 7. Rhomboidal forms, like 1, 9, 16 and 8, or 1, 2, 15 and 16, or 4, 3, 13 and 14, and all similar shapes, produce the required 34 and go far to bear out the extravagant claims of the Orientals. Magic squares are divided in two classes—the even and odd number of squares—and many rules have been discovered for producing them in endless variety, so that it is no longer considered to be a meritorious feat to build them up to extraordinary size. Our illustration shows the familiar arrangement of the nine numbers which adds up 15 in eight directions, but if allowed to duplicate any numbers you wish, in how many possible directions can the same addition be shown?

Can you discover how many times the four words can be spelled in this clever square-word puzzle?

DELF
EVIL
LIVE
FLED

A HIDDEN PROVERB.
Yet I see them all! on golden wings that fly,
Old memories steal anew;
With a tear, with a sigh, with an old cry,
They return in ghostly hue!

Which of the English poets would be most likely to make a lion feel at home? Dry-den.

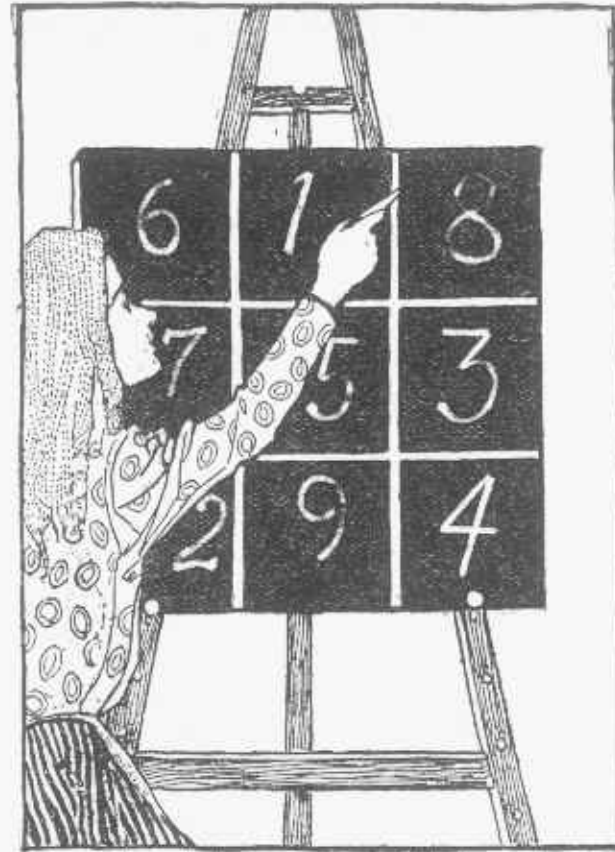

When a boy falls, what does he fall against? Against his will.

When a boy is caught stealing, what does he catch? A whipping.

Why is Tom Tumbledown like Adam when he saw the apple? He is about to fall.

Why is a picture surrounded by books like a happy man? It is in a good frame of mind.

What bird is that which has no wings? The jail bird.

Add something to 9 and make it less. IX—SIX.

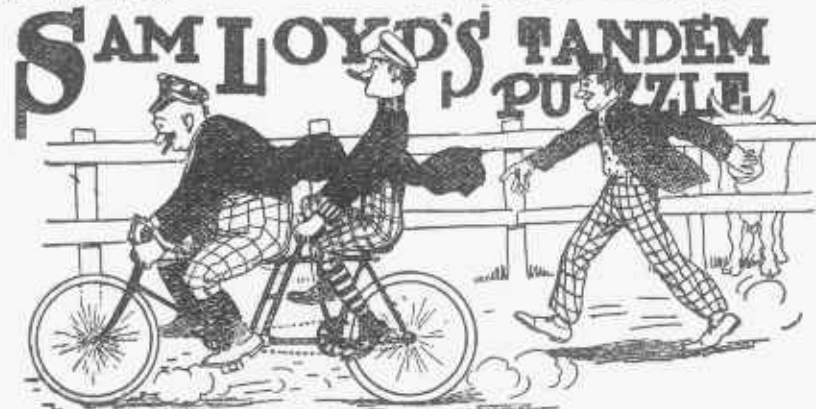

Three men had a tandem and wished to go just forty miles. It could complete the journey with two passengers in one hour, but could not carry the three persons at one time. Well, one who was a

What poet do miners value most? Cole-ridge.

What poet is least distinguished for brevity? Long-fellow.

What two syllables of the marriage ceremony are most interesting to the priest? The last two—mon-ey.

Why were the Amalakites never allowed to speak? Because their king was a-gag.

What part of a house measures two quarts? The stoop.

good pedestrian, could walk at the rate of a mile in ten minutes; another could walk in fifteen minutes, and the other in twenty. What would be the best possible time in which all three could get to the end of their journey?

Just to show the style best calculated to sell in the stores or by street hawkers as a novelty, occasion is taken to illustrate the famous "Get Off the Earth" puzzle, of which over ten millions were sold to the public. The puzzle was printed in bright colors upon two movable pieces (which cannot be shown here). You first see thirteen men, and then only twelve, and the puzzle is to tell which man disappeared.

Out of many hundreds of thousands of attempted answers, the most idiotic of which recently appeared in the LONDON STRAND MAGAZINE, not one explained the mystery, for which reason Mr. Loyd has issued a new puzzle called TEDDY AND THE LIONS, which fully refutes all so-called explanations.

\$1,000 worth of prizes being offered for the best answers received during the year 1909.

THE HUMANE ARAB.

An Arab came to the river side
With a donkey bearing an obelisk,
But he did not venture to ford the tide,
For he had too good an *.
So he camped all night by the river side,
Secure till the tide had ceased to swell,
For he knew that whenever the donkey died,
No other could be its ||.
*Find a word for this. ||A suitable word here.
Answers—1, 19, 20, 5, 18, 9, 19, 11 and 16, 1, 18, 1, 12, 12, 5, 12.

There are three hidden cities here besides Dover and Kent;
Wait while I think the matter over,
On holiday intent;
The best I've seen is surely Dover,
That pretty port of Kent.
Answer—12, 5, 9, 20, 8-20, 8, 5, 2, 5, 19 and 19, 20, 9, 22, 5, 22.

Why is a tailor finishing your pants like a polite host serving his guests with water fowl? He presses them with a goose.
What was a month old at Cain's birth that is not five weeks old now? The moon.
What looks worse on a lady's foot than a darned stocking? One that needs darning.
What flies high and low, wears boots and shoes, but has no wings or feet? Dust.

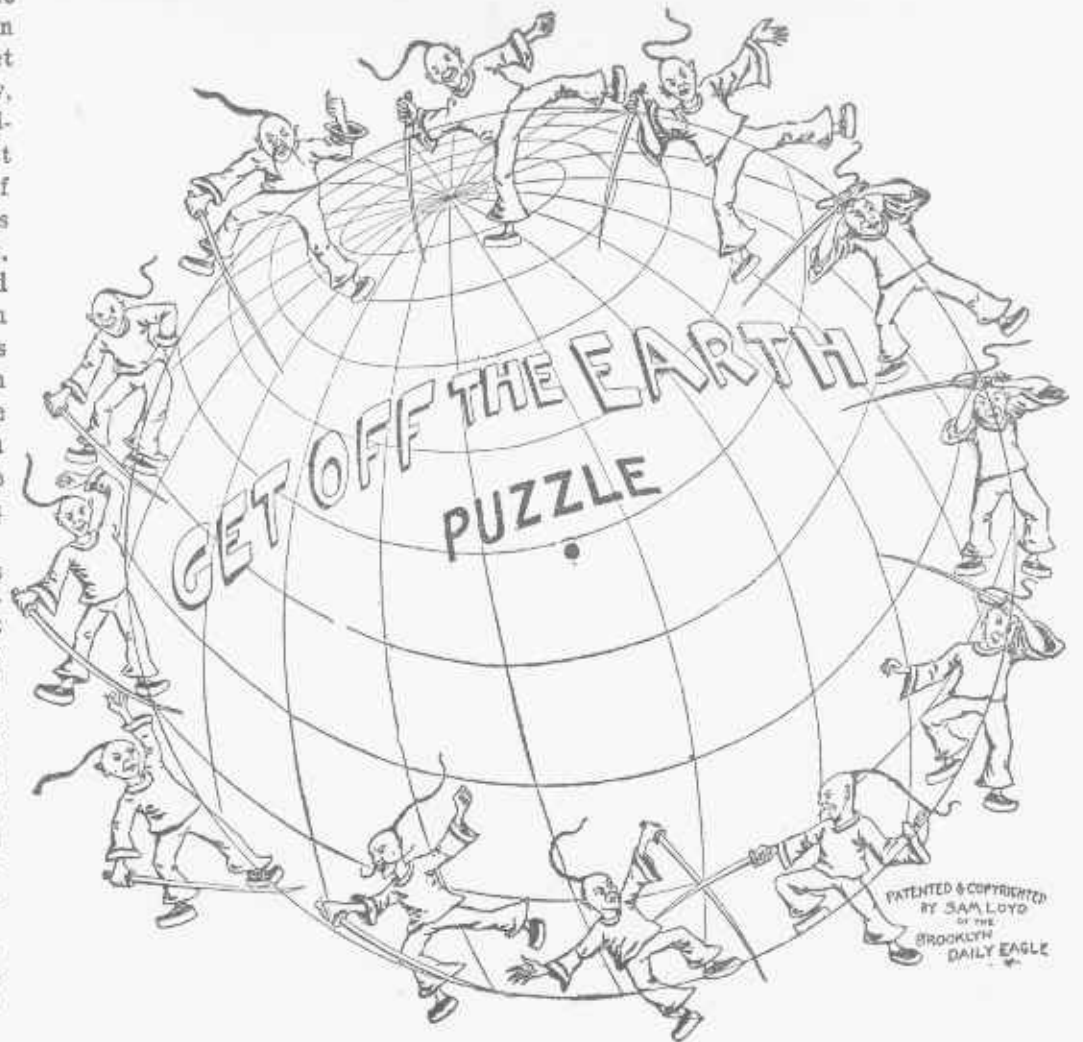

Why is a cook more noisy than a gong? The gong makes a din, the cook makes a dinner.
In what do grave and gay people differ at church? One close their eyes and the other eye their clothes.
Why is a spotted dog most reliable? He is always on the spot.
What little animal is made big by taking one letter from its name? F-ox.

Of what trade is the sun in May? A tanner.
Spell hard water with three letters. Ice.
What word is that to which, if you add a syllable, will make it shorter? Short.
Why is your favorite puppy like a doll? Because he is a pup-pet.

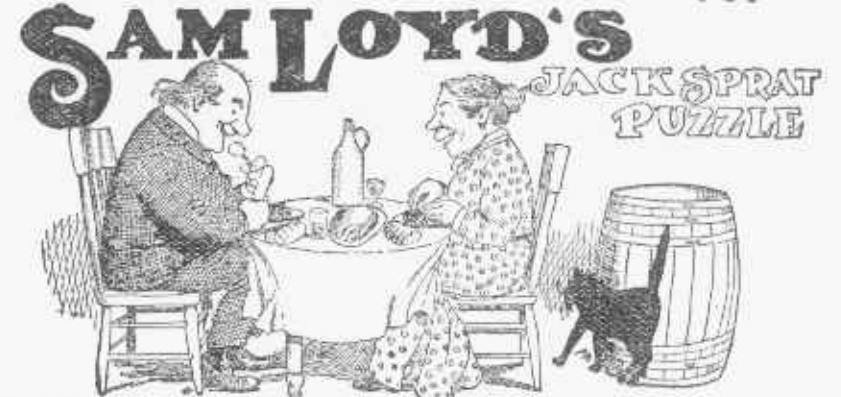

According to Mother Goose, Jack Sprat and his wife together could eat a barrel of fat pork in sixty days, whereas it would take him thirty weeks to perform the feat alone. We find that together they could consume a barrel of lean pork in eight weeks, although she alone could not dispose of it in less than forty weeks. Now figure out how long it would take both of them together to eat a barrel of mixed pork, half fat and half lean.

Here is a pretty little game, as well as a puzzle: Place a counter, supposed to be a turkey, on No. 7, and a man on No. 58. Move alternately in any direction, in straight lines, as far as you please. There is a choice of fifteen moves, but you will lose if you attempt to pass over a spot guarded by the opponent. If the man moves at first to No. 4 or 51 he would be taken at 12 or 52. No matter who begins, the man can capture the turkey. But in how many moves? The puzzle is to stand the turkey on No. 7 and start the man from No. 58. The turkey does not move, but the man must capture it in 24 moves after passing over every spot but once. It is quite a difficult problem.

Why is a farmyard like a hotel? It is generally patronized by gobblers.

A charitable lady met a poor man, to whom she gave 1 cent more than a half of all the money she had in her purse. The poor fellow, who was a member of the United Mendicants' Association, managed while tendering his thanks to chalk the organization's sign of "a good thing" on her clothing, so that she met many objects of charity as she proceeded on her journey. To the second applicant she gave 2 cents more than the half of what she had left, and to the next she gave 3 cents more than half of the remainder, and then found that she only had 1 cent left.

How much money had she in her purse when she started out?

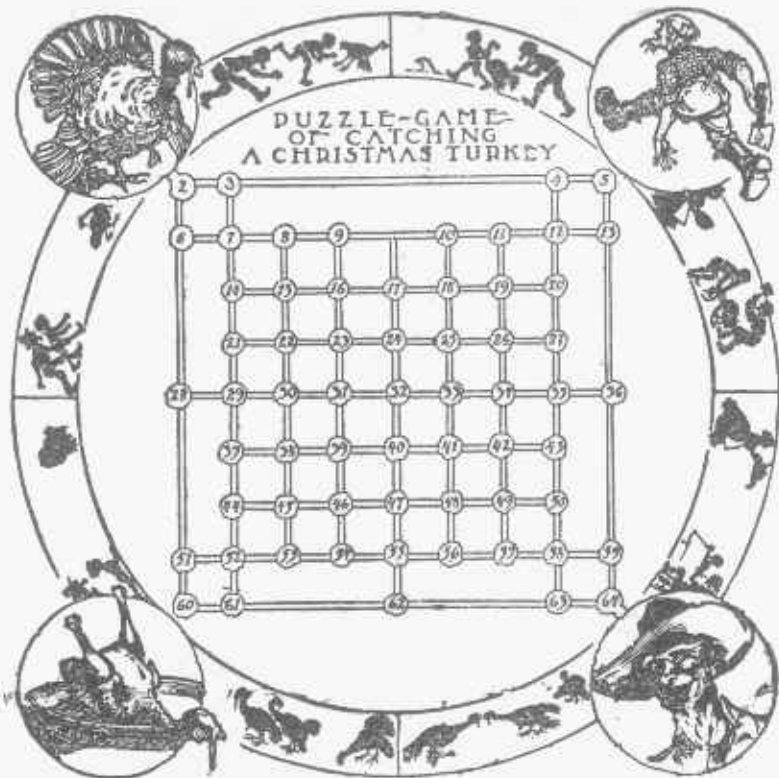

SAM LOYD'S CHARITY PUZZLE



Why is a man with wooden legs like one who has an even bargain? Because he has nothing to boot.

What fish does a bride wear on her finger? Her-ring.

Aunt Mary brought some peanuts at the Zoo for the children and gave to the eldest, a boy, one peanut and one-quarter of the remainder. The little tot also received one likewise gave one peanut and one-quarter of the remainder. To the third, a boy, she also gave one peanut and one-quarter of the remainder. The little tot also received one peanut and one-quarter of what was left.

It was then found that the boys had received one hundred more peanuts than the girls. From these facts you are asked to determine how many peanuts Aunt Mary kept for herself.

Why are handsome women like bread? Because they are often toasted.

Why is an avaricious man like one with a short memory? Because he is always for-getting.

Why is a parish bell like a good story? Because it is often tolled (told).

What kind of morals are easily put on and off? Bal-morals.

SAM LOYD'S PEANUT PUZZLE



What is that which is insivible, but never out of sight? The letter "s."

Why are most of the heroes and heroines in novels like the letter O? They are always in love.

Why is a ship under full sail like Niagara? Because she shows her flowing sheets.

What animal resembles the sea, and why? The lion, because he roars and has a flowing mane (main)

What animals are the most windy, and why? The lion, because he bellows, and the whale, because he blows.

What belongs to yourself yet is used more by others than yourself? Your name.

Why is a nail fast in a wall like an old man? Because it is in firm (infirm).

Have you ever noticed how difficult it is to tell the time on a clock by seeing it reflected in a looking glass? Some positions are very simple but others are quite perplexing, the more so if it be a watch with a second hand and you are requested to tell the position of the three hands at once.

Harry has a very pretty puzzle to solve this time, so see if you can help him. The clock has stopped, but it is so distant that he cannot tell the hour from the minute hand, but he can see that they are the same distance from the number 12. At what time of day did the clock stop?

ACCIDENTAL BURIALS.

The old-style concealed-word puzzle seems to be the only one of the ancient forms which retains its popularity, but as introducing a new variety it is safe to say that some very clever concealments can be found in almost any familiar quotation. Note how prettily Shakespeare hides an animal when he says:

"All the world's a stage,
And all the men and women merely players."

Or when he conceals two animals in the couplet:

"So we grew together
Like to a double cherry seemingly parted."

And again when he gives the names of two animals, but conceals two more, in the following lines:

"The blood more stirs
To rouse a lion than to start a hare."

Burns went him two better, and concealed two animals, a city and two rivers when he asks:

"Is there, for honest poverty,
That hangs his head and a' that?
The coward slave, we pass him by;
We dare be poor for a' that."

Hood kills two birds with one stone when he says:

"I remember, I remember,
The house where I was born,
The little window where the sun
Came peeping in at morn;
He never came a wink too soon,
Nor brought too long a day;
But now I often wish the night
Had borne my breath away."

Passing over the simple style where a single animal is concealed, as when Cowper says:

"Domestic happiness, thou only bliss
Of paradise that has survived the fall."

Or when Longfellow tells where:
"The shades of night were falling fast
As through an Alpine village past."

Where Moore says:

"How sweet the Echo makes
To music at night . . ."

Or Goldsmith conceals a lone animal:
"That source of all bliss and all my woe,
That found me poor at first, and kept me so."

How Leigh Hunt tells how:

"Jenny kissed me when we met."
We will see how cleverly Longfellow conceals two animals and a town:

"Under a spreading chestnut tree
The village smithy stands;
The smith, a mighty man is he,
With large and sinewy hands,
And the muscles of his brawny arms
Are strong as iron bands."

Or when he says:
"Art is long and time is fleeting
And our hearts, though stout and brave,
Still, like muffled drums, are beating
Funeral marches to the grave."

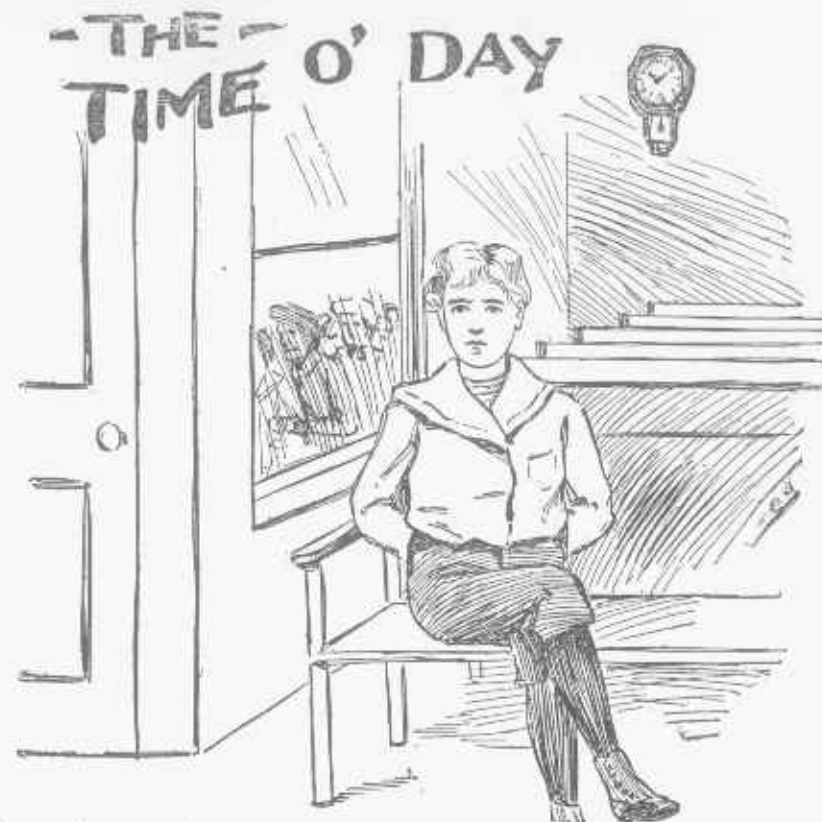

Lover also conceals two animals in the following lines:

"A baby was sleeping,
Its mother was weeping,
For her husband was far on the wild,
raging sea,
And the tempest swelling
'Round the fisherman's dwelling,
And she cried, 'Dermot, darling, oh come
back to me.'"

Taylor tells of a city and two animals when he says:

"From the desert I come to thee,
On a stallion shod with fire,
And the winds are left behind,
By the speed of my desire.
Under the window I stand,
And the midnight hears my cry."

And though you may not believe it, take my word that there is an indefinite number of animals when we are told that:

"Man wants but little here below,
Nor wants that little long."
The palm for cleverness, however, must

be yielded to Wordsworth for concealing at least five animals in a single couplet:

"We meet thee like a pleasant thought
When such are wanted."
He made us the heroes we were not, he left us the cowards we are.

—Rossiter Johnson's "Lawrence."
Some ca' the pleugh, some herd some tentil rin,

I cannie errand to a neeber town.
—Burns' "Cotter's Saturday Night."
How many a tale their music tells.

—Moore's "Evening Bells."
They have builded Him an altar in the evening dews and damps.

—Julia W. Howe's "Battle Hymn."
And O, was it meet that—no requiem read o'er him—

—Scott's "Helvellyn."
Dost thou idly ask to hear
At what gentle seasons
Nymphs relent, when lovers near,
Press the tenderest reasons.
—Bryant's "Song."

SAM LOYD'S AUTOMOBILE PUZZLE



Monsieur de Fole Grass, the noted chauffeur, mentions that while motoring from Passy to Partout, a distance of 136 miles, in two hours, the power steadily diminished during the entire

journey so that the hourly runs decreased a like number of miles each hour. What was the distance recorded by the speedometer at the end of each hour.

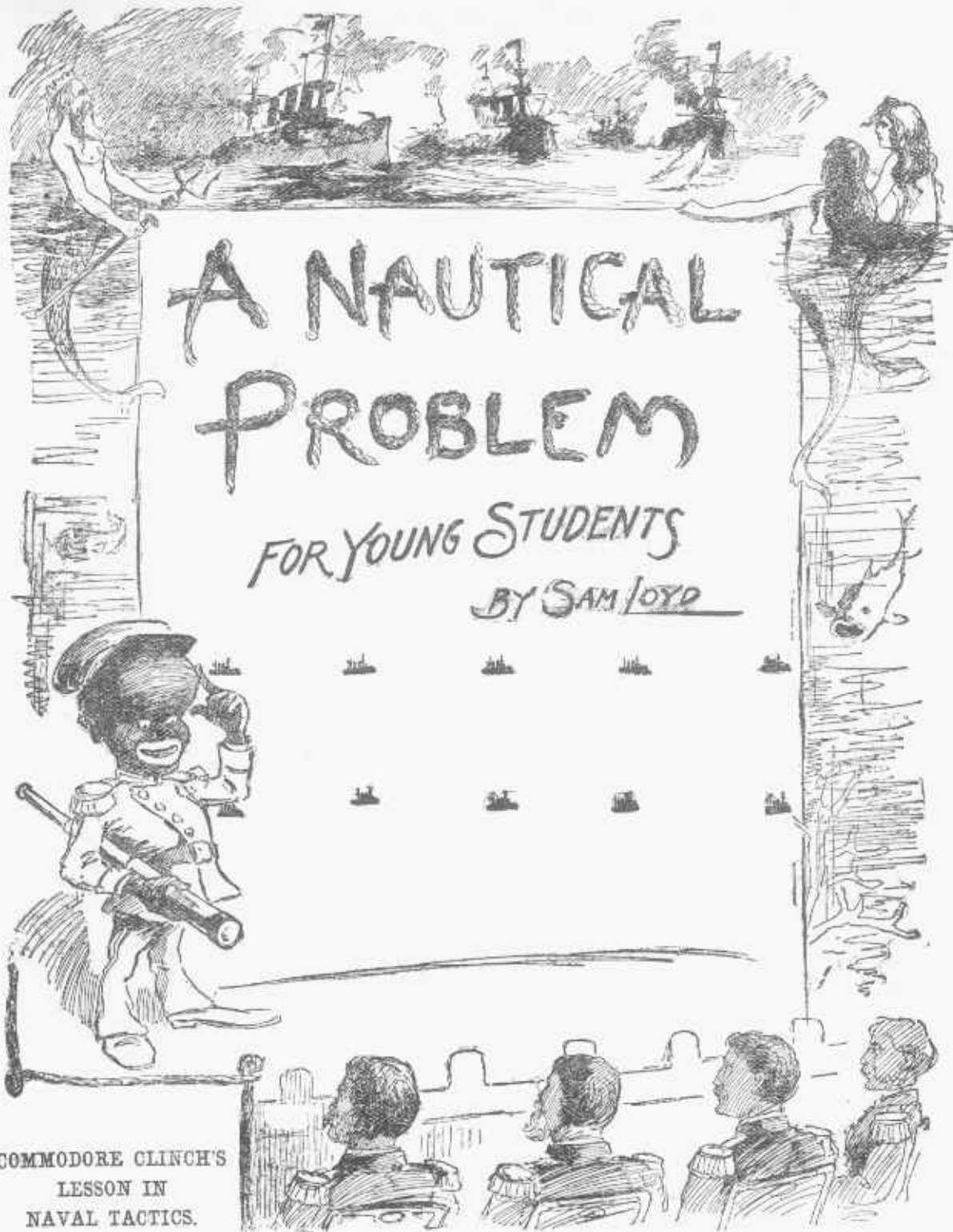

A NAUTICAL PROBLEM

FOR YOUNG STUDENTS
BY SAM LOYD

COMMODORE CLINCH'S
LESSON IN
NAVAL TACTICS.

Here are ten battleships advancing in two rows; upon the approach of the enemy four of the vessels change their positions by the shortest tactics, so that the formation of the fleet will show five rows of four-in-line in each row. How can you perform the feat by only moving four vessels? Ten coins may be used to guess the puzzle.

Guggenheim's Turkey Puzzle.

"There's all the turkeys we have left," said Guggenheim, the market man. "Together they weigh twenty pounds, and the little fellow sells for two cents a pound more than the big bird."
Mrs. Smith bought the little one for eighty-two cents, and Mrs. Brown said two dollars and ninety-six cents for the big turkey.
Can you tell Mrs. Jones how many pounds the big gobbler weighs?



CAN YOU DRAW AN OVAL?

So many correspondents have inquired regarding the correct proportions of an oval for picture frames, table covers, etc., etc., that we here give the rule for making ovals of any desired dimensions. Those who have occasion to use such generally fold a piece of paper and cut it ex-

perimentally, but never get the classically correct eclipse.

Take a sheet of paper, mark a straight line of the desired length, and a cross line of the width, say 15 inches from x to x and 9 from c to z; insert two upright pins on the x x line, $4\frac{1}{2}$ inches from C (being equal to half the length of the desired eclipse), with a temporary pin

at C; pass a string around the three pins as shown. Substitute a pencil point in place of pin C, keeping the string taut while you now describe the oval, letting the string slide on the two pins, and the oval will be a perfect, an eclipse is a symmetrical oval, supposed to represent what is mathematically known as a conic section.

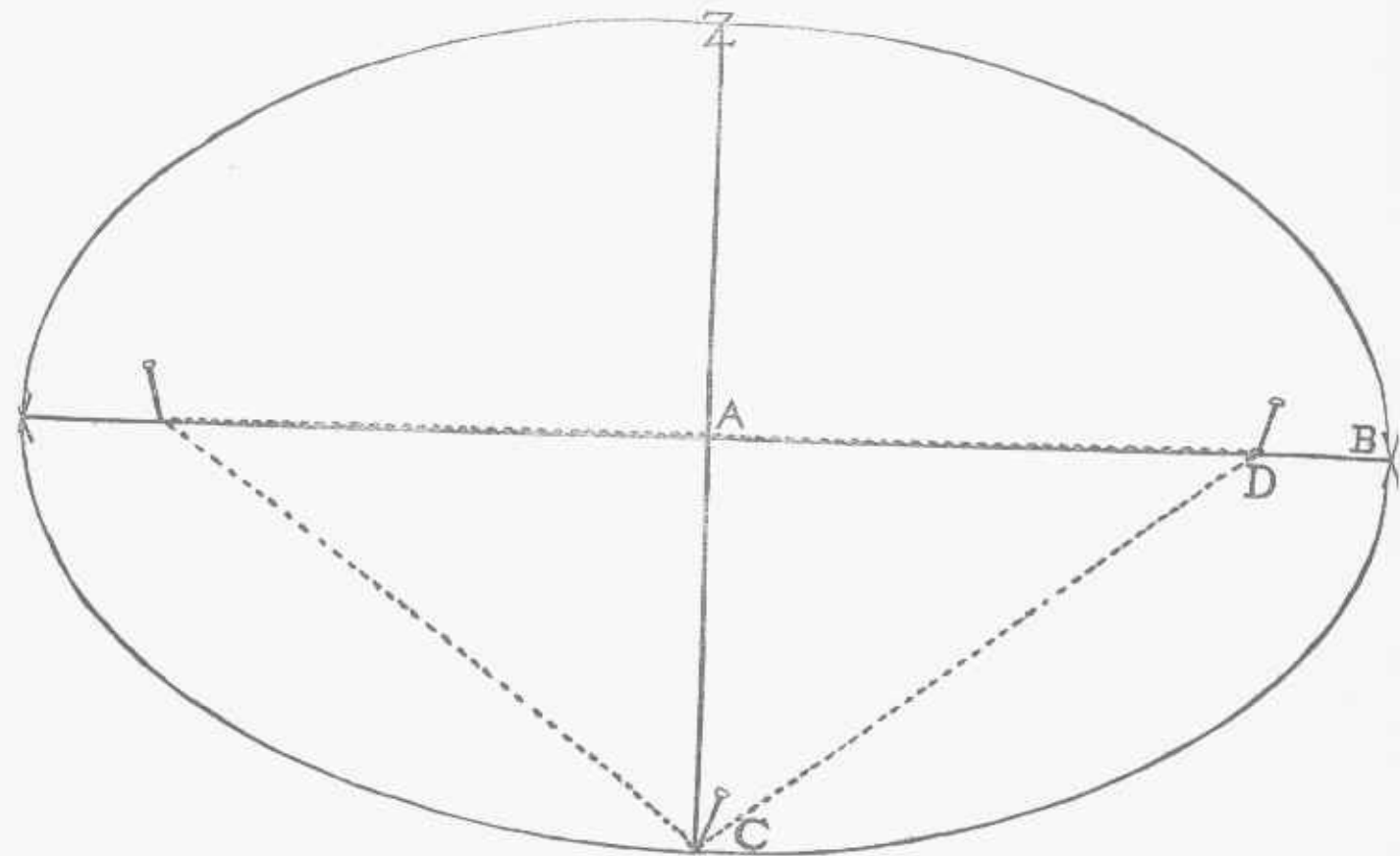

There were two books on a shelf. Vol. I. had 100 leaves, Vol. II. had 150 leaves; if a destructive little book-worm (*Ptinus brunneus*) can bore at the rate of one leaf a minute and through a cover in one hour, how long did it take to bore from the first page of Vol. I. to the past page of Vol. II.?

THRICE BEHEADED.
Untouched I tell of budding growth and life;
Behatted I lead upward more or less;
Again—with varied fragrance I am rife;
Again—but little value I express.

In what does a dog differ from a groom in his treatment of a horse? The dog worries him, the groom curries him; the dog bites him, the groom bites him.

Why is a goat in a bedroom like a house on fire? Both should be put out.

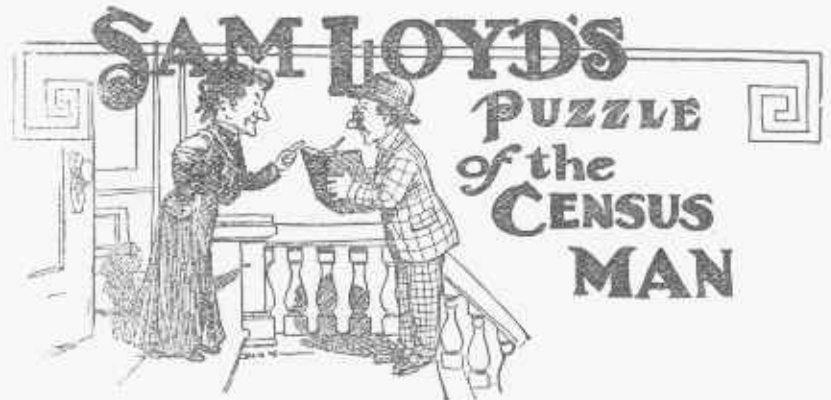

A census canvasser tells of a spinster who, being required to give her age, maintained that she complied with the law by saying:
"If to my age there added be One-half, one-third, and three times three,
Just three score years and ten you'll see.
Which is the age of you and me."

You see, the census man had only to deduct his own age from three score years and ten to know the age of the coy maiden. How extremely simple and pretty!
Why can't they catch a thief who steals a complete harness? He doesn't leave a trace.
When are cooks cruel? When they beat good eggs and whip sweet cream.

SAM LOYD'S WORKSHOP PROBLEMS



THE TRADES UNIONS

I am contracting for the erection of a new **PUZZLER'S HOME** and find that much better terms can be gotten by contracting with the **Allied Trades** than with men individually.

For instance:

The Paper Hanger and Painter

Will Paper and Paint for . . . \$1,100

The Painter and Plumber for . . . 1,700

The Plumber and Electrician for . . . 1,100

The Electrician and Carpenter for . . . 3,300

The Carpenter and Mason for . . . 5,300

The Mason and Paper Hanger for . . . 2,500

What is the cost for each kind of work for erecting the New Home for our Puzzlers?

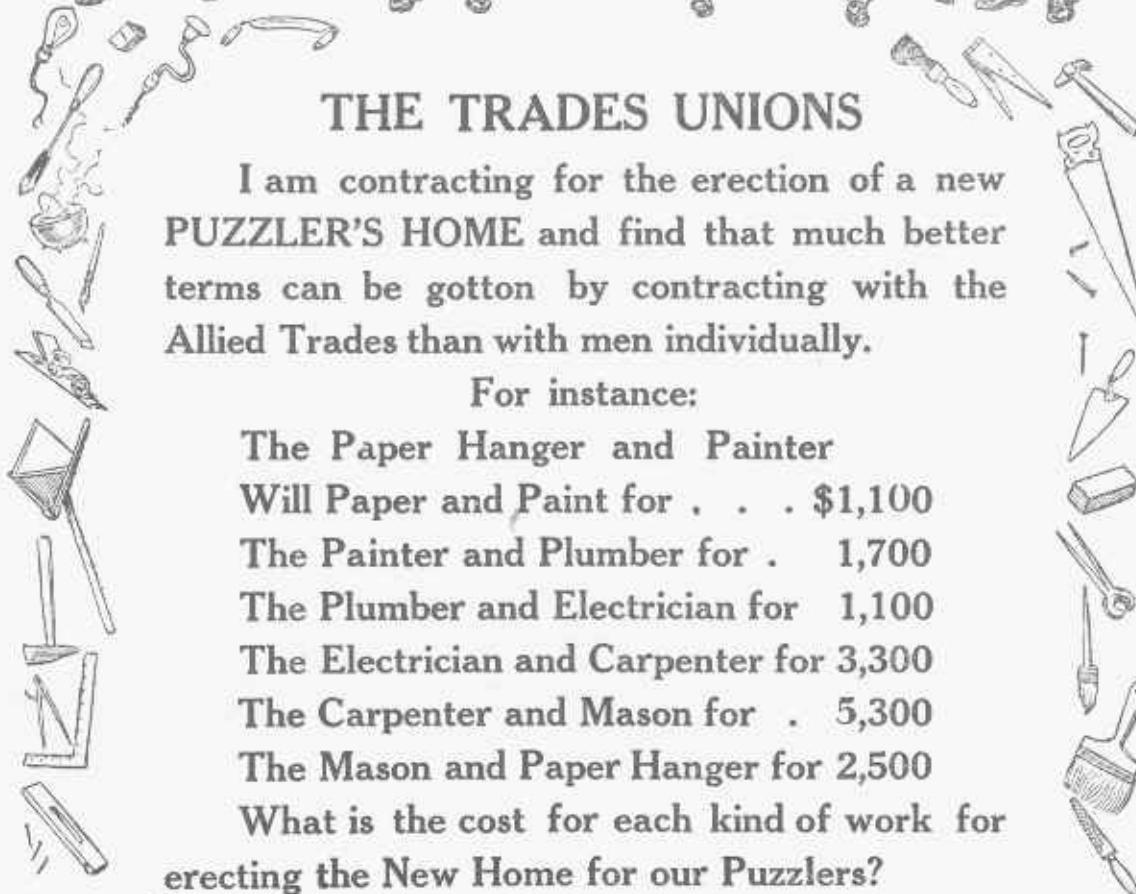

LAWN TENNIS PUZZLE.

The annual competitions for the lawn tennis championship are carried out upon the popular knock-out plan, where the losers retire until by such process of elimination the survival of the fittest is elected to meet last year's champion to battle for the championship. When sixteen players compete and the winner must then play with the old champion, it is evident that he must win five straight games, suggesting the simple problem which has given rise to considerable discussion.

Before commencing play what are the chances of getting the first prize if all are assumed to be of equal strength?

An ex-champion says: "I lost a set the other day, but made 100 points more than my opponent." What was the score?

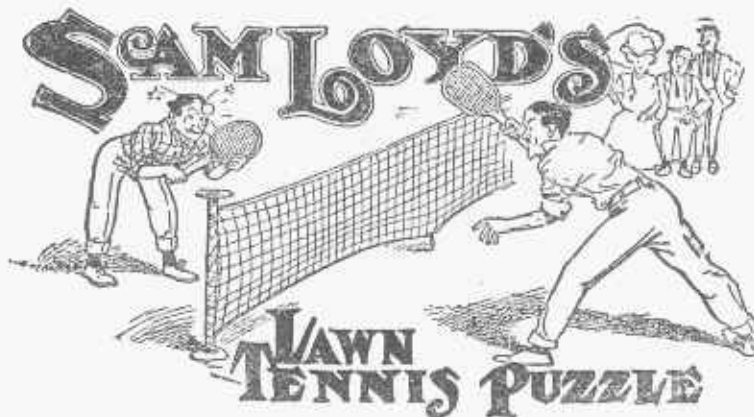

LAWN TENNIS PUZZLE

PAT'S RIDDLE



which, asked the other: "Why was Pat like the man in the picture climbing up the mountain?" Can you tell why?

This is a progressive conundrum, not in the ordinary up-to-date sense in which they speak of smokeless powder, horseless carriages, wireless telegraphy, and the like, and it does not illustrate a phase of armless courtship which never will be popular. I merely mean to intimate that this young couple is making progress and is getting there all right. It was getting late, and Anna asked Pat if he was fond of traveling, and when he responded in the affirmative, she asked him why he didn't travel, and that precipitated things.

Such a broad hint never phased him a little bit. He just looked serious and said, "Yes, I think of going to Cuba very soon." Then she slipped a cog and asked, "Why are you going to Cuba?" and Pat caught her in his arms and exclaimed: "Because I am going to have Anna in a hurry!"

Then one of them, I don't know



Peddler Pete got his accounts all tangled up through the peculiar purchases of an eccentric old lady. First she bought some shoe strings and then four times as many papers of pins, followed by eight times as many handkerchiefs as shoe-strings, pay-

To cater to the tastes of many who revel in a fondness for mathematics pure and simple, as differing from puzzles, an occasional problem of a unique character drawn from the affairs of ordinary life has proved to be acceptable and instructive. Here is one built upon a common, every-day transaction, which every one can understand, whether they know anything about mathematics or not. As a matter of fact, it was suggested and carried out by a man who was so deficient in common arithmetic that he could not compute simple interest and had such a fear of being cheated at figures that he would not make the deal in any other way.

It seems that he wished to buy a piece of property, but having only a small amount to pay down and having an abhorrence of figures, mortgages and interest, said he would not make the purchase unless he could get it upon what he termed the "building loan plan." He would pay down \$1,000 and make five more payments of \$1,000 each at the end of every twelve months. Such payments were to cover the entire cost of the property, including the interest up to the date of each of the five payments.

The sale was made according to the terms stated, but as the money was actually worth just 5 per cent a year to the party who sold, the question is to determine just how much he really got for the property.

ing for each article just as many cents as she bought number of that article. She expended altogether \$3.24 and Peter is puzzled to recall just how many handkerchiefs she must have purchased.



It is said that the modern game of "Craps" is taken from an old dice game of India, wherein a group of natives play for a stake by taking turns in throwing three dice until the winner makes a throw which adds up seven

or eleven.

Can you analyze this old time game by telling what are the chances of throwing three dice so that they add up either seven or eleven?

What is it that Adam never had, never saw, yet left to each of his children? Parents.

What kind of a window resembles a star? Skylight.

Why is No. 9 like a peacock? It is nothing without its tail.

INSTALLMENT PUZZLE.

As showing how the general public fail to apply elementary arithmetic to practical matters, we call attention to the following problem:

A frugal housewife who furnished her little flat with \$75 worth of goods purchased on the popular installment plan wishes to know what interest she really paid for the use of the money. The terms were that she was to pay down \$5 cash and \$3 per month until the goods were paid for; but in case she paid spot cash \$10 would be thrown off, so the articles would cost only \$65.

How many practical people can solve this problem in domestic economy?

Closely akin to the catch problem of the top of the moving wheel is the question of perpetual motion. Any person of mechanical ability should know that the idea of perpetual motion is an absurdly equivalent to inventing a clock which will wind itself.

The following burlesque by Thomas A. Edison has as much sense as any idea yet promulgated. It represents a wheel furnished with eight figures, representing pounds. There will always be a nine opposed to a six and, as nine weighs more than six, it will make the wheel revolve rapidly, as well as your head when you understand it thoroughly.

PERPETUAL MOTION.



THE CATCH PROBLEM OF THE MOVING WHEEL.

I note in a scientific paper that a correspondent seeks for information upon an old problem which has created considerable discussion in the mechanical world, by asking "When a wheel is going on the road does that part of the wheel close to the ground go slower than the opposite side that is free?"

It would be strange that the editor should be caught napping on a problem as old as Samson's lion puzzle, and yet see how cleverly he dodges the issue by giving an answer which, while not responsive to the question asked, is worthy of the Sphinx of Thebes. The reply says: "The rim or tire of the wheel travels faster than the hub, having to make a much larger revolution or circuit in the same time it takes the hub to revolve, but the part of the tire that is on the ground is necessarily travelling at the same rate around its own axis, as that part which is furthest from the ground. If the centre of the earth be regarded as the axis, that part of the wheel which rests upon the ground being nearer the central axis would be slower than the top part, which is further from the central axis. The computation of the difference would depend upon the size of the wheel." Read both the question and answer over several times, so as to compare the information desired with that imparted, and then to complete the missing data assume it to be a 28-inch regulation wheel—riding upon a frozen lake to eliminate all unevenness of the road—and then respond to the query how much faster, if at all, does the top of the wheel go than the bottom?

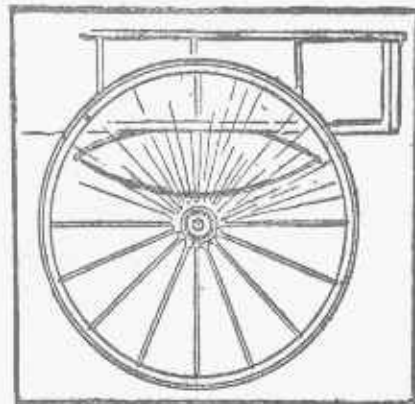

This is a famous problem, which has been discussed seriously by noted scientists and mathematicians, nevertheless it is safe to say that the real point, as intended by the author, has been entirely overlooked. There is just enough of the mathematical and mechanical element in the make-up of the problem to provoke discussions from such as are well-up on these subjects, but the author propounded the question to decide a point of common sense, which seems to have been utterly ignored.

It was evidently perpetrated as a joke, for the top of a wheel progresses exactly as fast as the bottom. If the question referred to a mark on the tire the answer would be different, for the top is the highest point of the wheel and cannot revolve, for if it revolves the hundredths part of an inch it ceases to be the top.

Why do girls blow bubbles better than boys? They are more airy.

SAM LOYD'S INSTALLMENT PUZZLE



THE REMNANT ~ PUZZLE

BY SAM LOYD



DIAMONDS AND CROSSES.

Cut this diamond-shaped piece into three parts which will fit together so as to form a Greek cross.

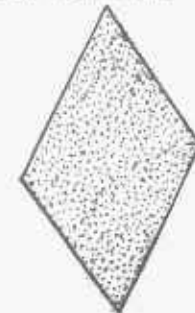

THE REMNANT PUZZLE.

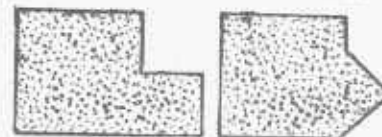

Occasion has been taken to explain the first of these figures to show how any two square-shaped pieces may be cut into three pieces which will fit together so as to form a perfect square. It proves the correctness of Euclid's forty-seventh problem, and is a most valuable rule worth knowing. The Remnant Puzzle is given to show that the same rule applies as well to the combination of squares with triangles to form one large square.

The lady has an odd-shaped remnant which she wishes to cut into three pieces which will form a square without any waste.

The following illustration will show that the triangular piece may also be placed in any position in contact with the square. We have, therefore, four puzzles which illustrate the famous Pons Asinorum, cut any of the four shapes into three pieces which will fit together so as to form a perfect square.



THE TORTOISE AND THE HARE.

Aesop tells of a sportive young hare that raced with a tortoise around a circular track, which was 100 yards in diameter, giving him a start of one-eighth of the distance. The hare held such a poor opinion of the other's ability that he loitered along nibbling the grass, and only realized that the tortoise was putting up a great race when they met at a point when the hare had run but one-sixth of his distance. How much faster than he went before must the hare now run to win the race?

SAM LOYD'S TORTOISE PUZZLE

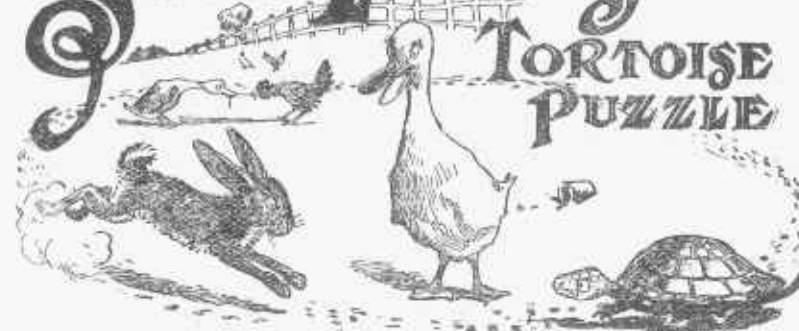

PICTURE SUMS

This Sum Spells Donkey

DON + KEY = DONKEY

What Animal Does This Spell?

BEE - COMB + DOG + LEG + CLOCK = ?

SIMPLE REPETITIONS.

Place a word in the first space of each sentence, which make sense when repeated in the second, even though it may have a different meaning:

1. With the — gave me I — a picture.
2. The mischievous young — over the — flower beds and ruined them.
3. He — minutes to catch the train so he must — or be left.
4. It is almost — to tell the gardener that he must — water.
5. The — brother performed was to catch a — on his nose.
6. His sister — in the hammock saw him — out for a walk.

A CHAPTER OF ACCIDENTS.

Fill in the following dozen spaces with words which have similar endings. Each change is made by the substitution of a single letter.

Mrs. — Jones — in her rocking-chair, pondering over last month's puzzle page, when she was startled by the entrance of a big — which in its desperate efforts to escape dislodged a — from the wall. This so scared the —, which was resting on the — after chasing a — which she was preparing to —, that she fell into a — of hot — and was rescued by —, who exclaimed, "Good gracious, where am —?"

A FISHING EXCURSION.

Name the following score of fishes:

1. A planetary fish.
2. A stamp.
3. To find fault.
4. A lance.
5. A canine.
6. A feline.
7. A sphere.
8. A smear.
9. An explosive.
10. A weapon.
11. A beam of light.
12. Part of the foot.
13. Terms of sale.
14. A kind of tree.
15. A Michigan town.
16. A precious metal.
17. The source of light.
18. A winter pastime.
19. A lineal measure.
20. A color.

27. Remove a letter from a cry and leave a country product; when beheaded again will leave a quantity of paper.

SHAKSPEARE

REBUS PUZZLE



Tommy Muttonhead propounds to his teacher the perplexing query: "If five times six were 33, what would the half of 20 be?" The other pupils solved the problem readily, but

Tommy could not see how a thing that was not what they said it was had anything to do with something else that is not what they say it is.

SAM LOYD'S PERPLEXED PROFESSOR.



REBUS PUZZLES

BEFORE THE YOUNG SOLDIER WENT TO THE WAR, HE SENT THE FOLLOWING MESSAGE TO HIS SWIFTLARE



AND SHE REPLIED



DOUBLE BEHEADINGS AND CURTAILMENTS.

1. Remove the first letter from a word which signifies durable and leave a piece of furniture; behead once more and leave a word that implies skill.
2. Remove the first letter from a building material and leave a musical sound; behead once more and leave a unit.
3. Remove the first letter from a railroad appliance and leave a sorcerer; behead again and produce a disease.
4. Remove the first letter from a solemn pledge and leave a word which signifies to use; behead once more and leave an important organ.
5. Remove the last letter from a word which signifies to gaze, and leave a planet; behead it and leave a sailor.
6. Remove the first letter from a word which pertains to harness, and leave a contest; behead once more and leave a single spot.
7. Remove the first letter from a word which signifies to follow and leave part of a fence; when beheaded once more it will be sick.
8. Remove the first letter from one of a pair and leave a victory, which beheaded again implies contained.
9. Remove the first letter from some grain and create warmth; behead again and learn what to do with the first.

10. Remove the first letters from a word which signifies near and leave a contest; behead once more and you will be not at home.
11. Remove the first letter from an edge and leave a place of amusement; behead once more and you will be able to write with it.
12. Remove the first letter from a piece of furniture and leave a covering for the head; behead once more and leave a tune.
13. Remove the first letter from a cold and leave an elevation which beheaded once more becomes very sick.
14. Remove the first letter from a creeping animal and leave an iron pin; when beheaded once more does not feel well.

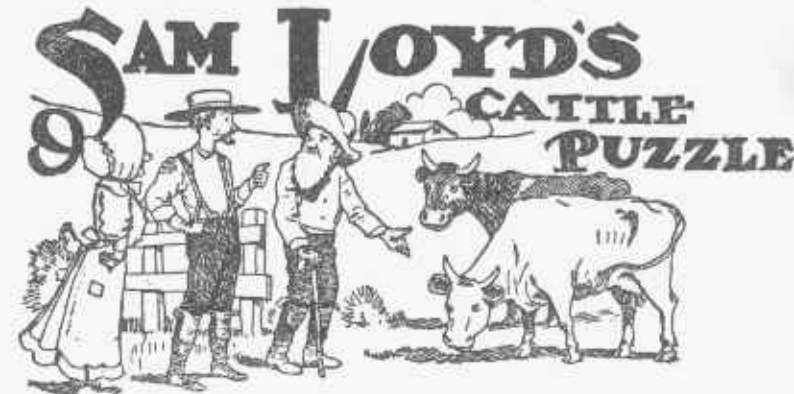

CATTLE PUZZLE.
Farmer Jones sold a pair of cows for \$210. On one he made 10 per cent. and on the other he lost 10 per cent.

15. Remove the first letter from a boy's name and leave a degree; curtail and it tells how he went away.
16. Remove the first letter from a cutting implement and be told to harken; behead once more and learn what you are to give.
17. Remove the first letter from the cost and leave a grain; behead once more and leave something very cold.
18. Remove the first letter from a shallow dish and you will be behind time; behead once more and it will be eaten.
19. Remove the first letter from a position and have some embroidery; behead once more and be one of a pack.
20. Remove the first letter from the beginning and leave a sharp taste; behead once more to learn a profession.
21. Remove the first letter from a melody and leave to educate; behead once more and find a shower.
22. Remove the first letter from vapor and leave a pair; curtail and leave what you want for supper.
23. Remove the first letter from disbursing and find something unfinished; behead once more and you will see the finish.
24. Remove the first letter from a species of stone and find an entrance; behead once more and leave what signifies consumed.
25. Remove the first letter from a word which means to instruct and leave a word which signifies to arrive at; behead once more and we have a word which treats of things separately.

cleaning up just 5 per cent. on his transaction. What did the cows originally cost him?

REBUS PUZZLE

Said the Spring Poet—



And the Editor Sarcastically Replied



GEOGRAPHICAL DROP-LETTER PUZZLES.

1. Take a letter from a town in Tennessee and leave a town in North Carolina.
2. Just drop a letter from a river in New York and leave a word which means to murmur softly.
3. Take a letter from a town in Oregon and leave a wager.
4. Take a letter from a city in Florida and leave a county in Iowa.
5. Take a letter from a river in Mississippi and leave a loud noise.
7. Take a letter from a New York county and leave a flowing garment.
8. Take a letter from a New York town and leave a word which signifies watchfulness.
9. Take a letter from a town in New Jersey and leave a lad.
10. Take a letter from a town in Pennsylvania and leave an animal, or from a county in Pennsylvania and leave an animal.
11. Take a letter from a New York town and leave some vases.
12. Take a letter from a New York town and leave a sound.
13. Take a letter from a Georgia town and leave part of a fish, also from a New York town.
14. Take a letter from a West Virginia town and leave work for a cobbler.
15. Take a letter from a New Jer-

sey town and leave a chain of mountains.

16. Take a letter from a state and leave what belongs to me.
17. Take a letter from an island and leave a young animal.
18. Take a letter from a New York town and leave a wild animal.
19. Take a letter from a foreign country and leave a coin of the realm.
20. Take a letter from a town in

New York and leave Jack Spratt's favorite food.

21. Take a letter away from a foreign country and leave what we all fear.

22. Take a letter away from a town in Massachusetts and leave a transfer of property.

23. Take a letter away from a river in Russia and leave the name of a Russian princess.

24. Take a letter away from a river in Russia and leave the name of a Russian princess.

25. Take a letter away from a county in Pennsylvania and leave a national American delicacy.

26. Take a letter from a Long Island town and leave a landing-place.

27. Take a letter away from a Montana city and leave a girl's name.

28. Take a letter away from a famous river and leave nothing.

29. Take a letter away from a town in North Carolina and leave what Mother Hubbard was unable to find.

30. Take a letter away from a town in New York and leave a bird.

31. Take a letter away from a town in New York and leave a domestic animal.

32. Take a letter from a town in New Hampshire and leave a bird.

33. Take a letter from a state and leave a favorite beverage.

34. Take a letter from a state and leave a native.

35. Take away a letter from a state and leave a reddish color.

POLITICAL PUZZLE

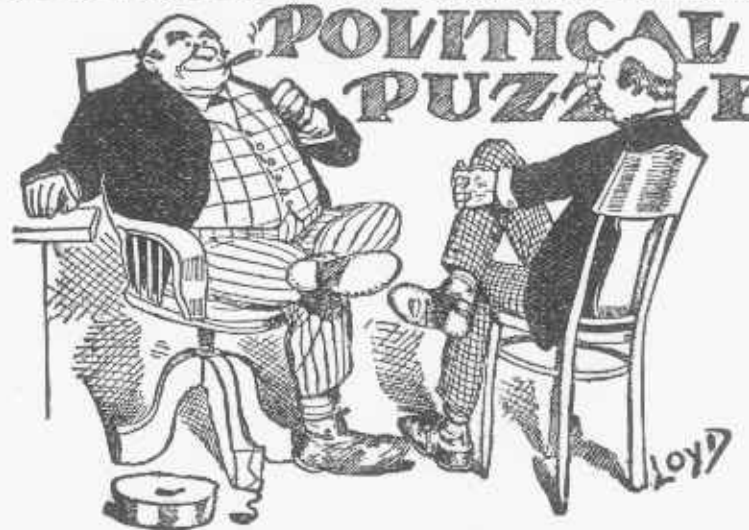

"I spent one-sixth of my years in the old country as a boy," remarked the Boss, "one-twelfth in the liquor business in New York, and one-seventh and five years in politics and matri-

mony, when Jimmy was born. He was elected Alderman four years ago when he was but half my present age." How old was the Boss?

Puzzle Stems

THIS SUM SPELLS CRAB



WHAT ANIMAL DOES THIS SUM SPELL?

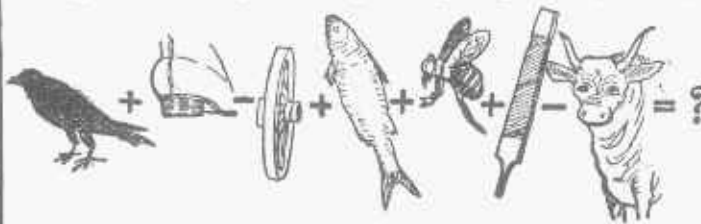

RHYMING BIRDS.

Complete the following verses by inserting the names of well-known birds.

1. Now soaring high, while gazing at the sun,
Or perched upon some cliff, with aspect regal,
Far, far above the range of hunter's gun,
What bird is that? The
2. A Bible tale oft runneth in my head,
Which, on my memory deeply graven,
Tells of a prophet who by birds was fed.
What bird was that? The
3. Wise birds are they "who to the moon complain,"
Of wolf and fox and bears who nightly prowl,
Though rats and mice flee from that bird in vain.
What bird is that? The
4. Black vest, white coat, with collar buff or yellow;
What bird is this, dear scholars?
Can you think?
His song is cheery, light and gay, yet mellow.
Sure, 'tis the
5. What bird so dear, we scarce could do without him?
To build his nest, he seizes cord and bobbin.
His whistling notes enchant the air about him.
You can't mistake the

A SEA SERPENT PUZZLE.

The crop of sea serpents has been unusually large this year, and many new varieties have been seen at the seaside resorts. The yarns of the Nantucket skippers are as thrilling as ever, and for such time-honored theme are remarkably original.

The advent of the kodak, however, has disillusionized the public mind and placed the sea serpent in-

dustry upon a substantial business basis. Exaggerated yarns of the old salts; expert testimony and professionally authenticated log books are no longer accepted unless backed up by a set of pictures taken by members of the amateur kinetoscopers.

A puzzling story of the sea serpent, told on the authority of Captain Hauptman, is that while becalmed off Coney Island he was surrounded by a school of sea serpents. The doughty mariner reports that many of the serpents were blind. He says: "Three could not look from their starboard blinkers; three could not look to larboard. Three could look to starboard, three to larboard; three could look both to starboard and larboard, while three had both their optics out of commission." So it was duly entered on the log-book and duly sworn to that "there were eighteen serpents in sight." But a couple of camera fiends who got a focus on the school of monsters have developed their negatives in a way that negatives the whole story and reduces the number of serpents to the minimum of possibilities, which brings it up to our clever puzzlists to tell just how many serpents belonged to that school?

SHAKSPEARE

REBUS PUZZLE



CAT AND DOG PUZZLE.

Darktown sporting circles are considerably exercised over the outcome of a cat and dog race; about the facts and figures of which no two persons seem to agree. It appears that in a

race of 54 yards from a post to a tree and back to the post, that Sport springs 5 feet at every bound and Tabby only 3, but then she makes 8 jumps to his 5. What should be the result of the race?

SAM LOYD'S CAT AND DOG PUZZLE



PICTURE SUMS

THIS SUM SPELLS PIGEON

FIG + PANE - PAN + BEE + TON - BEET

WHAT ANIMAL DOES THIS SPELL?

neers conspiring to capture their ship. "A risky piece of business," muttered the mate to his pal. "My rank makes this part an easy matter, but the best plan is to bind the captain during his noon nap lest he wake up. He's usually ugly, so hand over the sword on the sofa, then secure the revolver on a shelf by his head. From every passenger we can then exact a large ransom."

SOME MORE DOUBLE DECAPITATIONS.

Showing Five Words Which Are Beheaded Twice.
 To tuneful Warbler's merry —
 Amid cheery sound of meadow —
 His heavy heart accordeth —

"Pshaw," said the silly little —
 What need of making such a —
 If for a moment I peep —

"Why should I fear the angler's —
 I'm not big enough to —
 Nor care to borrow future —"

Why sit so silent on the —
 Give me some music, Birdie —
 On all around the sun's light —
 Is gayly shining —

The gloomy shades of darkness —
 Earth, with a flood of sunshine —
 Finds many a voice to welcome —
 Why then, still pining?

SHAKSPEARE

REBUS PUZZLE



SKATER'S PUZZLE.

It is recorded that in a mile race between two graceful skaters the rivals started from opposite points to skate to the other's place of beginning. With the advantage of a strong wind

Jennie performed the feat two and a half times as quick as Maude, and beat her by six minutes. The problem, which has created no end of discussion, is to tell the time of each in skating *à la* mile.



Puzzle Sums

THIS SUM SPELLS BUFFALO

BAR + MUFF - ARM + BUS + HALO - BUSH

WHAT DOES THIS SUM SPELL?

SIMPLE REPETITIONS.

Place a word in the first space that will make sense when repeated in the second, although it may have a different meaning.

Although the red stockings knew they were — they hardly expected it to — to one defeat.

The — Count informed the family that he was — to form the alliance

FIND YOUR PORTRAIT IN THE MIRROR.

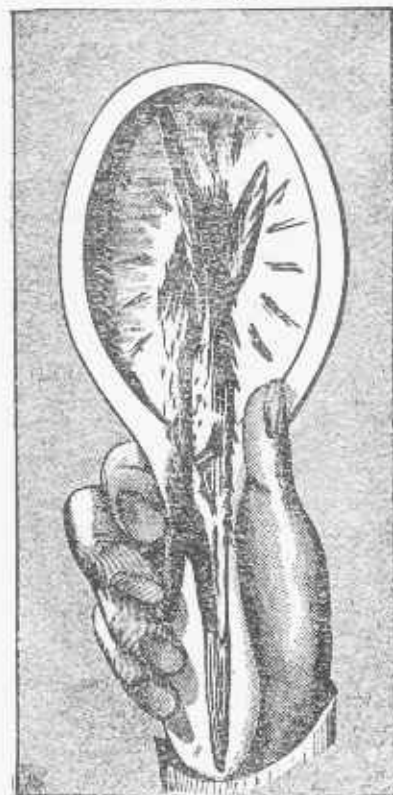

unless he received a proper settlement.

We are — told that not one business venture out — proves to be a success.

The grocer presented me with this large — to give — put in the salad.

Willie wanted his — to go to the country, but ma said they could not go until — a house.

I was not with so small — to make the business a — one.

Unless he could — prejudices, he had no other — than to leave the country.

She, taking the boy's — him away from the toy he so roughly —

He said that he would not — gambling and therefore refused to make — on the game.

The fencers were — to commence — when it was discovered that they had forgotten their masks.

The landlady says it is — to give her boarders a hint that they must — butter.

He said he wished to — cent to help pay his rent, but the scent of his breath was so strong that we told him to —

DOUBLE DECAPITATIONS.

Behead a weapon used in hunting, and leave a fruit; again, and leave what Polonius bade Laertes "give every man." (Hamlet, Act 1, Scene 3.)

Behead to wink drowsily and leave a part of a chain; again, a liquid in universal use.

Behead to upbraid, and leave frigid; again, and leave ancient.

Behead part of an automobile, and leave what is bad to be "out at"; again, and leave certain wriggling animals.

Behead a dangerous sea-monster, and leave to listen; again, and leave a kind of vessel.

Behead a sluggish animal, and leave part of a finger; again, and leave to be indisposed.

Behead calm, and leave to cultivate; again, and leave harm.

Behead that which rolling, "gathers no moss," and leave melody; again, and leave a whole.

A BURIED PROVERB.

In the following lines may be found hidden words which, taken in regular order, will make a familiar proverb:

Yet I see them all! on golden wings that fly
 Old memories steal anew,
 With a tear, with a sigh, with an old, old cry,
 They return in ghostly hue!



CONDUCTOR'S PUZZLE.

"What is the true age of that boy?" asked the conductor. Flattered by the interest shown in his family affairs, the suburban resident replied:

"My son is five times as old as my

daughter, and my wife is five times as old as the son and I am twice as old as my wife, while grandmother, who is as old as all of us put together is celebrating her 81st birthday."

How old was the boy?

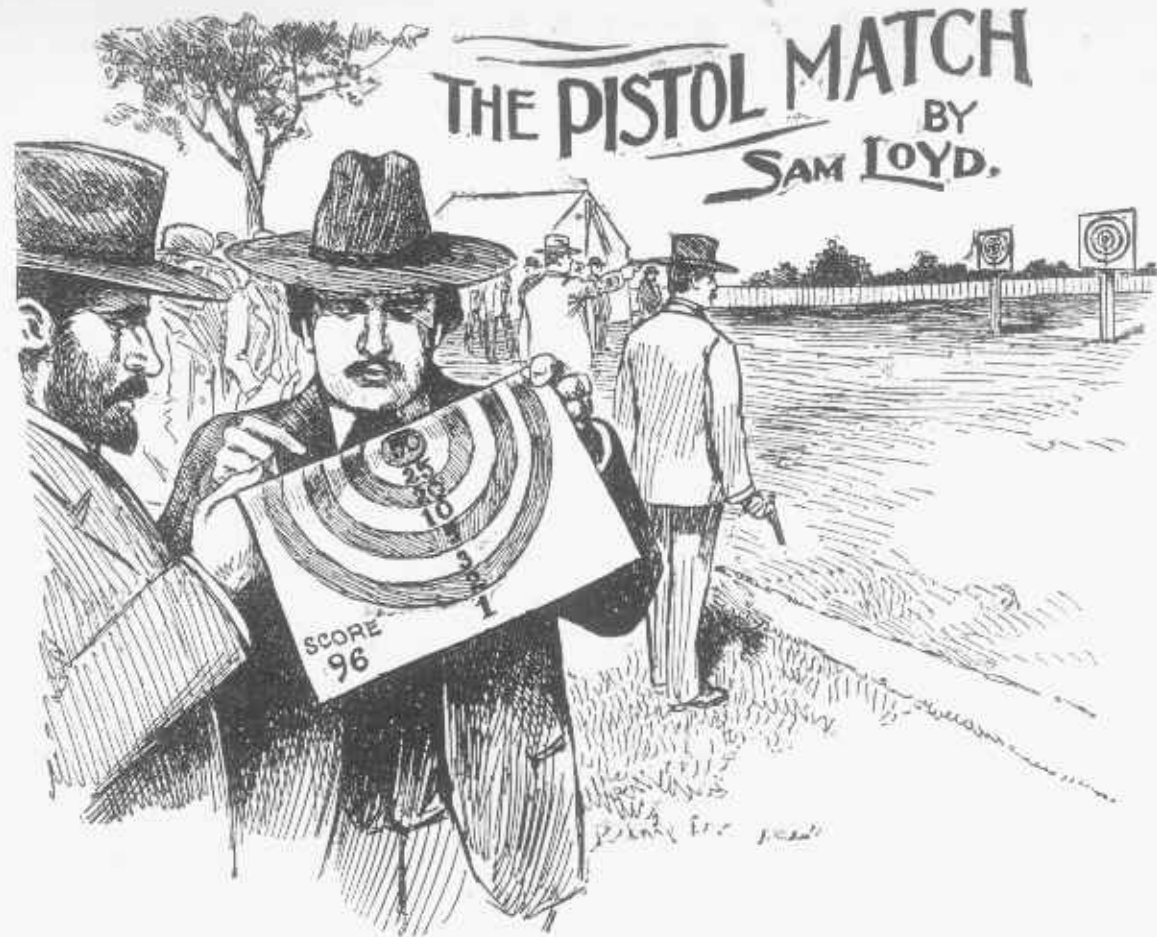

THE PISTOL MATCH BY SAM LOYD.

PROPOSITION—Guess the location of the hits.

AS A VETERAN SHOT who has participated in many matches, I was greatly interested in the recent pistol match by cable, wherein the Americans proved their superiority over the Frenchmen, although it was a pretty close score—4889 to 4821. The shooting took place simultaneously on both sides of the ocean, and the results upon each target were cabled over, which made the match an exciting and interesting one.

I was greatly amused by the comments of the uninitiated spectators, who were greatly mystified by the language of the marksmen who were continually calling out hours of the day strangely at variance with the correct time. Many persons gravely explained that it referred to the difference in time between New York and Paris. "What time did you shoot?" one expert would ask another. "Half past five, but I think I will try half-past four." I tried three o'clock, then four, and I shall now try five o'clock!

The whole point is that it is necessary, on the longer ranges, to make

an allowance for wind and distance, so all marksmen look upon their targets as representing the dial of a clock, so if, when firing straight at the bull's eye the ball hits down where the figure five would be, all he has got to do now is to fire at eleven o'clock to score a "plumb center."

There were some interesting problems developed during the match which I am certain would interest our puzzlists. Here, for instance, is one which struck me as being so pretty that I am sure it will repay one for the trouble of solving it.

One of the marksmen scored 96 with six shots, but it required a close examination to show that he had scored three "doublets," as they term the feat of passing two balls through the same hole.

The targets show the rings scoring from one to fifty points. The puzzle is to name the shots which the umpires are examining, and which make up the score of 96 points.

Why is a pair of skates like an apple? Because they have both occasioned the fall of man.

Why, if a man has a gallery of paintings, may you peek his pockets? Because he has picked-yours (pictures).

How can you get a new set of teeth inserted gratis? Go into somebody else's garden, where they keep a big dog, and kick him.

Where did you go on your tenth birthday? Into your eleventh year.

If Dick's father is Tom's son, what relation is Dick to Tom? Tom is his grandfather.

If Joab was Zeruah's son, what relation was Zeruah to Joab? His mother, his maternal parent.

What is that which lives in winter, dies in summer, and grows with its roots upwards? An icicle.

Why is a professional thief very comfortable? Because he usually takes things so easy.

Why is the food one eats on an ocean steamer like a difficult conundrum? Because we have to give it up.

Why do little birds in their nest agree? For fear of falling out.

Which of the feathered tribe can lift the heaviest weights? The crane.

PUZZLING SCALES



Here is an illustration in kindergarten algebra. On the first scales a pitcher balances with a bottle and a tumbler; on the second scales a bottle balances with one tumbler and a plate. In the third equation two pitchers balance with three plates, which shows that one plate equals two-thirds of a pitcher. In the fourth you are asked to tell how many tumblers it would require to balance with a bottle?

Here we have an illustration of the algebraical axiom that "things equaling the same things equal each other." As the letters x , y , z are always employed to represent the un-

known quantities, we will say that the pitcher equals x , so a plate must equal one-third of x . Now let us add a tumbler on each side of the scales in the second illustration to make the left arm the same as that of the first scales. That proves x (the pitcher) to equal two-thirds of x (the plate) and two tumblers. Then the plate, being two-thirds of x , the two tumblers must weigh the other one-third, so each tumbler represents one-sixth of x . In the first illustration we see one-sixth (a tumbler) and a bottle equal x . Then the bottle must weigh the remaining five-sixths, thus answering the query of

the last illustration by proving that a bottle would balance with five glasses!

A Rebus

With my first do the waters contend,
Or 'tis seen in the pastures so green;
My second brings all to an end
And my whole's oft effected by spleen.
Cipher Answer.—4, 1, 13, 1, 7, 5.

A Charade.

A word of two syllables—what is its name?
Though grapples two things, but one it can claim:
If I be expelled from this little word,
Then lighter than air, ne'er seen, never heard!
Put head to the tail, transferring with care,
This light, floating thing, in sea, earth or air,
Wherever you seek, will always be there.
Cipher Answer.—5, 9, 20, 8, 5, 18.

The following composition was handed to the teacher by a little advocate of reform spelling; it was entitled: "The Grey Cow's Soliloquy in a Barnyard."

Eyebrows awl dey threw loan would oar veil, weighting four Thee son's to raise two Marc Thee our The made whither pale honor Ed. Leeds Thee err dome buy Thee gait.

Can you read it understandingly?



Kitty says to Harry: "Give me one of your pennies and I can buy an apple for baby and one for myself, and you will have just money enough to buy yourself one."
"No," says Harry; "baby hasn't got any teeth and couldn't eat an apple. Give me one of your pennies, and you and I can each get an orange and baby can hear us suck 'em."

How many pennies did the children have?

**ANSWERS TO PUZZLES
GIVEN IN REGULAR ORDER.**

The clown's 47 problem is solved by the rule which produces a right angled triangle from any odd number, viz.: Square it; $47 \times 47 = 2,209$. Divide by 2, and make the hypoth. one greater than the base. Ans.: 47, 1,104 and 1,105. Strange that the fool should have hit upon a dimension to which we can find but one answer in whole numbers. There would have been ten answers if he had said 48 rails. To find a triangle from any even number, square the given number and divide by 4. The quotient will be 1 more than the base and 1 less than the hypoth., viz.: $8 \times 8 = 64$, divided by 4 = 16. So the triangle would be 8, 17 and 19.

I really blush to give the fool's answer to "Why was the blade of that scimeter curved?" It was curved so that it would fit the scabbard!

In the square game mark off 25, 6 and 19 = 50.

In the Iceman puzzle the words are: Soltice, avarice, or artifice, notice, office, edifice, malice, service, choice or prejudice, office, practice, poultice, justice, cornice, lattice, accomplice, vice, dice, rice, surplice, mice, juice, pumice, copice, splice, dentifrice, bodice, price, suffice, caprice, police, advice, device, crevice, and precipice.

The Patchquilt puzzle shows the names: Jule, Lena, Dinah, Edna, Maud, Jennie, Minnie, Anna, Carry, Mary, Nan, Nancy, Jane, Mae, Judy, Hannah and Eva.

Sammy said that chicken was like a farmer because he loved a full crop and measured his corn by the pecks. It was large because it was over two feet. The wings, rear and head of an army. The gas man's bill, The foot, spur and side. The tail. The clause and leg I see. The eye, comb, head, Hen, Biddy, and Hennie. The tows and legs. A base ball player might say it was a foul.

PUZZLE OF CASEY'S COW

As the train goes two bridge lengths, less one foot, while the cow goes half a bridge length, less five feet, and would go three bridge lengths, less three inches, while the cow went half a bridge length, plus four feet, nine inches, we see that the train would go five bridge lengths, less fifteen inches, while the cow went one bridge length, less three inches. So the train goes just five times as fast as the cow, and two

bridge lengths less one foot is equal to two and a half bridge lengths, less twenty-five feet. Hence half a bridge length is twenty-four feet and the whole length is forty-eight feet.

Concealed geography shows: Artois, Smyrna, Nahant, Marblehead, Amherst, Lawrence, Persia, Maderia, Andover, Salem, Roxbury, America, Malta, Pisa, Umbago, Toledo, Utah, Sacramento, Panama and Oahua.

Such of our puzzlists as completed the cross-State run, report that the only possible route by which all of the towns can be visited but once is to take them in the following sequence, according to the designated numbers: Philadelphia to 15, 22, 18, 14, 3, 8, 4, 10, 19, 16, 11, 5, 9, 2, 7, 13, 17, 21, 20, 6, 12 and then to Eric, which completes the trip after having visited the twenty-two towns.

ANSWER TO A BICYCLE MISHAP

In that story from actual experience it was made clear, by giving the facts just as they occurred, so as to appeal to the common sense as well as the mathematical powers of the solvers. It was told that Fred and his best girl started out on a century run one bright morning at 10 o'clock. They went at a five-minute clip and had gone some distance when Fred broke his sprocket wheel in a way which permitted of no temporary repairs. They were compelled to return. He could maintain a three-minute gait on his own wheel, but on her wheel could not do better than three and a half minutes. She could walk, leading the broken wheel, at a speed of a mile in twenty minutes, and he could do the same in fifteen minutes. Everything was favorable, and it was also stated that a new sprocket wheel was ready at home, and could be replaced in ten minutes. Now then, if they left home at 10 A. M., and assuming that they did the best that circumstances permitted, according to the conditions mentioned, and both got home at exactly 6 o'clock, what would their respective cyclometers register if they had gone as far as possible up to the point of the accident?

The accident occurred when he had gone 33 3-17 miles at the speed of five minutes—2h. 45 15-17m.; 33 3-17 miles he returns, at 3 1/2-minute speed—1h. 56 2-17m.; 23 5-17 miles back to meet the lady, 3 1/2-minute speed—1h. 21 9-17 m.; mending wheel, 10m.; 5 miles on his own wheel, at 3-minute gait—15m.; 18

15-17m., 9 15-17 miles walking, 20-minute speed—3h. 17 11-17m.; 23 5-17 miles riding home, five minute speed—1h. 56 8-17m.; total, 8 hours.

Her record—33 3-17 miles to accident, five-minute speed—2h. 45 15-17 miles walking, 20-minute speed—3h. 17 11-17m.; 23 5-17 miles riding home, five-minute speed—1h. 56 8-17 m.; total, 8 hours.

Many overlooked the point that she might ride on while he was fixing his new sprocket wheel, and that the time or distance is not affected by the loss of the ten minutes. Her cyclometer should register 112 16-17 miles, and his but 66 6-17, leaving the matter as to which has done the hardest work and is the most tired an open question.

The hardware store shows the articles: Stovelifters, hammers, nails, bolts, spades, castors, locks, glass, hose.

The cashier gave 5 ones, 50 twos and 19 fives.

If you cut the shafts off close and place on the other side the head will be where it should be:

The proverb says, "it is never too late to mend."

That man seems to be prying.

ANSWER TO TURF PUZZLE

If the odds are 7 to 3 against Apple Pie, then we receive back \$10 for an outlay of \$3; or would get back \$11 for an outlay of \$5 on Bumble Bee. Therefore to balance the book we must place \$27 to \$83 on Cucumber, as proven by the following: \$33 on A would bring \$110, or \$50 on B would bring \$110, and \$27 to \$83 on C would bring \$110. So if you place \$33, \$50 and \$27, which amounts to \$110, no matter which horse wins you just get your \$110 back.

The Swiss flag was constructed as follows:



The signal flag makes a square as shown:

Here is the way to convert the flag into a square:

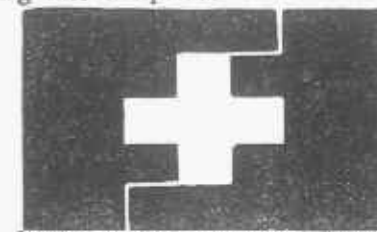

Three squares can be cut into five pieces to make one square; by following the rule given later in the carpentry problems for changing oblongs into squares. It is interesting because all the puzzle books give an impossible answer in seven pieces.



The change of a cross into an oblong is explained in the 1903 Easter puzzle. The cross can be cut on any two of the transverse lines, as shown:



The literary burglars have to guess the word PYX.

Grandfather's query as to the difference in weight between six dozen pounds of feathers and half a dozen dozen pounds of gold, shows that the catch of six dozen dozen being 864, while half a dozen dozen would be but half a gross, does not satisfy the question, because gold is weighed by troy weight, while feathers are weighed by avoirdupois weight. In this case the time honored reply of "A pound is a pound the world over," will not apply.

To be exact, six dozen dozen pounds of feathers weigh 864 pounds avoirdupois, while 72 pounds troy of gold is only equal to 59 pounds 3 ounces and 400 1/2 grains, so the actual difference would be 804 pounds 12 ounces and 30 grains.

The average person has no conception of the relationship between troy and avoirdupois weight. Some believe that the pounds weigh the same, but in one case is divided into sixteen parts and in the other case into twelve to represent ounces. More people, however, believe that the ounces are the same, so that the avoirdupois pound weighs sixteen ounces while the troy pound weighs but twelve. Of course, neither case

is correct, as it will be found that the connecting link between the two systems turns upon the fact that a pound avoirdupois weighs 7,000 grains, while a pound troy weighs only 5,760 grains.

In presenting the answer to the Pony Puzzle, Mr. Loyd takes occasion to point out the fact of the black pieces of paper being nothing but a delusion and a snare. The pieces are to be placed so as to make the representation of a little white horse in the center as shown.

It was this trick of the white horse of Uppington which popularized the slang expression: "Oh, but that is a horse of another color!"



The boardinghouse pie can be cut into 22 pieces, as shown. The letters show how Aunt Mary marked her pies so as to tell whether 'tis mince or 'taint mince:



ANSWER TO THE CAT AND DOG RACE

In Barnum's great puzzle it was said that "A trained cat and dog run a race 100 feet straightaway and return. The dog leaps three feet at each bound and the cat two feet. The she makes three leaps to the dog's two," and the puzzle was to tell what were the possibilities of the race.

Now, the cat wins, of course. It has to make precisely 100 leaps to complete the distance and return. The dog, on the contrary, is compelled to go 102 feet and back. Its thirty-third leap takes it to the 99-foot mark and so another leap, car-

rying it two feet beyond the mark becomes necessary. In all, the dog must make 88 leaps to go the distance. But it jumps only two-thirds as quickly as the cat, so that while the cat is making 100 leaps the dog cannot make quite 87.

But the puzzle turns upon the possibilities of the race, just let us suppose that the cat is a Sir Thomas cat and the dog Blanche is one referred to as she. Then the possibilities which Barnum had up his sleeve would read: "A cat and a dog run a 100-foot straight away race and return. The dog makes three leaps to the cat's two." So the dog really goes 9 feet to the cat's 4. As the dog finishes the race in 88 leaps, the cat will have gone but 90 feet and 8 inches.

That study in division was solved by a little boy No. 6.

Standing on his head so that the number 981 was divisible by 7.

The astronomical puzzle solves by 14 straight lines.

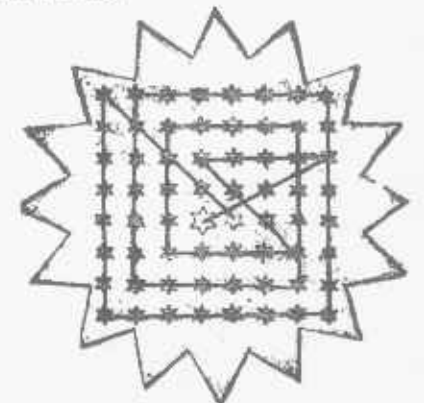

That lesson in military tactics, wherein a military division was to enter the park at one gate, go through the sixty four squares and out at the other gate after passing under the triumphal arch in the center of the field, was sufficiently difficult to amuse and interest our young puzzlists, who found that there was but one way to perform the feat in fifteen moves, as shown, although there are a thousand and one routes which call for just one extra turn.

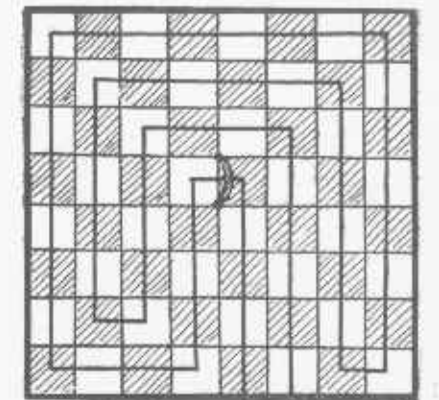

Paddy's Pig made 14 turns, as shown:

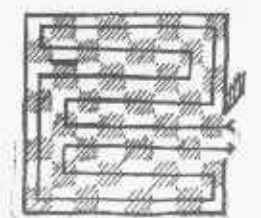

ANSWER TO THE ROGUE'S LETTER

In that study of hidden cities we find the following familiar places in their regular order: Cleveland, Baltimore, Raleigh, Dallas, Omaha, Macon, Utica, Winona, Norwalk, Andover, Dover, Derby, York, Thebes, Reading, Rome, Early, Dayton, Lowell and Ellsworth.

Charade: Metaphysician.

SOLUTION TO CONVENTION PUZZLE

There were 147 votes cast. On the first count the affirmative vote was found to be to the negative vote as 4 to 3, but when eleven votes were transferred from the affirmative to the negative, the negative had a majority of one. This shows that 21 was one-seventh of the whole number of votes.

WHAT HAPPENED

In this rollicsome picture of the elephant and the mischievous boy it was required to cut the picture into two pieces which would fit together so as to show what happened when the chain broke. The following illustration describes the scene very aptly:



The monkey went from 10, 11, 12, 8, 4, 3, 7, 6, 2, 1, 5 and 9, as that route travels the wide spaces but twice.

The rebus arithmetic reads: Cow +heel+women, less wheel, less cow, which would leave O.

In the story of the great parade it was told that when the men attempted to march with any number of men—from two to ten—in a row, there was always a vacant space left where Casey used to walk. Now all of our young puzzlists know how to find the least common multiple of 2, 3, 4, 5, 6, 7, 8, 9 and 10, but that vacancy of one puzzles them, because it took them away from the rules of their books. Nevertheless, it is plain arithmetic and yields readily to a little reasoning, 2520 is the least common multiple of 2, 3, 4, 5, 6, 7, 8, 9 and 10, and may be divided by any of those numbers, hence that must have been the original number of members, when Casey was alive. Take away the one man and attempt to arrange the parade with any number of men from 2 to 10 abreast, and it is plain to be seen that the last row will always be short just one man, so it is obvious that the correct answer would be 2,519 men if it were not for that puzzle catch where it said: "As eleven would not do." For 2,519 men could be divided by 11, so we will have to give 5039 as the correct number of men who could not be divided into rows from 2 to 11.

The Monad puzzle is cut into four pieces by the curved line as shown, whereas a straight cut from A to B would give 4 pieces of same size but different shapes. The horse shoes may be divided into four pieces which will fit together so as to make a perfect monad.



Charade: Mama or papa.

SOLUTION TO LAUNDRY PUZZLE

It can be seen that if there were thirty pieces of laundry and Freddie was charged 27 cents for half the cuffs and one-third of the collars, there must have been 12 cuffs and 18 collars, so Charlie will owe 39 cents, as collars cost 2 cents and cuffs 2½ cents.

The Smart Alec puzzle, as was intimated, proved to be a difficult task to master by purely experimental methods, although, as was explained, a knowledge of Pythagoras' prob-

lem is of use in discovering the answer.

Pythagoras' rule will give us at least the size of the square to be formed, for if we divide the paper into four pieces by cutting in the dotted lines, we know that 2 and 4 will make one square, while 1 and 3 will form a smaller one. Placing the two squares together, according to the manner explained some time ago, the hypotenuse line from the corner X to the top of the smaller square at Y gives the size of the new square.

To solve the puzzle, however, in the fewest possible number of pieces, first clip off the little pieces 1 and 2 and pack them into the center. Then cut the zig-zag steps, and move the piece No. 4 down one step and the four pieces fit together so as to make a perfect square. There are numerous ways of performing the feat with from five to a dozen pieces, but the answer as given is both difficult and scientific.

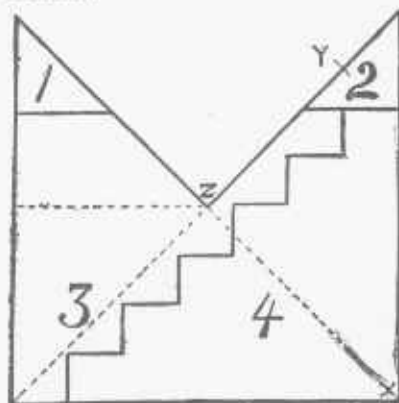

The Quarrelsome Neighbors made their paths as shown in the accompanying sketch:



What did the bear want? Why, as he was in a dry goods store, he wanted muslin!

The players who all won were fiddlers in the German band and gained \$5 per night. I did not intimate they were card players.

ANSWERS TO LABELS AND TRADE-MARKS

All of the pictorial rebusses contained in that odd collection of labels from the corner grocery were mastered by our clever puzzlists, although some of them proved to be

pretty hard nuts to crack. The following are the words given in their regular order: Cab-ages, Beets, Berries, Tar, Borax, Time and Sage, Tom eight o's, Black king, Pears, Rays Inn's, Turn ups, Coal and wood, Teas and Condensed Milk, Dates, Butter, Candies, Candles, Canned Peas, Pickles, Mat chess, Cat sup, Flour, Molasses, Indian and Rhyme eels, Farina, and Carpet tacks.

THE REBUS PUZZLE

In the sketch of the two parrots which are supposed to represent the motto of a tea store a clever reading of the situation will discover that "ON ST is the best poll I see," or, as the merchant would say, "Honest tea is the best policy."

In the first of the Time Puzzles the watches must have started at 45 minutes and 25 seconds past midnight, and as the fastest gets three minutes ahead of the other every hour, it would be one hour ahead in 20 hours; it is therefore 20 minutes ahead of correct time, while the other is 8.45m. 25 sec.

In the proposition: How soon will the hour, minute and second hands again appear the same distance apart? Hold the picture before a mirror and it will indicate the time at which it will arrive in exactly 6 hrs., 10 min., 50 secs. The second hand occurs midway between the hour and minute hands 1,427 times every 12 hours (43,200 seconds), viz.: Every 30 seconds as the constant, which gives the position on the dial as the nearest possible tri-section.

A pendulum 52.02981 inches long will vibrate 52.02981 times in a minute. If you can't figure it out, take my word for its correctness.

The Butcher Boy problem is authentic in every detail. Butcher Boy cost \$220, sold at 12 per cent. loss=\$198. The other horse cost \$264, sold at 10 per cent. profit=\$295.68. Total, \$484; received \$493.68, which shows 2 per cent. profit on the whole.

The mystery of the Gold Brick is mathematically explained by saying that the new form is really 25x25 1-23, which still contains 576 square inches.

The Hindoo puzzle forms the cross as follows:



It is apparent from the struggles that the infant "cannot go a step farther."

The Bottled letter shows that Noah must have been the writer.

The cheese is divided in two pieces by one cut, into 4 by the second; 8 by the third; 15 by the fourth; 26 by the fifth, and 42 by the sixth.

The Japanese Mines may be crossed by two straight lines as shown:

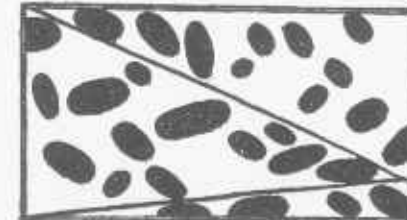

In the Puzzleland Patchquilt we find the names of Hannah, Etta, Tesse, Amos, Moses, James, Josh, Sam, Mose, Otto, Frank, Hanks, Harry, Thomas, Hope, Joseph, Jesse, Seth, Hart, Henry, Mat, Nate, Nathon, Aesop, Earnest, Anna, Ann, Anne, Emma and Jose.

The Cipher despatch says: Let us suppose that Charles is one-third richer than Ellen, then how much poorer is Ellen than Charles? The answer to which is that Ellen is one-fourth poorer than Charles.

SOLUTION TO WEARY WILLIE AND TIRED TIM PUZZLE

The information gleaned from Weary Willie's diary proves that the distance between Joytown and Pleasantville is 18 miles.

The answer to this problem may be obtained by simple addition, subtraction, and a little common sense, as follows:

When they met for the first time, Weary Willie had gone ten miles from Joytown, while their combined journeys equaled the distance between the two towns.

Meeting for the second time, their combined journeys equaled three times the distance between the towns.

Weary Willie, who had gone ten miles at their first meeting, by the same ratio must have traveled 30 miles when they met for the second

time. Weary Willie walked ten miles from Joytown and met Tim; then he went the distance from that signpost to Pleasantville.

Back he came 12 miles from Pleasantville to the signpost in the second picture.

We have proved that he went altogether 30 miles. Also that he went 10 miles, 12 miles and the distance from the signpost in the first picture to Pleasantville.

That unknown stretch we may now ascertain by deducting 22 miles from 30 miles, giving 8 miles as the distance Willie had to go to complete his trip to Pleasantville, after he had gone 10 miles.

Therefore, the distance between the towns must be 18 miles.

The question of which is Willie and which is Tim cannot be answered from the picture, but we may christen them as we like without affecting the puzzle.

The Pictorial Charade reads: "Horses to let or for sale."

Pat's pig sty puzzled many clever mathematicians as well as puzzlists who failed to place twenty-one pigs in four pens so that there will be an odd number of pigs within each pen, as well as an even number of pairs. Clever puzzlists hit upon the necessary expedient of "nesting" the pens one inside of another, but the feature of saying that each pen must contain "an equal number of pairs," as well as the fact of the outside pen, which is in sight, holding not less than five pigs which can be seen, spoiled some of the answers suggested.

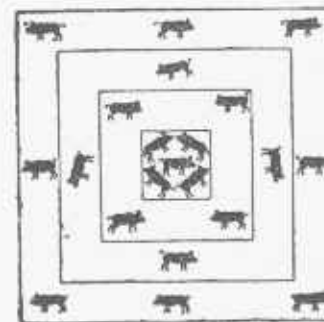

The only possible answer is to place five pigs in the center pen, viz.: two pairs and an odd pig. Then build a pen round that pen and place four pigs in it, a third pen surrounds that one, also with four pigs, and the fifth pen with eight pigs incloses the other pens, and as a matter of fact contains the entire twenty-one pigs!

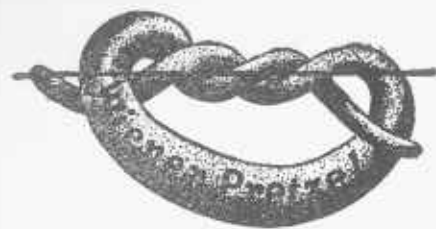

The Pretzel can be divided into ten pieces as shown:

Duck shooting at Buzzard's Bay is solved by changing the position of two ducks, as shown, which gives five rows of four-in-line and places one duck in Grover's game bag:



ANSWER TO PATCH QUILT PUZZLE

The following diagram shows how the 13x13 quilt can be divided into eleven smaller squares, which is the least number of square pieces which it will divide into without destroying the checkered pattern. It proved to be a difficult puzzle, and those who discovered the correct answer, found that there was a certain mathematical principle involved, which held them close to the rules of square root.

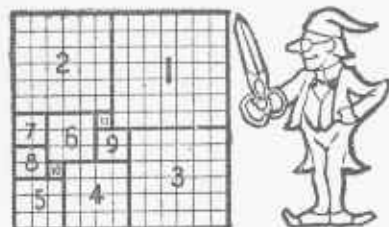

ANSWER TO THE APPLE WOMEN'S MISSING PENNIES

To tackle the problem from a somewhat new standpoint it can readily be shown that the apples, if sold at 1-3 of a penny and 1-2 of a penny, would average 5-6 for two, or 25-60 of a penny for each apple, but as they were closed out at the rate of five apples for two pence, which is the same as 2-5 or 24-60 of a penny per apple, then 1-60 of a penny was lost on every apple. As it was stated that seven pence was lost, we will multiply that 60 by 7, which shows there must have been 420 apples, of which they each had

one-half. As Mrs. Jones had 210, for which she would have received 105 pence, but only got one-half of the proceeds of the entire sale at the rate of 5 for 2 pence, viz.: 84 pence, she lost twenty-one pence, while Mrs. Smith, who should have received but seventy pence for her three-for-a-penny fruit, actually gets eighty-five.

The mysterious discrepancy occurs at the end of the seventieth combination sale. Mrs. Smith's cheap fruit becomes exhausted on the seventieth sale, which takes 210 of three-fors, and 140 of the two-fors, and at that stage of the game Mrs. Smith was entitled to half of the proceeds, and should have withdrawn with her seventy pence. As there were now just seventy of the better class stock left, every sale now involves the giving of three apples for a penny, which should sell for two for a penny, Mrs. Jones' stock is sacrificed.

ANSWER TO A, B, C, PUZZLE

Our sharp young puzzlists correctly surmised that the half dozen letters which did not come to supper were U, V, W, X, Y and Z, because they come after T.

Into the second proposition, change the M into Y and you spell the word cayenne. The second block represents the island "Cuba A."

ANSWER TO THE SWARM OF BEES

The eight good resolutions which the clever young miss drafted for the new year will be found to consist of always being "be backward in nothing, be wise, be independent, be benign, be on time, be honest, and be behindhand in nothing."

AFTER DINNER TRICK

That odd little sleight-of-hand performance with the four empty and four full glasses can readily be remembered by the following rule: First, why one long move, then two short ones and then one long one, viz.: First move 2 and 3 to the extreme end; then fill the gap with 5 and 6. Fill gap with 8 and 2; then finish with 1 and 5. Counting the original numbers of the glasses.

Decapitation puzzle: Shark.

Animals enigmatically expressed: Beaver, Camelion, Glutton, Pole cat, Marten, Goat, Antelope.

REMARKABLE KLONDIKE YARNS

Everybody, including their cousins, uncles and aunts, caught on to the spirit of one or more of those Klondike yarns, and gave reasons

for selecting one of the most remarkable of the three. As was surmised, however, while many discovered one of the catches, very few hit upon two, so, according to the theory of chances, the probability of any one person catching on to all three of the points was so remote that there were only a few left to the final sifting.

The winners all selected the first story as being remarkably beyond all belief. Just imagine that three-year-old infant eating forty-eight pigs' feet in the cause of science! He had already devoured "four pigs' feet" (not "four pig's feet"), and then tackled twice as many more (32 more) just to satisfy his mind regarding the truth or fallacy of the existence of a "bogey man."

There was really nothing in the other stories which gives evidence of extraordinary intelligence or which should excite our surprise. A stupid child which had been told that there were exactly two pints to a quart said that the water which ran over the Falls of Niagara in a month was also exactly two pints to a quart. Nothing, of course, could be more natural that that a deaf and dumb babe should say absolutely nothing, so the first yarn was the only remarkable "whopper" which would bring a blush to the cheek of Baron Munchausen.

ANSWER TO SANTA CLAUS PUZZLE

In that capacious pack in which were stored so many toys which were supposed to represent the parts of a chopped-up person, we begin at the top with a watch and discover hands and face, teeth, caps, hair, calves, locks, arms, palms, limbs, two lips, two feet, chest, nails, side, drum, cords, veins, pupils, heart, bridge, soles, temple, column, ears, corns, tongue, body, skull, blade, lash, lights, gums and windpipe.

Lewis Carroll's monkey puzzle is about as paradoxical as a recent conundrum which is going the rounds, as to what is it that will go down a chimney down, but will not go up a chimney up? (Umbrella.) There are three possible consequences to select from in the monkey problem: The progress of climbing might have no effect whatever upon the equilibrium; it might cause the weight to fall, which would raise the monkey quicker than he wished, or it might

raise the weight, which would be apt to give the monkey a tumble. From the standpoint of a guess, pure and simple, opinions were about evenly divided, so two out of three were wrong in their conclusions.

From a theoretical and scientific point of view it is just as paradoxical as the ambrella conundrum, for if the monkey goes up he will go down, whereas if he goes down he will go up. The argument is based on Newton's law that "action is equal to reaction." The engine which moves a train is pulling itself along by the rails. Theoretically speaking, if there was no friction, a fly could not crawl up that rope without destroying the equilibrium, so that the rope would be drawn over the pulley and the monkey end fall by a rapidly increasing momentum.

ANSWER TO THE EASTER PUZZLE

The following illustration shows the manner of dividing the Greek cross into three pieces which can be fitted together so as to form a rectangle twice as long as it is wide. The reversing of the proposition to the dividing of an oblong into a Greek cross would be more difficult, as no inking of the angles to be fitted together is given.

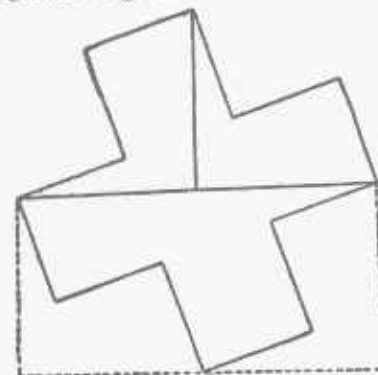

The Swastica puzzle may be cut and squared as follows:

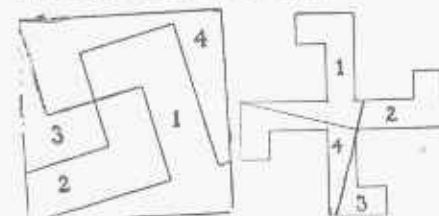

THE CONCEALED LOCATION OF THE BOLD RIDER IS DALLAS

Anagram puzzle: Punishment. Numerical enigma: Much ado about nothing.

Evolution Puzzles. Lands, hands, hinds, hints, hilts, hills. Beer, bees, Ben's, bins, wins,

wine. Shoe, shot, soot, boot, North, forth, forts, torts, toots, tooth, sooth, south.

In the puzzle of the pasture field it becomes necessary to figure upon the daily growth of grass. We were told that the cow eats as much as the goat and the goose. Therefore, if the cow and goat eat the stock of standing grass added to 45 days' growth in 45 days, it is plain that 2 goats and a goose would take the same time. As a goat and goose would be twice as long, we see that one goat would take 90 days, and that the goose could just keep up with the growing grass. Therefore, if the cow eats 1-60 of the stock per day, and the goat 1-90, together they would eat 1-36. The answer is that the cow and goat would eat up the standing crop in 36 days, while the goose devotes the same time to taking care of the daily growth.

In giving the answers to the necklace puzzle it may be said that any jeweler, as well as ninety-nine out of a hundred mathematicians, would say that to solve the necklace puzzle would be to open the smaller links at the ends of the twelve pieces, which, it may readily be seen, would reduce the cost to \$1.80. The correct answer, however, is arrived at by opening the ten links on those two small five-link pieces, on the right and left sides, which have three small and two large links each. To open and mend those ten links so as to bring the chain into an endless necklace would cost just \$1.70, which is the cheapest possible answer.

Rebus: Fund.

Mrs. Johnsing's laconic reply was: "Eight."

Hipity-Hop could go one mile up the hill in 40 minutes, and could come down a mile in 13 1/2 minutes. Therefore he would average a mile up and down in 53 1/2 minutes. Since the particular hill which he tells about required six hours to climb and descend, we may determine its height by dividing six hours by 53 1/2 minutes. Thus we learn that hill must have been six and three-quarter miles high.

Charade: Mated.

The florist had a 50-cent piece and a 25-cent piece. They pooled all their money, then the florist takes the \$1. the 5 and two 2-cent pieces; the lady the 50, 10, 10

and 1, and the boy 25 and 3, which gives each their proper change.

There would be many answers to the problem of playing the races were it not for the fact of fractional parts of a dollar being contrary to the rules of the turfites, so the only amounts which satisfy the conditions of the problem are that each lad had \$2. Jim bet 15 at 15 to 1 straight, and won \$225, which with his original \$25 equals \$250. Jack bet \$10 at 10 to 1, for second place, and won \$100, which with his \$25, equals \$125; so he has just half as much as Jim. Algebraically expressed the problem is simply 2 [a sq. plus e plus b] equals b sq. plus b plus a.

ANSWER TO THE CARPENTER'S PUZZLE

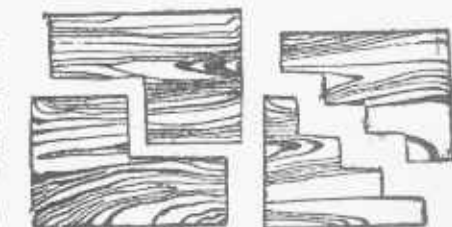

The amount to be distributed each week was 120 shillings. This divided among twenty persons gave 6 shillings to each. If there had been only fifteen persons they would have got 8 shillings apiece, but when twenty-four came the share of each was only 5 shillings.

ANSWER TO MILKMAN'S PUZZLE

Let us call one of the ten-gallon cans A and the other B, and proceed as follows to show how the milkman supplied his two customers with two quarts each:

Fill 5 qt. pail from can A.
Pour 5 qt. pail into 4 qt. pail.
Empty 4 qt. pail into can A.
Pour 5 qt. pail into 4 qt. pail.
Fill 5 qt. pail from can A.
Fill 4 qt. pail from 5 qt. pail.
Empty 4 qt. pail into can A.
Fill 4 qt. pail from can B.
Pour 4 qt. pail into can A.
which fills can A, leaving 2 quarts in 4 qt. pail. Thus the milkman has supplied each of his customers with exactly two quarts of milk, and solved his perplexing problem.

Charade: Potatoes.

In the matter of dividing the O'Shaugnessy estate, it being clear that it was designed to give the

mother twice as much as the daughter, and the son twice as much as the mother, it becomes a simple matter to carry out the terms of the bequest by giving the daughter one-seventh, the mother two-sevenths and the son four-sevenths.

That vinegar merchant sold the 13 and 15 gal. kegs of oil at 50 cents per gal.—\$14. He also sold 8, 17 and 31 gals. of vinegar at 25 cents = \$14. So he had the 19 gal. barrel left, which was worth \$4.75, or \$9.50, according to whether it contained vinegar or oil.

Charade: Ciphers.

Mary's age problem shows that she was once three times as old as Ann, so let us try 12 to 4, which shows a difference of 11 years, so, if their combined ages amount to 44, Ann is 16 yrs. 6 mos. to Mary's 27 yrs. 6 mos. Mary being twice as old as Ann was (13.9) when Mary was (24.9) half as old as Ann will be when she is (49.6) three times as old as Mary was when Mary was three times as old as Ann!

When Miss Carrie Wait had her falling out she must have weighed 120 lbs. as the following 12 cords of the hammock broke as shown in the accompanying illustration

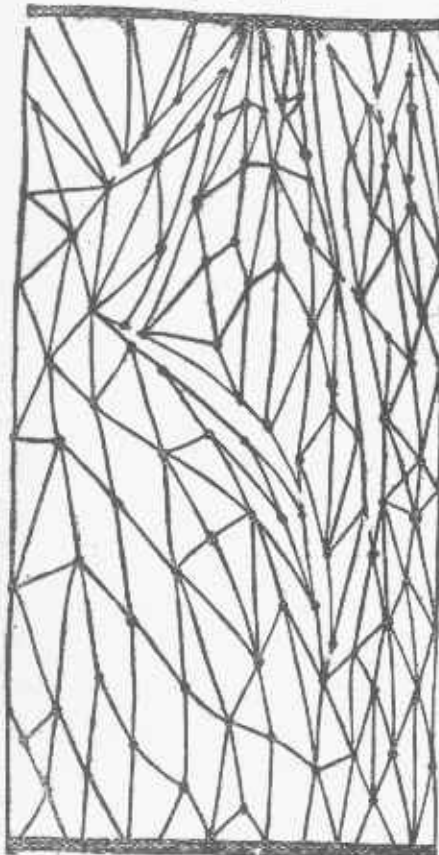

which shows the twelve breaks, beginning at the upper left hand corner.

Clancey's route is shown on the following diagram:

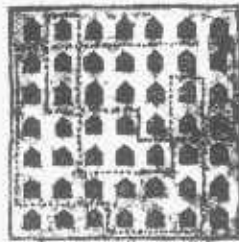

A Charade: Shaddock.
A Rebus: Pat.

Misc Bo-Peep must have had at least eight sheep in her flock. Eight posts arranged in a square would contain the same area as ten posts of an oblong—of course, assuming that the posts were in both cases set a uniform distance apart. For instance, if the posts he set one foot apart, an oblong with five posts on one side and two on the other would enclose four square feet and require ten posts. Whereas eight posts set one foot apart and arranged in a square will likewise enclose four square feet.

A Rebus: Myriad.

The clock dial was struck by the bullet at 10 o'clock, 21 minutes and 1-11 seconds as proven by the position of the second hand.

A half turn of Rip Van Winkle's picture shows that the features represent a little dog curled up:



The Admiral shows how he sank the five battleships in four rushes:

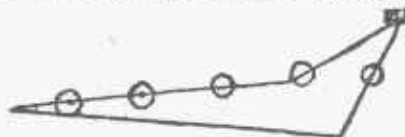

Observe that one of the circles is purposely out of alignment.

The illustrated proverb says: "In haste accuse no man."

Mandy's joke on Mr. Johnsing was "Pork-you-pine."

The pals at Sing Sing go by their numbers and not by their names, so if you gave "Forty" seven cents for the apples and sold them for seventy

you would make 900 per cent.

The Rebus Puzzle advises you to "be independent, but not too independent."

Jennie is evidently offering hay to that cow, outlined in the picture.

In the Frankfurter problem all that Harry had to do was to remember that if Jim paid 11 cents the others were supposed to have paid the same, which would make the 11 frankfurters worth 33 cents. Harry had bought 4 for 12 cents, so he should have 1 cent. Tommy had bought 7 for 21 cents, so he wants 10 cents of the money, and then each boy will have chipped in 11 cents. Concerning the equitable division of the sausages, it may be said that each boy was entitled to eat three and two-thirds of a sausage for his portion."

There were 17 Camels in the herd.

According to Biddy's verse her age is as much more than two as twice her age is than twenty. This makes her eighteen forty years ago and fifty-eight now.

SOLUTION OF BARGAIN COUNTER PUZZLE

Smith must have started out with \$99.98, and spent all but \$49.99. Now he has as many pennies as he before had dollars and half as many dollars as he previously had pennies.

Jennie's trick was to move that one ring from the left to the extreme right as shown.

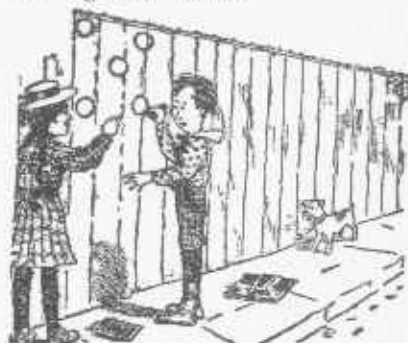

John Underwood's letter must have come from the Keystone state and was dated "fried A."

The Pictorial Algebra reads Pins + hoes + cart - shoes - car = pint.

The Kangaroo puzzle can be solved by any 12-letter word in more or less moves. The object, therefore, was to find a word which would best suit the play. The title of the puzzle; the reference to a bay in Australia, and other hints were given as aids to the word "Wooloomooloo," which solves the problem in twenty moves.

The following are the five geometrical forms:

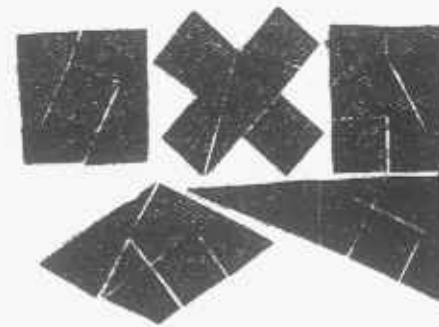

In Isaacstein's remarkable cut in prices, as the dealer has reduced the price 3-5 each mark down, the next should be 52 cents 2 mills.

SOLUTION TO REAL ESTATE

There were eighteen lots, bought at \$13.50 a lot, and sold at \$18, making a profit of \$81, which is the cost price of six lots.

The following routes show the answer to Puzzleland Park:

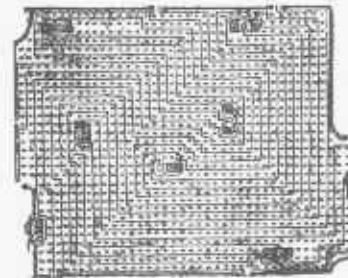

Sammy's Rebus in the story of the hunter and the squirrel say: "Nobody believes a liar."

In the election puzzle add the pluralities to the total vote and divide by the number of candidates. The quotient will be the vote of the successful one, from which the votes of the others can be ascertained by subtraction. The counts were 1,336, 1,314, 1,306 and 1,263.

Little Bo-Peep divided her sheep as follows:

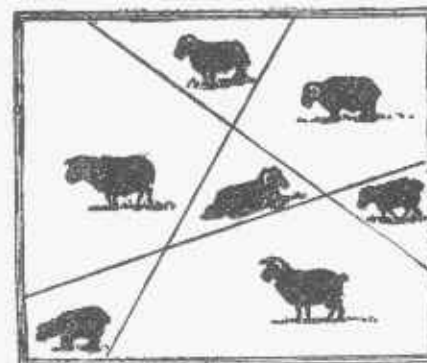

In that puzzle of the greatest catch of the season the real catch turns upon the statement that "the scales weigh nine pounds." Carefully note that it does not give the weight of the scales as nine pounds, but informs us that the scales will weigh anything up to nine pounds! Everything now becomes plain sailing as the weight of the fisherman is 125 pounds. So the weight of the fishes must be 2½ pounds, plus their scales ½ a pound, plus 9½ pounds as the weight of the scales. Total 12½ pounds, which equals one-tenth of the weight of the fisherman.

In that compound puzzle we know that he is not a young man as he is over forty. He is a scholar as he is intent on his letters: He is smart because he is bound to excell.

The Deaf and Dumb Story reads as follows:

The other day I noticed an excited woman who no one understood, creating a commotion on an elevated train. After vainly essaying French and German, it dawned on me that she was deaf and dumb. She quickly told with her fingers that her purse was stolen as she bought her ticket. Observing a ticket in her other hand, and thinking she had deposited her purse in the ticket box, I suggested getting off at the next stop to telephone back to the station master. He found the purse and sent it by next train.

The owner could not imagine how I recovered the purse, but I know from the look she gave me that she took me for a pick-pocket.

I hope the good lady may continue to live many, many days to tell of her thrilling adventure with a New York crook.

SAM LOYD.

The Darktown Patchquilt calls for two ways of getting eleven squares, so both answers are given:

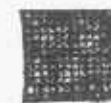
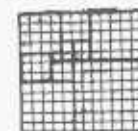

In the evolution puzzles we find the changes: Eat, cat, dot, dog. Boy, bay, may, man. Wood, wool,

cool, coal. Lion, limn, limb, lamb. Warm, ward, word, cord, cold. Fish, fist, fiat, feat, meat. More, lore, lose, loss, less. Fire, fore, ford, cord, cold. Ride, wide, wade, wale, walk.

The hidden city is Macon.

Mrs. Pythagoras shows the proper way of squaring her matting so as to preserve the pattern:

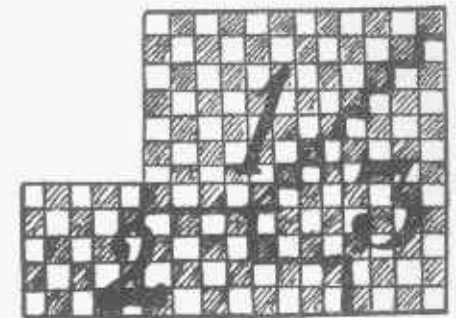

Here is what the telegram says:

Prof. Morse once took me to lunch at a new place on Dey street. I commented on the number of young people present, especially bright and pretty girls who appeared to be acquainted. He smiled knowingly at my remarks, but said nothing. We had been there but a short time when a young lady entered and took the next table. I noticed her bright auburn hair and snappy black eyes, an unusual but very pretty combination. A foreign-looking chap who was seated at the same table, stared rather impudently, and taking his knife beat the following tat-too upon the side of his plate: "Say fellows see me mash the per-oxid blond." The young lady calmly ordered her meal, thanked the dude for offering the salt and pepper, then taking her spoon she tapped off the following on the rim of her cup: "Girls I want you to see me teach a masher a lesson! When I give him the soup let every one contribute something." The impudent puppy rushed out followed by the shouts and jeers of every one. No one enjoyed the fun more than Prof. Morse who, in telling the story, always said the young lady was the wife of one prominent in electrical affairs.

SAM LOYD.

In that Trading Lot puzzle as the same proportion of squashes as acres is lost the farmers lose 4 squashes per acre.

Answer to the Fire-Escape Puzzle.

Despite its bland and child-like simplicity, as Bret Harte would say, there proved to be many curious little points about the Binks fire escape problem which escaped the attention of some of our keen-eyed puzzlists. It was told that the combined weight of the family and dog amounts to 390 pounds, and that it was only safe to lower thirty pounds at a time, although more could be lowered if the other end was properly counterbalanced.

Many answers were received, giving the greater weight to the husband, which the picture plainly refutes, or other plans which lower the dog or baby and then endow them with phenomenal and precocious intelligence which enable them to climb in and out of the buckets without assistance, all of which, as shown by the following correct answer, is not necessary.

We will first apportion the weight as follows:

Mrs. Watchman, 210 pounds; Mr. Watchman, 90 pounds; dog, 60 pounds; baby, 30 pounds, which we proceed to lower as follows:

- First—Lower baby, 30 pounds.
- Second—Lower dog, 60 pounds, and bring up baby, 30 pounds.
- Third—Lower Mr. Watchman, 90 pounds, and bring up dog, 60 pounds.
- Fourth—Lower baby, 30 pounds.
- Fifth—Lower dog, 60 pounds, and bring up baby, 30 pounds.
- Sixth—Lower baby, 30 pounds.
- Seventh—Lower Mrs. Watchman, 210 pounds, and bring up all the others.

- Eighth—Lower baby, 30 pounds.
- Ninth—Lower dog, 60 pounds, and bring up baby, 30 pounds.
- Tenth—Lower baby, 30 pounds.
- Eleventh—Lower Mr. Watchman, 90 pounds, bring up dog, 60 pounds.
- Twelfth—Lower dog, 60 pounds, and bring up baby, 30 pounds.
- Thirteenth—Lower baby, 30 pounds, and they have all reached the ground floor.

In giving the answer to the big watch puzzle, which was to tell the time of day always represented upon the signs in front of jewelry stores, I wish to correct a curious misapprehension which seems to have taken hold of the public mind. I was not surprised to find that almost every correspondent who vouchsafed an opinion on the subject stated that it was a well known fact that the time given upon the clocks was in-

tended to represent the hour when President Lincoln was assassinated. This rumor originated from the fact that many public clocks were stopped at 7:22 a. m., to represent the moment when Lincoln died, but the official records show that he was shot at exactly 10:30 the night before. There is no connection, therefore, between the death of Lincoln and the time upon the sign clocks, which, as a matter of fact, was adopted several hundred years ago, for the sake of symmetry, and to give a convenient space for displaying the jeweler's name upon the dial. The exact time, as indicated upon those sign clocks, with the hands at equal distances from the figure 6, can only be 18 and 6/13th minutes past 8, or as it may also be expressed: 8 o'clock, 18 minutes, 27 and 9/13th seconds. It constitutes a puzzling little problem which many good mathematicians failed to master.

The crescent can be divided into six pieces as shown, when by turning over one piece they will form the cross.

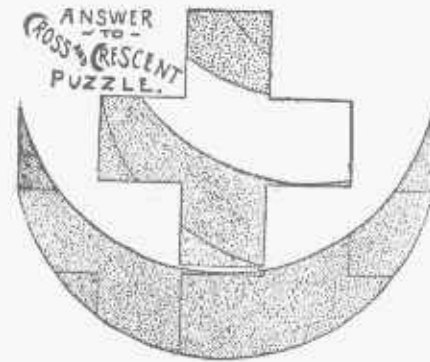

Puzzle of the Honest Milkman.

That honest milkman had five gallons of milk in can No. 2 and eleven gallons of pure water in can No. 1. Therefore, from can No. 1 pour five gallons of water into No. 2. Then pour six of that mixture back into No. 1, and then pour from No. 1 into No. 2 and there are eight gallons in each can, although in No. 2 there are three gallons of milk, and in No. 1 but two.

By selling from can No. 1 at 10 cents a quart he really gets 40 cents a quart for all the milk it contains, while for the other, which he sells at 5 cents a quart, he gets but 13 1/3 cents a quart, so he really gets three times as much for the milk from can No. 1 as for that from No. 2, which, therefore, is the correct answer to the puzzle.

Now, regarding that bit of Spanish legendry, the puzzle being to show how the eight rooms were occupied, so that there should be eleven persons on each side of the house, with twice as many on the top floor, it can be shown as follows:

Top Floor.	Second Floor.
1 5 1	1 2 1
5 5	2 2 2
1 5 1	1 2 1

After the nine were carried off, the rest were arranged as follows:

Top Floor.	Second Floor.
3 2 3	1 1 1
1 1	1 2
4 1 3	1 1 1

which shows eleven on all four sides in both instances.

The office boy's puzzle being interpreted says: "Trustee's room."

The Centennial Puzzle has sometimes been solved as shown in the first of these additions, but is plainly wrong as it gives two additions:

70	24 3/6	95 3/7
13	75 9/18	4 16/28
6		
5	100	100
4		
98	98 3/6	94 1/2
2	1 27/54	5 38/76
100	100	100
	1 6/7	57 3/6
	3	
	95 4/28	42 9/18
100		100

Six answers are shown using fractions.

In that Poetical Perplexity, the lines were written in the following order: Gray, Shakespear, Byron, Pope, Pope, Goldsmith, Pope, Goldsmith, Beattie, Milton, Young, Shakespear, Pope, Shakespear, Shakespear, Milton, Pope, Goldsmith, Gray, Shakespear.

Regarding that little puzzle in multiplication and addition, wherein it was required to show that other numbers besides 2 and 2 would produce the same results when added or multiplied together, I find that despite its extreme simplicity ninety-nine out of every hundred persons have always been led to agree with the editor of "Notes and Queries" in believing that 2x2=4 and 2+2=4 was an arithmetical feat in numbers which could not be duplicated with or without the use of fractions.

There are billions of simple answers obtained from the formula $x + \frac{x}{x-1}$, by giving any required value to x, as $3 + 1\frac{1}{2}=4$, or $3 \times 1\frac{1}{2}=4$.

In that matter of domestic complications, Mrs. Jones was the daughter of Smith and the niece of Brown, so there were but four persons. \$100 was contributed, \$92 spent and each received \$2 in the distribution.

Answer to the Fighting Fish Puzzle.

There would certainly have been a battle royal in the Siamese aquarium had there been as many fishes in that fight as I have received answers to the problem, and they all maintained such different views. There are answers galore worked out in trigonometry and algebra, showing how one side or the other should win out in from one to twelve minutes.

For clearness and simplicity as agreeing with the actual record of the last fight I am inclined to accept the following decision of the time-keeper as being correct:

Three of the little fish were paired off with each of three of the big fish and engaged their attention while the other four little fighters polished off the fourth big one in just three minutes. Then five little fellows tackled one big fish and killed him in two minutes and twenty seconds, while the other little ones were battling with the other big ones. It is evident that if the remaining two groups had been assisted by one more fighter they would have finished in the same time, so there is only sufficient resistance left in each of the big ones to call for the attention of a little fish for two minutes and twenty-four seconds. Therefore if seven now attack instead of one, they would do it in one-seventh of that time, or twenty and four-sevenths of a second. In dividing the little fish forces against the remaining two big ones—one would be attacked by seven and the other by six—the last fish therefore at the end of the twenty and four-sevenths seconds would still require the punishment which one little one could administer in that time. The whole thirteen little fellows concentrating their attack, would give the fish his quietus in one-thirteenth of that time, or one and fifty-three ninety-first seconds.

Adding up the totals of the time given in the several rounds—3 minutes, 2 minutes and 24 seconds, 20 4/7 seconds and 53/91 seconds, we have 5 minutes 46 2/13 seconds as the entire time consumed in the battle.

Regarding that ferryboat puzzle, I promised to show how the problem can be solved by common sense and simple addition, which I will proceed to do by reference to the following diagram:

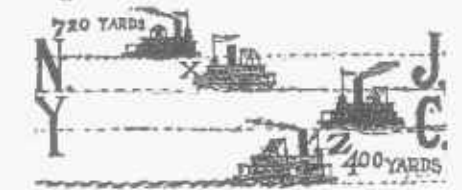

It was told that the two ferryboats started simultaneously from the sides of the river and met at the point X, just 720 yards from the New York shore. A glance at the sketch clearly shows that the combined distance which both have traveled is equal to the width of the river and that the black boat has gone 720 yards. Well, they continue their journey and reach the opposite shores, and the distance traveled is equal to twice the width of the river. The amount of time consumed at the landing is of no consequence and does not affect the problem. They started on their return trip and meet at Z, as shown. Now, the distance traveled by both is equal to three times the width of the river, as shown by the lines, so it is obvious that each boat has gone three times as far as when they first met, and had made but one width. The black boat had then gone 720 yards, so it has now gone three times that distance, viz., 2,160 yards, to Z. This the sketch shows to be 400 yards more than the width of the river, so all the mathematical work we are obliged to do is to deduct 400 from 2,160 to find that the river from New York to Jersey City is 1,760 yards wide, which is exactly one mile.

Without the aid of algebra, geometry or mathematics, we have solved by elementary kindergarten arithmetic a problem which would baffle half the mathematicians in the city.

In the Potato Race puzzle, it does not take much time to prove that 101,000 feet, or a little more than 19 miles, must be traveled to gather 100 potatoes placed ten feet apart. Despite of the fact that it

looks as if Tom, who was 2.04 per cent. quicker and should win in ninety-nine cases out of a hundred, yet Harry will win by the slightest possible margin if he takes the odds of the ninety-ninth potato. Tom being the quicker, will get the first potato, Harry the second, and so on to the last, but Tom never gets the chance to capture two adjacent potatoes.

Harry will have to go 49,980 feet to bring in his 49 potatoes, and as Tom can go 2.04 per cent. quicker, he could go just 50,999 and a half feet during the same time, but as he would have to go 51,000 feet to bring in his 50 potatoes, Harry will win by less than half a foot!

The lady who was "deeply injured" had removed a tight shoe!

In that moving day puzzle: First move the whisky flask 1, scrubbing brush 2, flatiron 3, whisky flask 4, pepper-box 5, mouse trap 6, whisky flask 7, flatiron 8, scrubbing brush 9, pepper-box 10, flatiron 11, whisky bottle 12, mouse trap 13, flatiron 14, pepper-box 15, scrubbing brush 16, whisky bottle—and the feat is accomplished.

In the Plumber's problem it will be found that a rectangular tank twice as wide as it is deep gives the most economical form. If a cube 12.6 feet square holds 2,000 cubic feet, then half that depth would give the required 1,000 feet.

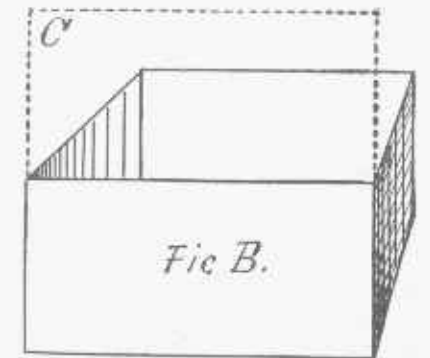

Our surveying class find that Crow Farm contained 58 acres.

To tell Mother's age experimentally, I would say that for every year of Tommy's age his father must have six, viz.: If Tommy is 1 his father would be 6 so by adding four years to each Tommy will be 5 and his father twice as much. So whatever age Tommy may be, as shown in the picture, he will be five times as old at the second stage, when their combined ages amount to 140. At first Tommy's age plus six times

his age, added to the mother's equals 70. So the mother's age and seven times Tommy's age equals 70. Then Tommy gets four times as old, and as the father and mother both take on the same number of years, we find that the adding of twelve times Tommy's first age has raised the combined ages of the three an extra seventy years. By dividing 70 by 12, therefore, we find that Tommy's age must have been 5 years and 10 months, the father six times as old, viz., 35 years, and the mother just 29 years and 2 months.

The second player should win in the Daisy game, but the secret is to keep the number of petals divided into two equal halves. If your opponent leads off with No. 1 you draw Nos. 7 and 8. But if he draws Nos. 1 and 2 you draw No. 8, and in both cases you would have the flower divided into two groups of five leaves on a side, as shown below:

Now continue the play by imitating his play. If he draws two leaves on the left side, you must draw the corresponding two from the right. If he draws a single leaf from the left, you draw a single from the right. By this system you keep the number of "pulls" even and must get the last play, which leaves him with the "stump."

Answer to the Great Pool Puzzle.

This complicated mix-up resulted from an expert agreeing to make as many balls as two inferior plays combined. A fourth player came in the game, however, and being a stranger of unknown strength, played upon even terms with each of the other three, neither giving nor receiving odds. The best player claimed that as he beat No. 4, he did not lose. But No. 4, having beaten No. 3, said that he could not be held for the game, while No. 3 maintained that in partnership with No. 2 he had beaten No. 1, and therefore, according to contract, could not be held for the game.

There are other complications which open up different lines of argument, but as No. 4 came in as a free-lance, he is not bound by any private agreements; so, when he made four to the low man's two, he put on his hat and coat and went home. No. 1 then had to live up to his agreement, so, as he had secured but five balls to his opponents' six, the defeat which No. 3 would have sustained was transferred over to

No. 1, who should pay for the game. But there is another view of the matter which would seem to reverse that verdict. No. 3 has scored against No. 1, by special agreement, but as No. 1 has beaten No. 4, he is relieved of all responsibility, and as Nos. 3 and 4 played upon even terms, without any agreement, No. 3 loses, as he can only plead the terms of the handicap when it is a question of paying between No. 1 and No. 3, unaffected by the acceptance of No. 4.

The Free Acres Problem.

Forty-three thousand, five hundred and sixty rails will just inclose that number of acres and is, therefore, the correct answer, which we get at in the following way: We first find the possibilities of one rail, so we cut a twelve-foot rail into four pieces three feet long, and by then cutting again for the four sides find that the one rail would enclose just one foot, so there are just 43,560 square feet in an acre, as one foot is to 43,560, gives the correct answer. Take 43,560 rails, divide by three to get the three-rail high, and by four to get the four sides. We then multiply the side by 12 again to get the length in feet, and find it is still 43,560, which we square to get the total number of feet. Divide again by 43,560, the number of feet to an acre, and we get the correct answer.

Answer to Missing Numbers.

A careful analysis of the sum, as presented in the Mormon souvenir, proves that the figures when restored must have been as follows:

749) 638897 (853
5992

3969
3745

2247
2247

0

Primitive Railroad.

1. Back the R engine far out to the right.
2. Run the R engine on to switch.
3. Run L engine with three cars out to the right.
4. R engine back to the main track.
5. R engine out to the left, with three cars to left of switch.
6. L engine on to switch.
7. R engine and cars to right.
8. R engine pulls seven cars to left.

9. L engine runs to main track.
10. L engine backs to train.
11. L engine pulls five cars to right of switch.
12. L engine backs rear car on to switch.
13. L engine draws four cars to right.
14. L Engine backs four cars to left.
15. L engine goes alone to right.
16. L engine backs to switch.
17. L engine pulls car from switch to track.
18. L engine backs to left.
19. L engine goes forward with six cars.
20. L engine backs rear car on to switch.
21. L engine goes to right with five cars.
22. L engine backs five cars to left.
23. L engine goes to right with one car.
24. L engine backs to switch.
25. L engine goes to right with two cars.
26. L engine backs to left of switch.
27. L engine draws seven cars to right of switch.
28. L engine backs end car on to switch.
29. L car goes to right.
30. R train backs to right.
31. R train picks up its four cars and skips.
32. L train backs to switch.
33. L train picks up its third car and goes on its way rejoicing.

Dollars and Sense.

U. S. A. money can be treated the same as English money, for if you take any row of figures and reverse them and deduct the smaller from the greater it will leave 99 or the multiple of 99, viz.:

\$8.57	9.31	4321
7.58	1.39	1234
-----	-----	-----
.99	7.92	3087

Answer to Counting Coins.

Heindricks had a 25-cent piece and a dime, Claus had a \$2.50 gold piece and a 2-cent piece, Karl had a dime and a 3-cent piece, and at the end of the play Heindricks had the 3 and 2-cent pieces, which would show a loss of 30 cents; Claus had the \$2.50 gold piece and one dime, which show a profit of 8 cents, while Karl has the 25-cent piece and one dime, which shows a profit of 22 cents.

In the remarkable story of the three Dutchmen and their wives who came to town to buy hogs, it was told that each person bought as many hogs as they paid shillings per hog, and that each man spent three guineas more than his wife; likewise that Hendrick bought 23 more hogs than Caterin, and Claas bought 11 more than Ceertring. The puzzle was to pair the husbands and wives as proven by their purchases. It results in a curious complication of extracting the square roots of the pigs and wives which finally results in showing that Ceertring bought 1 little pig for 1 shilling, and that her husband who must have been Cornelius bought 8 hogs for 8 shillings each. Caterin bought 9 for 9 shillings each, while her husband Claas bought 12 hogs for 12 shillings each. Anna bought 31 large hogs for 31 shillings each, while her good man Hendrick by name, bought 32 hogs at 32 shillings apiece.

The Diamond Robbery.

The second arrangement of the diamonds, with two gems missing, is as follows:

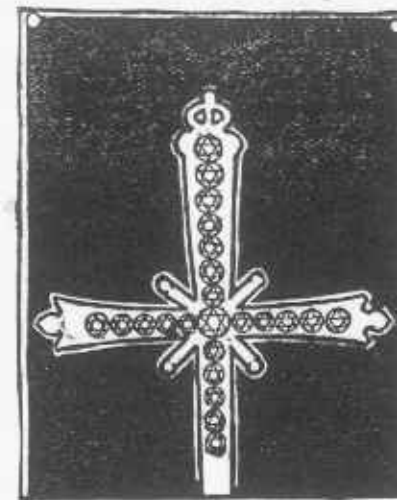

Answer to Puzzling Letter.

Our young folks have come nobly to my aid in deciphering that cryptographic letter from my boy on the farm, and tell me that instead of being a Ku Klux notice from the Molly McGuires, it is merely a statement that "the season is backward for potatoes!" The cc on is (backward) 4 put oooooooo (eight o's). All of which is a great relief to an anxious parent.

The Water Lily Problem.

Euclid says: "That when two chords of an arc intersect within a circle, the products of the parts of

one will be equal to the products of the parts of the other." Therefore in the following illustration the surface of the water forms the chord of one arc, and as the two parts were given as 21 inches, 21x21=441.

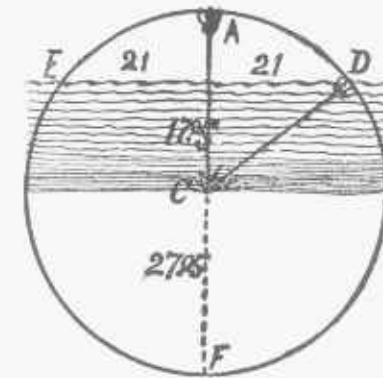

The stem of the lily forms the other intersecting chord, and as its height above the water forms one part of the chord, that part, 10 inches, multiplied by the other part, must be the same as the 441 inches obtained by the parts of the other chord. So divide 441 by 10, and we get 44.1 inches as the other part of that chord. Adding the 10 and the 44.1, we get 54.1 for the total length of the chord from A to F, which is the diameter of the circle. This we must halve to get the radius, 27.05, but as the flower stood ten inches above the surface of the water, we will find that the lake was only 17.05 inches in depth.

The Missing Number.

As the digits add up 45, which in turn make 9, the sum must also equal 9, therefore we know that 8 is the required figure.

Missing-word Anagram.

Vile, evil, veil, Levi and live.

Answer to the Hot-Cross-Bun Puzzle.

The wording of the song of the hot-cross-bun man shows that there must be an even number of children, as there were just as many daughters as there were sons. Seven pennies were to be invested in buns at the rate of a penny, two for a penny or three for a penny. The supposition is that there were three boys and three girls, so by purchasing six buns two for a penny and twelve three for a penny each child could then receive buns according to programme, one half-penny and two three-for-a-penny buns to each. Despite the various attempts to solve

the puzzle in other ways, this will be found to be the only answer.

Ancient Order of Iron Cross.

The following illustrations show how to cut the cross into only four pieces:

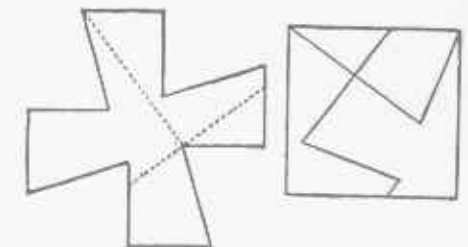

The Battle Royal.

The accompanying illustration shows how the chess board which the young Dauphin broke over the Duke of Burgundy's head was restored by the court carpenter.

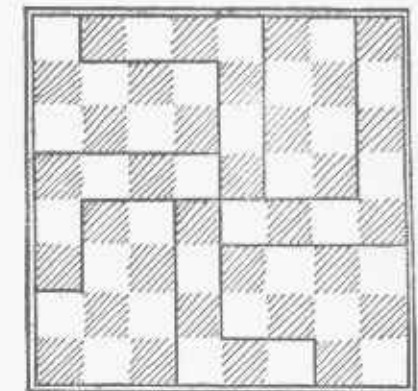

Guido Mosaic Puzzle.

This puzzle is based upon that famous 47 problem of Euclid which proves that the squares of the side and base must equal the square of the hypotenuse. We here see that 3 square and 4 square equal 5 square:



Problems of History.

To that curious study of the nine ponderous volumes of Hume's History of England which were to be arranged upon the two shelves so that the two rows of figures might be made to represent fractions equivalent to one-half, or one-third, one-fourth, one-fifth, one-sixth, one-seventh, one-eighth or one-ninth, the following clever arrangements have been received as fulfilling the conditions:

6729	1	5832	1	4392	1
13458	2,	17496	3,	17568	4,
2769	1,	2943	1	2394	1
13845	5,	17658	6,	16758	7,
3187	1	6381	1		
25496	8	57429	9.		

Of course, some of the numbers can be slightly varied and yet give the same results.

In that bottle puzzle, only two burglars were in view, but it does not take a Sherlock Holmes an instant to prove that there were three burglars in this gang; there were 21 pints of wine to be divided and 24 bottles, and as three is the only number which will divide those quantities, we know that there must have been three men, so we will go on with the puzzle part of the question, which even at this stage of the game calls for a sober brain.

One burglar takes 3 full quarts, 1 empty quart, 1 full pint and three empty pints. Each of the others take 2 full quarts and 2 empty ones, 3 full pints and 1 empty one, so each man gets three and a half quarts of wine, and four large and four small bottles.

Poetical Decapitations.

Growing, rowing, owing, wing.
Trifling, rifling, I fling, fling.
Caprice, a piece, rice, ice.

Pythagora's Classical two-square problem solves itself by the application of the rule which shows that the combined squares of the smaller sides of a right-angled triangle are equal to the square of the largest. Taking our scissors we cut from A to B, which produces a triangle whose base and elevation are equal to the sides of the two squares as given in the puzzle. The line of the hypotenuse, therefore, should show the dimensions of the large square which combines the other two

squares. We therefore cut from A to C and clip off another triangle and fit the three pieces together so as to form the large square A B E C.

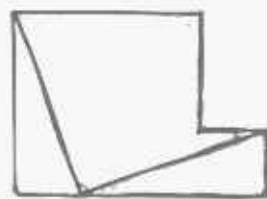

This rule holds good to give the combined size of any two squares:

Answer to Fo'castle Yarns.

In reply to those conundrums of the old salt who asked Neptune what he would do if all the seas were dried up, that jolly old sea god replied: "Really, I would'n't 'ave an ocean." In reply to the clever conundrum: "Why is a man looking for the philosopher's stone like Neptune?" the jolly tar's quaint reply was "Because he's a sea king what never was."

Man With the Hoe.

There being just twelve rows, as shown in the picture, Hobbs would drop six rows in 120 minutes, and we will then say, could cover at the rate of a row in sixty minutes, so he would drop and cover his six rows in eight hours. Nobbs, according to statement, would drop his six rows in 240 minutes, and could cover them at the same rate of speed, so he would also finish his work in eight hours, so each man would be entitled to \$2.50 for eight hours' work.

The "Mysterious properties of 9" may be applied to test the correctness of subtraction by finding the "root" of the minuend and subtrahend as well as remainder and the difference must be equal to the root of the remainder. For example:

$$\begin{array}{r} \text{From } 6894321 = 6 \\ \text{Take } 2960864 = 8 \\ \hline \text{Leaves } 3933457 = 7 \end{array}$$

As 8 cannot be taken from 6 we will add 9 before deducting the root 8; this leaves a difference of 7.

Answer to the Boxer Puzzle.

This odd little puzzle-game proved to be replete with opportunities for surprises and fine points of play, as shown in the following answer, which proves that the first player should score seven boxes by beginning with a line from G to H. If the second player then marks from J to K, the first will score two boxes by marking from K to O and P to L, and will then play the waiting move, L to H, instead of scoring two more boxes. The other player now scores the two boxes by G and K, and is then compelled to make a play which gives the first player five others. If, when the first player marks from G to H, the second player marks C-G, B-F, E-F, and then makes the waiting play of M-N, which scores four more boxes. It is this sharp play of giving your opponent two boxes so as to then get four which constitutes the pretty points of the game.

Answer to Picket Posts.

To that odd little lesson in military tactics wherein it was required to place sixteen checkers upon a board of sixty-four squares so that no three should be in line from any possible direction, the accompanying diagram shows the correct answer. The stipulation of beginning by first placing two men in the center of the board bars out many answers which would otherwise be quite as correct as the one here shown:

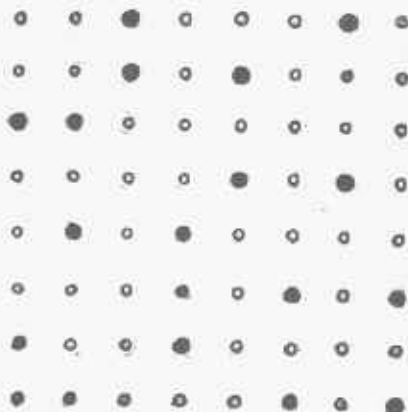

That puzzling return trip from the Klondike proved to be no easy task for our young puzzlists, and but few succeed in getting out of the woods with their treasure. For the benefit of such as could not escape the endless whirlpool of numbers which held them in its vortex we will say that the only escape leads through the backward and forward sequence of S. W. to 4, S. W. 6, M. E. 6, M. E. 2, M. E. 5, S. W. 4, S. W. 4, S. W. 4, and a bold strike via N. W. to liberty!

Those who failed to master it readily discovered that one false step at any stage of the game throws one into the whirlpool from which there is no egress.

Answer to Jack and the Box.

The following illustrations show how to cut the box into two pieces which will fit together and form a perfect square. Cut on the dotted lines, as shown in Figure 1, and the pieces will fit together to form a square, as shown in Figure 2.

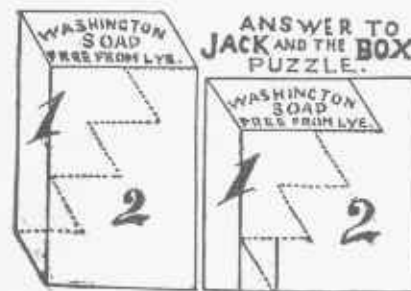

Answer to the Fore and Aft Puzzle

This curious and interesting puzzle is given in the puzzle books to be solved in fifty-two moves, but many of our clever puzzlists succeeded in demonstrating the possibility of performing the feat in forty-seven plays. Some attempted to give a shorter method, but erred in counting the moves incorrectly.

As there is never more than one vacant square to be covered, it is only necessary to mention the direction of the play, as shown in the following sequence of forty-seven changes: East, West, West, East, South, North, North, South, East, South, West, North, West, North, West, South, East, East, South, North, West, North, South, South, East, North, West, North, East, West, South, West, North, East, South, East, West, West, East, South, North, South, and the feat is accomplished.

The Dewey Pillow puzzle reads: Good people always die young.

Answer to Crows-in-the-Corn Puzzle.

The accompanying diagram shows the correct way of picketing the cornfield with eight crows so that every bird has an unobstructed view of all the others, and so that there are no two birds in the same row or diagonal. It being also impossible for the hunter to discover any standpoint from which he might get a line-shot on three birds.

The second diagram shows one of the many answers submitted by our chess experts who attempted to prove that the puzzle is similar to the famous problem of placing eight queens on a chess-board so that no one attacks another. Chess players, however, know more about rooks than crows, as the hunter readily discovers that two of the shots illustrated would wing three birds, while in the first diagram no such feat is possible if the exact center of the points are calculated upon.

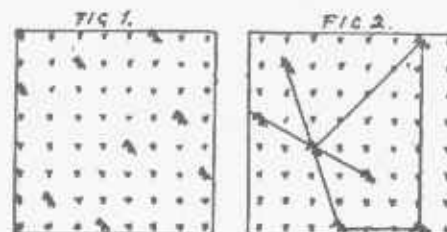

The Secret-of-Success Puzzle.

"Don't do business on tick," said the clock. "You lack push," said the button. "Don't be led," said the pencil. "Take pains," said the window. "Whoop your business and never lose your head," said the barrel. "Don't do a light business," said the lamp. "Look alive and be sharp not mild," said the cheese. "Keep your eyes peeled," said the potatoes. "Have plenty of sand," said the sugar. "Don't get blue," said the indigo. "Never cut price nor lose your temper; be sharp," said the knife. "When you see a good thing stick to it," said the fly-paper. "Keep cool," said the refrigerator. "Never get stuck on yourself," added the tack. "Keep your hands busy and never sell on time," suggested the clock. "Yes, C. O. D. is the best," said the salt fish. "Beware of the beats," remarked the

vegetables. "Yes, look out for the skins," said the banana, "for as the mucilage says, 'It's bad business to get stuck.'" "Prices should not be too steep," remarked the Oolong, "for honest tea is the best policy." "Yes, make your prices draw," said the stove; "give every one a warm reception, and always honor your draughts." "Bills should be met," said the chicken. "And should be promptly reseeded," added an old chair. "Meat your customers with a smile," said the corn-beef. "Try to soot everybody," suggested the stovepipe. "It is your winning weighs that have the most weight," said the scales. "But don't get caught," added a saucy little sardine. "No, you mustn't lye," said the pot-ash. "Yes, do write," interposed the pen. "Polished manners are very effective," said the blacking. "It shows you are well bred," remarked the flour. "Give your patrons no grounds for complaint," remarked the coffee. "Keep in the swim," suggested the smoked herring. "Give greater bargains every day," said the nutmeg. "That's a great idea," remarked the stove, "but don't have too many irons in the fire." "Nor count your chickens before they are hatched, for it's too bad to be beaten," said a fresh egg. "Rise early and work," suggested the yeast. "Yes, the sooner you are out of bed the better," remarked the asparagus. "Loafing makes you stale," said the bread. "It gives you a seedy look," suggested the orange. "Raising the dough is more important, as you may need it," said the baking-powder. "Look after the scents, the dollars take care of themselves," remarked the limburger. "That's right, look after the little leaks," said the onions. "Be up to date," suggested the calendar. "It is best to reflect seriously," said the looking-glass, "for as the cement says, 'It is never too late to mend.'" "Well, well," said the ink, "if you want to suck seed you only waste thyme on a navel orange." At this all the articles laughed, and the grocer awoke, an astonished Budweiser man.

The labor strike puzzle conceals the name Newark. In the "noted" puzzle we discover "Eldorado."

In the problem of the hounds and the hare, the hounds gain 6 rods in every 21. They must therefore run as many times 21 as 6 will go into 96. Therefore $96 \div 6 = 16$. $21 = 336$ rods.

Patience and perseverance, combined with cleverness and a certain amount of luck, will enable a good domino player to demonstrate that—contrary to popular belief—200 points might possibly be scored in a game of straight muggins. The problem ran the gauntlet of the mathematicians and experts some years ago, when, by careful analysis, the limit was raised to 195. But I afterwards discovered that by one pretty stroke of play, which seemed to have been overlooked in the discussion, five more points could be scored, which struck me as being worthy of being presented in puzzle form. The play may be slightly varied, but is substantially as follows: First lead the three-two, and continue to build up so as to present the following lines: 5-5, 5-6, 6-6, 6-2, 2-1, 1-1, 1-4, 4-2, 2-2, 2-3, 3-3, 3-1, 1-6, 6-4, 4-4, 4-3, 3-6, 6-0, 0-3, 3-5, 5-0, 0-0, 0-4, 4-5, 5-2, 2-0, 0-1, 1-5



Answer to Disputed Claims.

The finding of two triangles of equal area, such as base 40, elevation 48, and the hypotenuse 148, which would contain the same area as one with an elevation of 80, a base of 84 and the hypotenuse of 116, is not difficult. To find the third right angled triangle which will also contain 3,360 square feet is so difficult that such noted mathematicians as Euler and LaPlace are said to have claimed that it was impossible to discover a fourth.

Here is the third: Elevation of 30, base 224 and hypotenuse 226.

CHARADE—Steel-yard.

Sam Loyd's Puzzle.

The chances are 125 to 108 that you will lose, for if you select one number and then play all the chances 125 would lose and 81 would win. But as there are 15 throws which would win an extra \$1 and one triple throw which would win an extra \$2, the correct answer is that you would lose \$125 to win \$108. The part of winning \$108, which is half of the possible 216 chances, has led writers on the subject into the error of saying that the chances are even. The error appears when you play all six numbers, then you get

your money back if three different numbers appear, but if three of a kind turn up you get back only \$4 for an outlay of \$6.

Regarding the answer to the Crazy Hatter's conundrum as to "why is a writing desk like a raven?" there is no absolute certainty of any answer having been intended, as Lewis Carroll never vouchsafed any replies to the curious problems pertaining to Alice's trip through Wonderland; nevertheless, my acquaintance with Carroll and his peculiar traits, convinced me that it was not altogether a haphazard query. My own guess, following the alliterative style which characterizes the entire work, would be "that the notes for which they are noted are not noted for being musical notes"; nevertheless, there is considerable scope for ingenuity and cleverness, as other answers, equally as good or better, might be suggested, like "because Poe wrote on both," "Bills and tales are among their characteristics," "Because they stand on their legs," "Because they conceal their steels" or "Ought to be made to shut up," etc., etc.

Concealed Geography.

71, Hebrides; 72, Arno; 73, Sorrento; 74, Reading; 75, Borneo; 76, Basel; 77, Po; 78, Orleans.

Aesop's Eagle.

There were three traps to avoid in this puzzle: The circumference of the earth at the latitude given would be but 19,055 miles. Gaining 500 miles per day would require 39 days, but having gone around the world gained one day. Then the old principle of the frog in the well puzzle comes into play, as he does not have to fly back when he once gets there. Ans., Friday, Feb. 7th.

The New Year's Resolution reads "Be always upright, honest and industrious."

How to make Diamonds is shown in the following illustrations:



News Boy's Puzzle.

The Joneses won out by 220 papers.

A Riddle.

Auctioneer: Concealed geography conceals "Easton."

The old time proverb rebus reads: "Early to bed and early to rise, makes a man healthy, wealthy and wise."

All About a Penny.

We see in the illustration: Hare, Date, Temple, Tulips, Neck, Star, Brow, Eye, Lids, Lash, Crown, Month, Liberty, Copperhead, Locks, One Cent by the U. S. A.

Susie paid 5 cents for silk, 4 cents for worsted.

In reply to the question as to which of the States can be spelled with two letters, it may be said that oO represents o high o, while we all know that I O A and X a c (Ten a c) require but three letters each.

Arithmetical Puzzle.

99 9/9 = 100.

No. 1907 was Mashed Potatoes.

Couldn't Tell a Lie.

There were originally 8 in the box.

The Inspector's Puzzle.

Articles weighed on false scales will register out of their true weight in the same proportions as the lengths of the arms from the fulcrum point are to each other. The rule is:

"Weigh the articles on one side of the scales, then upon the other. Multiply the two results together and the square root of the product will be the true weight of the article."

On the long arm one pyramid equaled two and two-thirds cubes, while on the short arm it weighed one-sixth of a cube.

One-sixth multiplied by two and two-thirds equals four-ninths, the square root of which is two-thirds.

Therefore, a pyramid weighs two-thirds of a square.

Assuming that a pyramid weighs one ounce, a cube would weigh one and one-half ounces, and the answer to the question, "What should have been the true weight of the eight cubes?" is twelve ounces.

Answer to Candy Puzzle.

The children must have bought three packages of fudge at four cents each; fifteen chocolate drops for seven and a half cents and two gum drops to make up the extra half cent.

Answers to Puzzles.

In False Alarms the locality was "Athens."

The Little Brown Jug.

To coin an expressive term which explains the situation, I would say that the problem is best solved by the principle of symmetrical equivalents, which resolves a geometrical form into a certain number of parts which can be duplicated. By counting the number of branches, it will be found that there are, as a matter of fact, but five starting points to be analyzed, which will give a total of 372 ways of spelling red rum, which reaches the center.

Then comes the curious feature of the puzzle, although the same is very self-evident, for there must be just as many ways of getting out as there were of reaching the center, so the square of the sum 372x372 gives the grand total of 138,384 ways without any two being alike. The trick of the puzzle turns upon the fact of there being a dozen R's in the middle of the diagram, which may be used as starting and finishing points.

Answer to Squaring Accounts.

In that story of the temperance town we find that the agent started with \$12 cash and \$59.50 in liquors, and in buying \$283.50 more increased his stock to \$343 wholesale. Upon this he put an advance of 10 per cent. for a retail profit, which raises the value to \$377.30. He sold \$285.80 at retail, which leaves \$91.50 on hand, as shown in the picture, which balance would be worth at wholesale, \$83.18. The profit on the sales would amount to \$25.98, which, added to the \$12 cash and \$59.50 liquors with which he started, would amount to \$97.38, from which we deduct his commission of \$14.29 to leave \$83.19 for the balance on hand, which shows the accounts to be correct within two cents.

Hope cheered the pilgrim in that rebus puzzle.

The Pony-Cart Puzzle.

The circumference of the track described by the outer wheels of the cart in making the turn may be solved mentally as follows:

For the outer wheel to go twice as fast as the inner, the circumference of the outer circle must be twice that of the inner. As five feet is equal to half the radius of the outer circle, ten feet must be the radius and twenty feet the diameter

of the outer circle. 3.1416 times twenty feet gives us 62,832 feet as the circumference of the circle described by the outer wheel.

That missing word is "brigand," so the sentence reads: The brigand placed the loot in his brig and escaped.

Answer to Smith's Age Problem.

It was mentioned that this statistical problem was sprung upon her husband on the 29th of February, so, as our sharp puzzlers readily discovered, it must have been February 29, 1896. When they first met at an earlier stage of the game, he was three times her age, but on that eventful leap-year day she was the age he was when first they met. Mathematicians and others deep in astrology and the occult sciences demonstrated that Tom was fifteen and his sweetheart five when first they met, so on the 29th of February mentioned she would be fifteen and he would be twenty-five. So, when she is forty-five he will be fifty-five, which would make their combined ages amount to the required century run.

Some of our scientists, however, who reasoned that Tom was twenty-five on the 29th of February, 1896, fell into the error, as did Tom himself, in thinking that 1900, which came four years after, was a leap year, which would make Tom just 29 years old. By some odd freak of the calendar, as explained by the dream books, 1900 was not a leap year, so the next leap year did not occur until 1904, on which eventful occasion Tom was 33 years of age and was free once more to continue his course of statistical training, and that good old rule of dividing the year by 4 to determine whether it is a leap year or not was again in force.

The traveler by express went via "Bolivia."

Peaches and Pears.

Many of our puzzlists succeeded in placing ten peach trees so as to form five rows of four-in-line. Some found it an easy matter to locate the peach trees properly, and a few succeeded in getting the per-simmons in line, but the plum question was too difficult for the average puzzlist to master.

Utilizing spades, clubs, hearts and diamonds to represent the four varieties of fruit and the dots to the remaining quinces, the accompanying

diagram gives the answer to this remarkably difficult puzzle.

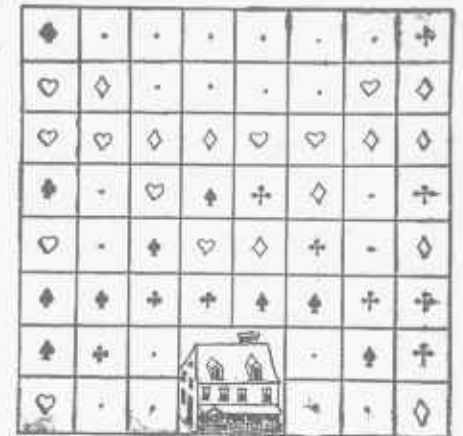

Puzzle of the Harlem Goats.

In Professor Blumgarten's unique satire upon the workings of the Peace Congress, he gave by way of illustration one of George Abercrombie's curious deductions regarding the strength, or resisting power of a goat's skull. The distinguished scientist, who lived before the advent of the Society for the Prevention of Cruelty to Animals, says: "By repeated experiments I have found that the strength of a blow equal to the momentum of 30 pounds falling 20 feet, will just break the skull of a goat, so as to kill it."

The problem was to determine the relative speed of the two animals necessary to kill both. Of course, the problem turns upon the well-known law that a heavy body falling from a state of rest, descends in the first second of time 16 feet and 1 inch, after which it increases in speed in a regular geometrical progression, from which we compute that the 30 pounds falling 20 feet, would give a blow equal to the contact of a 57-pound goat running at the speed of 9.4395 feet per second, meeting a 54-pound goat coming at the rate of 9.9639 feet per second, which would therefore just kill both of the belligerent animals. Of course, it is assumed that the goats strike with equal momentum and 'drop dead in their tracks,' otherwise the velocity of either goat might vary from 0 to double the velocity given.

In the "naughty" puzzle six straight lines will make the naughts read, "Good dog do go."

That saving life puzzle conceals the name of Astoria.

That philanthropist thought the old horse loved to respond to the

call of whoa, but Sydney Smith's puzzle turned upon the word "class." Tootsey Wootsey resided at Babylon.

His two stock jokes were in telling that the boat was the Maid of the Mist, and the "cat erect" was like the falls of Niagara.

That big pain occurred in Boston. Harry's donation motto says, "a fool and his money soon part."

Answer to Bunny Puzzle.

Here is the way we discovered the mischievous little white bunny which overturned one of the jardineres of rare exotics. You can see the cause of the catastrophe in the center between the two vases nibbling at the leaf.



The Old Beacon Tower.

There were two tricks or pitfalls into which mathematicians and puzzlists fell. It is a simple matter to prove that the length of the hand rail would represent Pythagoras' line of the hypotenuse of a right-angled triangle. Take a triangular piece of paper and wrap it around a pencil and B to C is the length and A C the hypotenuse.

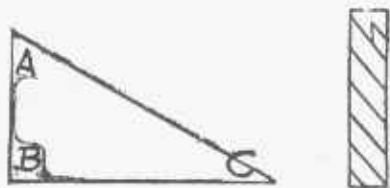

Now, in the Beacon Tower problem the height is 300 feet, and, as the diameter of the circle is 23 feet 10 1/2 inches, which multiplied by 3.1416 would give a circumference of 75 feet, which four times around would also give 300 feet as the length of the base, and the rail would be equal to the length of the line of the hypotenuse, which, however, is the first of the catches, for some of the puzzlists and mathematicians forgot that it takes just as

many pickets for the base as it does for the hypotenuse, according to the old puzzle of the pickets of a fence which goes over a hill:

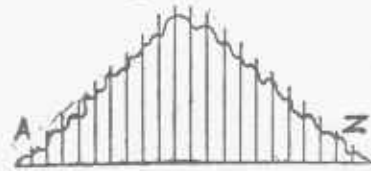

Whether you go from A to Z direct on the level or over the hill there are just 35 pickets, just one foot apart. So in the problem of the Beacon Tower, as four times the circumference would be 300 feet, there would be 300 pickets plus 1 for the top, which is the second point of the problem which so many overlooked, and which makes the correct answer to the puzzle to be 301 pickets or steps.

Charade-Mama.

That Indian is "a well read man" and the inscription tells you to "th in k twice before u speak."

The toboggan puzzle conceals the name Canada.

The Corner-in-Wheat.

In that odd bit of encyclopedia lore, regarding the agreement made by Sheran, the Indian King, to reward Sessa for inventing the game of chess by giving him one grain of wheat for the first square, two for the second, four for the third, etc., always doubling up to the 64th square, it was asked to tell how many grains of wheat would be required to pay the debt.

It is a question of simple multiplication for anyone who can do sixty-three sums without an error, and when we see the answer it looks easy and yet no human mind realizes or grasps its immensity. It was easy for Sessa to compute his store of wheat, but to count the grains was a different matter.

A trillion is a small number if you say it quick, yet we cannot grasp it. According to the old legend the "Wandering Jew" was to walk the earth until he counted a trillion. If he could count one a second for ten hours a day it would be a 75,000 year contract. So do not waste any brain energy in endeavoring to take in the immensity of 18,446,744,073,709,551,615 grains of wheat!

- 1— 1 "In this problem of
- 2— 2 doubling each succes-
- 4— 3 sive square until 64
- 8— 4 squares are reached

- 16— 5 would give us a table
- 32— 6 running like this, which
- 64— 7 is known as an arith-
- 128— 8 metical progression.
- 256— 9 To continue this up to
- 512—10 64 and then adding for
- 1024—11 the sum total becomes
- 2048—12 somewhat laborious, es-
- 4096—13 pecially when the upper
- 8192—14 numbers are reached.
- 16384—15 It then becomes a ques-
- 32768—16 tion, 'Can this be
- 65536—17 reached by a shorter
- etc., etc. method?'

A glance at the table shows certain characteristics, that the amounts bear certain relations to each other. For instance, the 3d and 5th terms multiplied together give us the amount for the 7th term; the 6th and 12th for the 17th, the 7th by the 7th for the 13th and so on infinitum, which seems to give us a rule that by adding the numbers and subtracting one we get the number of the term they produce.

According to the above the 8th term (for instance) multiplied by itself would give us the 15th term (8+8-1=15), that is 128x128=16,384, for the 15th term.

Now, according to the rule, the 15th term, multiplied by itself, would give us (15+15-1=29), the 29th term, that is 16,384x16,384 equals 268,435,456 for the 29th term.

Then the 29th term multiplied by itself would give us (29+29-1=27), the 57th term, or, in other words, 268,435,456, multiplied by itself gives 72,057,594,037,927,936, for the 57th term.

Still applying the rule, multiply the 57th term by the 8th (57+8-1=64), for the last or 64th term, that is 72,057,594,037,927,936x128 gives 9,223,372,036,854,775,808 for the last term.

Now all of the 64 terms must be added together. This would be a pretty big addition, enough to frighten the average school boy. This is overcome by a very simple rule: The sum of an arithmetical progression is found by doubling the last term and subtracting the first term from it, thus we can easily find the sum total to be 18,446,744,073,709,551,615 kernels demanded by this checker-board proposition."

Kate's charade turned upon the word potatoes.

The milkman's retort tells us that the chair, like his bill, should be re-seated. His cow gives milk but

the chair "gives way." The chair, like the dress, should be sat in.

The bad boy dreamed of Lewiston.

Santa Claus started off with his left foot to chase that turkey and if you follow in his tracks in the snow counting left foot, right foot, etc., you will find he has gained one step somewhere. This can only be done by going round the first circle twice, so he has made four complete turns to arrive at his present position!

Answer to Bird Puzzle.

The question as to whether a bird flying round in a closed box would increase or lessen the weight of the box has been discussed pro and con, by some of our correspondents, but the preponderance of opinion is so overwhelmingly in favor of the weight of the bird being added to that of the box, that it would be difficult to present reasonable argument for the other side, despite of the popular belief that such would be the case. The propounder of the question cited the familiar problem of the fish in a vase of water, but there are two versions to that problem; the one which asks why a fish put into a tank of water does not increase its weight is a silly joke, as it does increase the weight, unless the tank being full to the brim and enough water overflows to equalize matters. The problem of the fish is not the same, as the weight of the fish is the same as the water and the fish floats. The bird is heavier than the air and supports itself by striking down upon the air and the power of such strokes would undoubtedly show on the dial the difference in weight between the bird and its displacement of air.

The man with the monkey was in Cuba.

Cross-Country Running.

First to give the answers: It may be said that the hound runs back 111 yards 1 foot and 1 and 1/11 of an inch to the left-hand bridge, and thence across the field on the hypotenuse line 713 and 7/11 yards.

This shows the hare to be 850 yards from the home flag going by either route. Mathematicians show that the total length along the canal would be 111 and 4/11 yards. Plus the 25 yards to the hare, plus the 250 yards to the right-hand bridge, would make the distance from bridge to bridge 386 and 4/11 yards

as one side of a triangle, with 600 yards as the other, which gives 713 and 7/11 yards as the lien of the hypotenuse, according to Euclid's forty-seventh proposition. This proves the answer to be correct, which I will now proceed to obtain by the natural puzzle method.

To discover that unknown distance from the hare to the left-hand bridge, when the two routes are of the same length, merely divide the base of the triangle (that 600) by the distance of the hare to the bridge, 250, and to the quotient add 2, and with that sum once more divide the base, and the quotient will be the distance from the hare to the left-hand bridge, viz., 250/600(2.4, to which we add 2-4.4, which, divided into the 600, gives 136 and 4/11 yards as the distance from the hare to the left-hand bridge, and as the two routes are of equal length it would make the cross-lots cut 713 and 7/11 yards, as previously mentioned, and we have not stumbled over any square roots on our run.

Answer to Golf Puzzle.

In the description of golf problem, it was explained for the benefit of the few, if such there be, who know less than ourself about this exciting pastime, that there were nine holes located respectively 150, 300, 250, 325, 275, 350, 225, 400 and 425 yards apart, which were to be reached in succession by two strokes of different lengths played directly towards the holes. Some of our clever players prove that the feat can be performed in 26 shots by using a 150 yard drive and a 125 yard approach.

In that confusing bit of Celestial financing, which called for the price of a fat puppy dog for 11 bits, when 11 round coins are worth 15 bits, 11 square ones 16 bits, and 11 triangles 17, such of our puzzlists and mathematicians as are up in Oriental laundry lore report that the transaction would be consummated by paying 7 pieces of cash with round holes and one piece with a square hole. The total value of the eight pieces would be exactly 11 bits. The amount in our money would be such an insignificant sum that it could hardly be estimated, and as I don't believe anyone would care a bit about it, we won't try.

The Mixed Tea Puzzle.

There is a cute puzzle method for solving such puzzles of this kind,

which shows that two square boxes, the one exactly 17.299 inches inside measurement, and the other 25.409 inches square on the inside, will be equal to twenty-two tea chests, exactly 9.954 inches square. So the proportions of green and black teas must have been mixed in the proportions of as 17.299 is to 25.469.

That Grammatical puzzle may be entirely changed by substituting the letter S for the L at the very beginning, so it reads: "Set the rich, etc."

The Time Puzzle.

Regarding Harry's problem of the clock, which conflicts with the popular notion of this old-time puzzle, it may be seen that if the minute hand goes twelve times faster than the hour hand that they will meet eleven times during every twelve hours, so by taking the eleventh part of the twelve hours for our constant we find that there will be a meeting of the hands every 65 minutes 27 and 3/11 seconds; therefore the hands will be together at 12 o'clock and at 1:5:27 3/11, 2:10:54 6/11, 3:16:21 9/11, 4:21:49 1/11, 5:27:16 4/11, 6:32:43 7/11, 7:38:10 10/11, 8:43:38 2/11, 9:49:5 5/11 and 10:54:32 8/11.

The Square-Deal Puzzle.

Out of an unusually large number of competitors to this curious bit of carpentering I find that many succeeded in doing the feat in five pieces; some did it in four pieces, but few discovered the correct answer in three. The accompanying illustration conveys a pretty lesson in square root by showing that three squares containing 1 and 16 and 64 inches, when combined, should form a square of 81 inches with 9 on each side as shown:

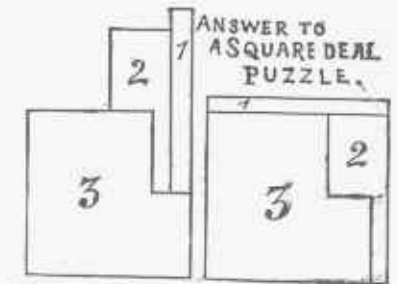

The Oriental love story tells of a broken pipe!

Answer to the Moon Problem.

By taking the best possible advantage of the crescent form of the moon, our clever puzzlists have succeeded in producing fifteen pieces of cream cheese for the hungry

mountaineers, as shown in the following sketch:

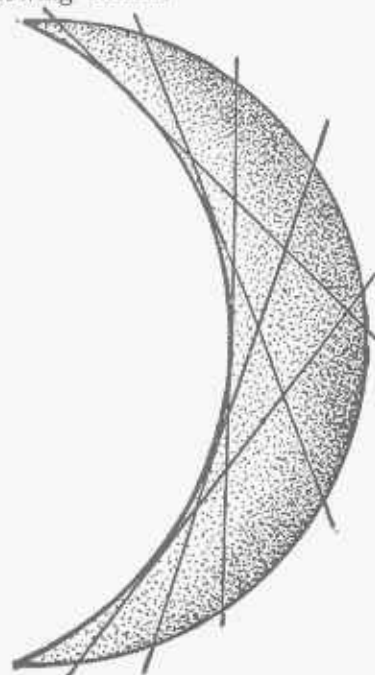

In the Moon Problem wherein Professor Sparwood undertook to reach the moon through the aid of a captive balloon, it was to give a common sense way of telling how many miles of wire one one-hundredths of an inch thick could be made out of a sphere twenty-four inches in diameter.

Well, all that is necessary is for the student to know that a round box termed a cylinder contains exactly one-half more than a sphere which it would hold, as shown in the illustration presented herewith.

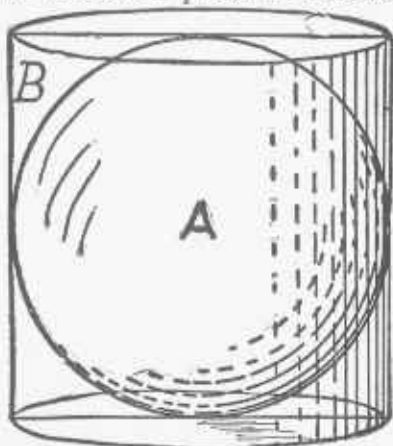

Therefore, if the sphere A is twenty-four inches in diameter, it occupies two-thirds of the interior of that hat box B, which is twenty-four inches high. Therefore, the ball would be equal to a cylinder two-thirds that height, viz., twenty-four inches in diameter, but only sixteen inches

high. That converts the ball into a cylinder, and as wire is really nothing but an extended cylinder, we readily find out the relative proportion between twenty-four inches and the one one-hundredth of an inch, as the one is 2,400 times larger in diameter than the other, so $2,400 \times 2,400$ gives 5,760,000 as the number of little cylinders one one-hundredth of an inch thick, contained in the big cylinder, and as they would be sixteen inches long, we multiply by sixteen and find that there would be 92,160,000 inches which will reduce readily to 1,454 miles 2,880 feet as the length of the wire.

The relative proportions of a sphere to a cylinder was discovered by Archimedes 380 years B. C., and was engraven upon his tomb to perpetuate to succeeding ages what the great mathematician looked upon as his most important discovery.

That high stepping kid was a soldier of metal because he was led! The Y was on the flag because it is the 4th of July! The 4th of July is like an oyster stew because it don't amount to much without crackers.

The Crusader's Puzzle.

In that remarkable trick of converting a Turkish flag into the Crusader's Cross, it is merely necessary to make a straight cut down through the center of the eight-pointed star to the extreme points of the crescent, then continue the cut around the inside of the circle and move the piece (A) to the left so as to get the following change:



Diamond and Rubies.

Having explained that diamonds increase in value according to squares of their weights, it was required to give the size of two small stones, which could be represented in value by two stones of different size, without employing fraction of a karat, and upon the assumption that a single karat stone is worth \$100.

The trade which gave rise to this puzzle and which struck me as being unique and interesting was the exchange of two five karat stones, worth \$2,500 each, viz., $5 \times 5 = 25$.

So the two stones were worth \$5,000, and were exchanged for a one-karat stone worth \$100 and a seven-karat stone worth (7×7) \$4,900, which shows the two-karat gems to be of the same value as the other two.

The Tinker's Kettle.

Taking 282 cubic inches as a one beer gallon, we have for 25 gallons 7,050 cubic inches. Then, by prismatic formula for obtaining volume of figures of proportionate ends (sum of areas of two ends plus four times area of middle section parallel to them, multiplied by one-sixth vertical height, equals volume, we have 12 inches, the vertical height, divided by 6 equals 2; and 7,050 divided by 2 equals 3,525, which is the combined area of the two ends plus four times the area of the middle section. Now, as the diameter of the top and bottom are as 2 to 1, the diameter of the middle section will be represented by $1\frac{1}{2}$ and areas will be in proportion of 4, $2\frac{1}{4}$ and 1; but as we take four times the area of the middle sections, the proportions, per formula, will be as 4, 9 and 1, or a total of 14, of which the area of the top represents $4/14$, and $4/14$ of 3,525 equals $1,007\frac{2}{14}$, the area of the top. Then, dividing $1,007\frac{2}{14}$ by $.785398163397$ and extracting the square root of the quotient to obtain diameter, we get 35.8096—which is the diameter of the top.

The Hoop Snake Puzzle.

Professor Von Schafskoppen gratefully acknowledges the valuable assistance of our puzzlists in mastering the difficulties of reconstructing that hoop snake.



Climbing the Greased Pole.

In this little problem which was given to afford the young folks an opportunity of exercising their ingenuity and common sense, it was told that the ambitious darkey would climb six feet in six minutes, but that at the end of every six-foot

climb he would slide back three while taking a rest. The height of the pole was to be guessed at or to be calculated according to facts or circumstances as shown in the picture.

Of course, a good many were completely nonplussed and saw no ground upon which to base their calculations. Among puzzlists, however, there was a wonderful unanimity of opinion regarding the height of the pole, which anyone with half an artistic eye would place somewhere between eighteen and twenty feet, without giving any other reason than the general effect of the shadows in the picture.

The idea of judging of the height of a tower or pole from the length of its shadow is well known. One of Sir Walter Scott's knights figured out the height of a tower with the aid of a ten-foot lance, but a clearer illustration of the principle is given in Conan Doyle's "The White Company," where Sir Nigel and his gallant comrades were locked up in a besieged castle:

"The grizzled archer took several lengths of rope from his comrades and knotting them together he stretched them out in the long shadow, which the rising sun threw from the frowning keep. Then he fixed the yew-stave of his bow upon end and measured the long, thin, black line which it threw upon the turf. 'A six-foot stave throws a twelve-foot shadow,' he muttered. 'The keep throws a shadow of sixty paces, so thirty paces of rope will be enough.'"

There is the secret of this little puzzle. All shadows in the picture will be in the same proportion to the heights of the objects which cast them. A plumb line from the finger tips of that sporting man will show that the shadows are to the scale of one-third the height of the objects. The pole, therefore, is three times as high as the shadow from center of pole to end of shadow line. We can then compute the length of that shadow from the fact that all trolley car tracks are four feet eight inches wide and we will readily find that the pole is nineteen feet eight inches high.

Now, remembering the fable of the frog in the well, we can allow for the various slips of the little darkey and will find that he gets a firm hold on the top of the pole in

just thirty-four minutes and forty seconds!

The Joiner's Problem.

This problem called for a solution in the fewest possible number of pieces; it will be seen that the best answer requires but two straight cuts and accomplishes the feat through the happy medium of turning one of the pieces over—a practical piece of carpentering which some of the followers of Euclid did not think of.

Whether the angle from D to B is more acute or less acute makes no difference. Draw the line from the center of the left side E to middle of the angle at C. Then draw the line at right angle, so as to hit the corner G, and the three pieces will form the square shown as Fig. 2.

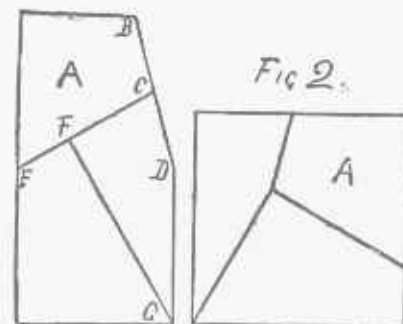

The Dutch Barber's Puzzle.

Many clever puzzlists and mathematicians got caught on at least one of the two catches presented in this new version of the old-line apple women's problem. In saying that thirty eggs were eaten during the first course of an Easter banquet, at the rate of three eggs per minute, would naturally require ten minutes, and to eat thirty more at the rate of two eggs per minute would be fifteen more, so that sixty eggs were eaten in twenty-five minutes. But during the third course, when sixty more eggs were consumed, first three in a minute and then two in a minute alternately, so as to again average five eggs in two minutes, those who know the mathematics of the situation can see that five eggs in every two minutes would consume the sixty eggs in twenty-four minutes, so the entire dozen eggs would be eaten in exactly forty-nine minutes!

But the Dutch barber wanted to know "how long it would have taken to eat those ten dozen eggs if there had been but half as many guests at the banquet?" The mathemati-

cians fell into the mistake of saying that if the eggs were eaten in forty-nine minutes, half the number of guests would have required twice the time, viz: ninety-eight minutes. It took the clever puzzlists, however, to discover that the eggs, which must have been very small ones, were all eaten by one person! It was a very exclusive banquet with but one guest! So half the number of guest could not have eaten the eggs at all! Take the time as stated: Thirty eggs in ten minutes, then thirty in fifteen and sixty in twenty-four, and you can plainly see that but one egg was being eaten at a time, and as it was said they were eaten without intermission, it would require but one person to do the job!

More than one person could not conform to the terms of the problem. The last sixty eggs were eaten first three in a minute and then two in a minute. How could two persons eat three eggs? Or how could three persons eat two? There is no number which will divide into two and three, except one!

Answer to Tower of Pisa Puzzle.

Ninety-nine per cent of our puzzlists and mathematicians fell into the popular error of confounding this puzzle with the famous race between Achilles and the tortoise, and pronounce the problem to be unsolvable. Skilled mathematicians give approximate solutions and show that by the use of decimals carried out to considerable length the answers will be less than the billion billionth part of a hair.

It can be shown, however, that an elastic ball, dropped from the top of the tower, a distance of 179 feet, and which continues to rebound one-tenth of the height of each fall, will come to a rest after traveling 218 feet 9 inches and one-third.

Many make the mistake of supposing that $218.777777+$ would be a more accurate answer. If the row of sevens were carried out to a billion billion decimal points it would not be so accurate as that nine and one-third inches.

If a ball dropped from the extreme top of the tower fell half of the distance in the last second, would prove the tower to be 187.4806 feet high.

The Rebus word is Myriad.

The Bridges of Konigsberg.

There are 416 ways of doing this trick of which the shortest route is

via O-P, D-C, E-F, H-G, I-F, L-K, N-M and A-B, but as there are several million ways of not doing it, such a small matter as 416 routes may have been overlooked.

The Andre captors came from Dresden.

The General-Store Puzzle.

I find that algebra is more popular with our puzzlists than is generally supposed, and they found no trouble whatever in adding up bow-wow chops, Alsop's pale ale and cow's cheese so as to make it all wool. To such—if any there were—who could not solve the mystery which has puzzled me all these years, it may be stated that the keyword to the situation is "peach blows," a most popular variety of potatoes. Give each of these letters a number, running from 1, 2, etc., to 0, and it becomes an easy matter to discover the algebraic value of hoes, apples, soap, etc., the total of which adds up "all wool," which, to say the least, is a remarkable coincidence.

The Red Cross Puzzle.

The following illustration shows how the Greek cross may be cut into five pieces which will form two crosses of the same size. Cut as shown in Fig. 1, and rearrange the small pieces as shown in Fig. 2.

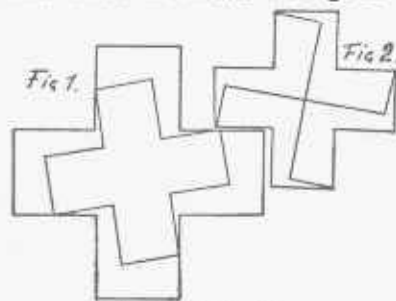

False Weights.

In regard to the puzzle of the broker in camel's hair who used a pound weight of seventeen ounces when buying and sold with a fifteen-ounce weight, so that he made \$25 by cheating in addition to his two commissions of 2 per cent., it may be said that the ordinary methods by algebra or ratio and proportion seemingly fail to give a satisfactory answer, so I will attempt to give a plain, common-sense explanation, based upon simple arithmetic.

In the first place, if the broker weighed the goods with a pound weight one ounce too heavy, he got 17 ounces for a pound. When he sold them by a weight one ounce light he gave 15 ounces for a pound,

and had two ounces over. If these two ounces were sold at the same price, so as to make \$25 by cheating, it is plain that the two ounces represent 2/15ths of what he paid for the whole and charged for the 15 ounces. One-fifteenth being worth \$12.50, fifteen-fifteenths, or the whole, would be \$187.50, which, if there was no question of commission, would be what he paid for the goods.

We find, however, that he received 2 per cent. from the seller, \$3.75, and \$4.25 from the purchaser, making \$8 brokerage in addition to \$25, by cheating. Now, if he had dealt honestly, he would have paid for 17 ounces, which, to be exact, would have been \$199.21875. His brokerage for buying and selling would therefore only be \$7.96875, so he has made an additional 3 3/8 cents by cheating. As the story said that he made exactly \$25 by cheating, we must reduce the \$187.50, price so that his two cheatings will amount to just \$25.

Now, as 3 3/8 cents is exactly the 801th part of \$25.03125, we must reduce \$187.50 by its 801th part, which will bring it down to \$187.27, so that he will make just \$25 and the .0006 of a cent by cheating. To such as wish to be very exact and honest, I would suggest that the seller be paid \$187.2659176029973125 less the 2 per cent. brokerage of \$3.745 plus.

City Hotel Puzzle.

Mary Ann was mother to the sick boy!

Football Puzzle.

The cubical area of the ball may be considered as made up of a great number of small pyramids, with apexes meeting at the center of the ball, and their bases representing the surface. We know that the volume of a pyramid is equal to its base multiplied by one-third of its height. Therefore, the volume of the sphere is equal to the sum of the bases multiplied by one-third of the constant height, viz: The surface of the sphere multiplied by one-third of the radius. If this volume is to be equal in number to the surface, it follows that one-third of the radius is unity; therefore, the radius is 3 and the diameter of the ball 6 inches.

Plato's Cubes.

The majority of our mathematicians, who were to a certain extent familiar with the subject, which it is plain to be seen calls for geometri-

cal numbers which can be squared or formed into a cube, hit upon the elementary combination of 4, viz: 4x4x4 makes a cube containing 64 cubes. This monument, therefore, might readily be placed in the centre of a square plaza of 8x8 cubes, also containing 64 cubes. Puzzlists, however, who know that the picture cuts an important figure in the puzzle, saw at a glance that the dimensions just described would not build a monument and plaza of the proportions shown in the sketch.

They, therefore, suggested a higher series of numbers, and found that 9x9x9 would form a square monument containing 729 cubes. This same number of cubes could be arranged in a 27x27 plaza which gives the correct dimensions as shown in the picture. Of course the multiples of these numbers could be employed, but 729 cubes is the only number below 1,000 which would fill the bill.

The Monastery Puzzle.

Our clever puzzlists who were familiar with the ancient couplet:

"Persevere ye perfect men,

Ever keep these precepts ten," found no difficulty in reading one of the "precepts ten" so shown in the window. It is translated to be C on T in U in hole in S, which may be read: "Continue in holiness."

Answer to the Cat Puzzle.

Many good mathematicians fell into the error of attempting to solve Alice's cryptogram of "Was it a cat I saw," upon the basis of there being twenty-four starting points and the same number of endings. They reasoned that the square of 24, viz: 576 different ways, would be the correct answer. They overlooked the branch routes which give exactly 252 ways of reaching the center, C, and as there are just as many ways of getting out to the Ws, the square of 252 gives the correct answer as 63,504 different ways.

How we knew that Annapolis was the hidden city!

The Steeplechase.

Our puzzlists and mathematicians have had a hot race to the finish in that steeple chase puzzle. It was told that the sketch showed the judges' stand to be at the opposite end of a rectangular field, bounded by a road of a mile long on one side by three-quarters of a mile on the other. By the road, therefore, it would be a mile and three-quarters, which could be run in three minutes-

Uniform Price Puzzle.

My friend, who was explaining the "uniform price" system of doing business at the Klondike, showed me that the price of one dollar for a quart of liquor was the key to the whole situation, and gave the price for all of the other articles in the window. The lady's side saddle would be worth \$4, as it holds a "gal on." The anchor would be worth \$40, because in wine measure an anker holds ten gallons. The hogshead would be worth \$252, as there are that many quarts to a hogshead, and the pipe would be worth twice as much, as there are 504 quarts to a pipe.

Great Columbus Puzzle.

The secret of winning in a contest to see who can place the last egg upon a square napkin as described in the Columbus puzzle, turns upon placing the first egg exactly in the center of the napkin, as shown in the square diagram. Then, no matter where your opponent places an egg, duplicate his play on the opposite in a direct line through egg No. 1. The numbers given illustrate the beginning of the game, proceeding in regular order of play, viz.:

1, 2, 3, 4, 5, 6, 7, 8, 9, etc.

The placing of the first egg in the center would not win, if simply laid on the table, for, owing to the oval form of the egg, the second player might place an egg in close proximity to the conical end, as shown in the last illustration, which could not be duplicated.

The only way to win, therefore, as discovered by the great navigator, according to popular history, is to flatten one end of the first egg played

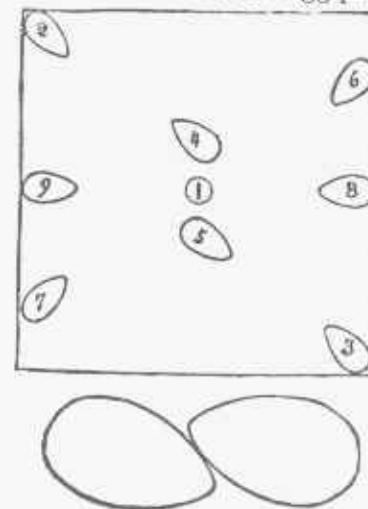

They were at liberty, however, to cut across lots at any point, but owing to the rough ground would run 25 per cent. slower. By starting down the mile course and going a little over the eighth of a mile, and then taking a cut across lots to the finish the race can be won in 2 minutes and 51 seconds plus, which is somewhat better than by starting off on the hypotenuse line at once.

"Grandfather's Clock" Puzzle.

"The clock stopped short, Never to go again

when the old man died."

It was explained that the hour and minute hands had tangled up, and the puzzle was to determine their point of contact from the position of the second hand. Well, as the second hand may be said to be a little less than 5 1/2 seconds past 60, we will find that the time must have been 49 minutes, 5 and 5/11ths of a second past 9, which would bring the hour and minute hands together so that they caught and stopped the clock, which so irritated and excited grandfather that he just "up and died."

Hands off of that tiger which is on exhibition at Bangor.

The Switch Puzzle.

The problem is solved in thirty-two moves, as follows: First engine F passes alone through the switch via C, B, A (two moves), pulls engine E to D and once more passes through switch via C, B, A (total, five moves); pulls car D to D, pushing E out to right; passes again through switch (eight moves); pulls G to D, pushing others out to right, engine goes through switch again (eleven moves); pulls B to D, and passes through switch as before (fourteen moves); pulls A to D and passes through switch for the last time (seventeen moves); goes to right, then draws A, B, C, D, E, G to left and backs G onto switch (twenty moves); draws A, B, C, D, E to left, backs them to right (twenty-two moves); goes to left alone, backs up on switch at A and takes G to left (twenty-four moves); goes to right, then pulls everything out to left, backs H, I onto switch (twenty-seven moves); pulls G, A, B, C, D, E out to left, backs them to right, then takes F to right and backs up to switch and connects G to H, I (thirty-one moves), and is now prepared to go ahead on the thirty-second move.

so as to make it stand erect, so as to represent a circle.

This puzzle, as previously explained, was not given for practical demonstration, but just to develop the gray matter in the brain.

Lost Opportunities.

Every one of our young lady correspondents voted Cholly Slowpop a mutton head for his explanation of the sweetness of stolen kisses, and the stupid answers to those easy conundrums. Of course he should have replied that they were like that tempting fruit because they were such a "nice pair." If, when she had asked him what kind of animals fell from the clouds, he had replied "reindeer," the atmosphere would have been less chilly during the ride home.

That drifting scene hides the name Arno.

Dividing the Spoils.

The correct answer is that Nellie, who was 4 1/2 years old, got 198. Mary, who was 6 years of age, got 264, and Susie, who was 7 years old, took 308.

The analysis of the problem shows that as Susie gets 7 to Mary's 6, and that Nellie gets but 3 to Mary's 4, she would get just 4 1/2 in each division of 4, 5, 6 and 7, which amounts to 17 1/2, so by dividing the 770 chestnuts by 17.5 we get 44 as the number to multiply the ages by to tell how many chestnuts each received. Mathematically speaking, the divisions and proportions would be correct if we gave the ages as 9, 12 and 14, or any other of the multiples of 4.5 and 6 and 7 years, but as a glance at the picture would show that the ages would not correspond to the little girls as shown, those answers would not be correct, according to puzzle principles.

The Grindstone Puzzle.

Our Syrian friends could get the approximate number of square inches contained in a circle of 22 inches diameter; from this they would deduct the number of inches contained in the 3 and 1/7 hole. Then they would figure out the approximate size of a circle containing half of the number of square inches, which would be the size of the grindstone when the first man is done with it. The only perfect method, however, is based upon our demonstration that the area of circles may be computed from the

squares of their diameters. Knowing from our Pythagorean problem, that a square drawn within a circle would contain another circle just half the size of the larger circle, let us take the grindstone, and after drawing the lines A to C and B to D, build the square, A, B, C, D; then draw the circle, E, just within that square, and it contains exactly one half the area of the large circle.

Having stated, however, that loss from the centre hole must be divided between the two owners of the grindstone, we draw a square inside of the circular hole, and inside of that small square describe another small circle, which is just half the size of the circle, F. We will now work the Pythagoras rule for adding circles, and place the small circle at G, and the line from H to I will form the hypotenuse line of a right-angled triangle, which gives the diameter of a circle, combining the area of the circle E and the smallest circle, which is half of F. This enlarges the circle E, so that the dotted line shows a circle which contains exactly one-half of the grindstone, and will have a diameter of 15 5/7 inches.

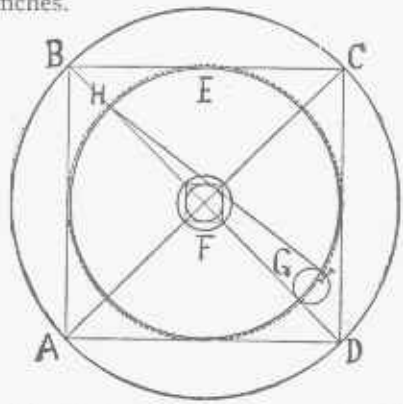

Hoch der Kaiser conceals the name Berlin.

One Cent Shy.

In that simple little study in United States coins, wherein the conductor happened to be one cent short to change the dollar bill, it will be found that he must have had a fifty-cent piece, two twenty-cent pieces, a three-cent and a one-cent piece. As the smaller coins are of different sizes, he could not have had two two-cent pieces as some supposed.

One thing at a time occurred at "Lowes."

The Oracle Puzzle.

To that mystic reply of the oracle which told the peasants their flocks

would increase "until the number of sheep multiplied by the number of goats would show a product which when reflected in a mirror would show the number of the entire flock," it may be said that the peasants, as well as some of our puzzlists, experimented before a mirror until they hit upon the number of nine sheep and nine goats. $9 \times 9 = 81$, which held before a mirror, becomes 18, which would be the total of the flock.

That neck-tie puzzle reads, "It was the season for bass, but with such heavy seas on they caught none."

The Sedan-Chair Puzzle.

In that odd little cutting puzzle, where it was required to divide the sedan chair into the fewest number of pieces which could be fitted together so as to form a perfect square, the following line shows how several of our clever puzzlists perform the feat in only two pieces:

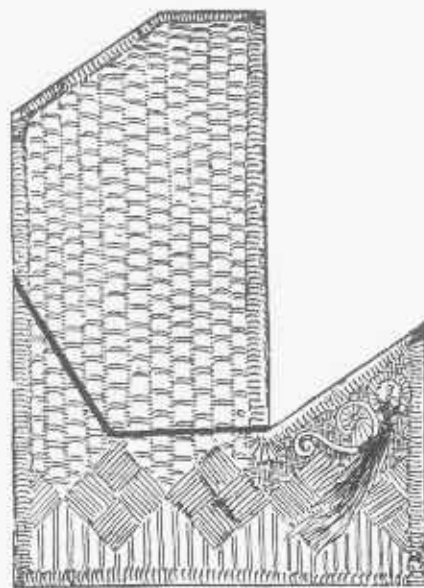

Barnum brought Jumbo from "Boonton."

The Chinese Switch-Word Puzzle.

In this little switch-word puzzle, which was built upon similar lines to the old star puzzle, I took occasion to explain the principle of such puzzles, and, incidentally, to give a good tip regarding the nature and character of the word which, according to my own analysis, would furnish the best key to the Chinese mystery. In the original Chinese switch-word puzzle they use a sentence of twelve words, as in the Chi-

nese language every word is represented by a specific sign word, but in the present Americanized version of the puzzle it was explained that the sentence must be translated or represented by a twelve letter word, one letter on each block—so I introduced the portraits of two interpreters translating the word. The puzzle being to change the position of the block, by sliding them like the old 14-15 puzzle, in the fewest possible moves, so that the word would read correctly from left to right, instead of from top to bottom.

Many clever and ingenious answers were received, giving all manner of twelve-letter words, and varying in from thirteen to twenty-five moves, but few solvers caught on to my intimation that there was a peculiarly appropriate word, or who took their "queues" from the Chinese interpreters, hit upon the lucky word "interpreting" which runs it right off the reel in twelve plays without any "drilling," as the railroad men term it.

More trouble is located at "Corea."

The Good Luck Puzzle.

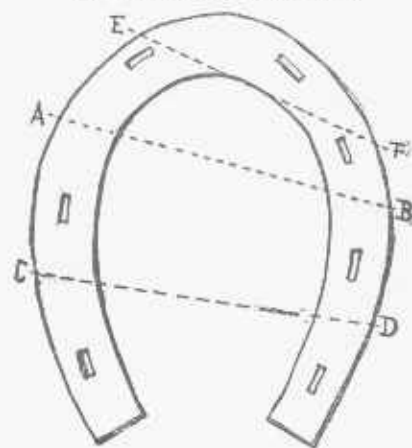

The Dog's Head Puzzle.

The following cut shows the way of dividing the head in two equal halves.

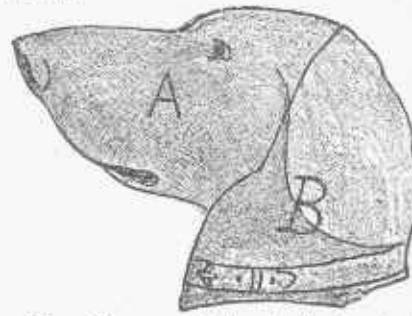

The kings of the turf lived in Alexandria.

In Fritz the Barber's problem there are eleven positions where the minute hand will take just fifteen minutes to get as far ahead of the hour hand as it was previously behind it, but as there would be but one position which conforms to the position of the second hand as shown in the picture, and where the hands cannot be seen, so the only answer would be that he began at 10.47 and 2 and 8-11 seconds, and ended at 11.2 and 2 and 8-11 seconds.

CONCEALED GEOGRAPHY. 85. Rathisbön, 86. Briston, 87. Cowes, 88. Normandy, 89. Albania, 90. Ostend, 91. Liege, 92. Ghent, 93. Madawaska, 94. Labrador, 95. Grenada, 96. Iowa, 97. Meuse, 98. Lyons, 99. Acre, 100. Siam, 101. Iser.

The weary traveler started from Erie.

In the problem of the pyramids it is evident that if the lion goes seven steps, the guide six and the tourist five, $7 \times 6 \times 5$ gives 210 as the number of steps, which would bring them out together at the top. As the lion is five steps shy in the sketch, the guide three and the tourist one, we can readily see that the pyramid must be 201 steps high to bring about the tableau shown.

Hidden city, Finland.

In regard to the crop of cabbage heads Mrs. Wiggs takes occasion to explain that by dividing the increase 211 as nearly as possible in halves, the squares of those two sums will show the relative dimensions of the two patches, namely, 105×105 gives 11,025 as last year's crop, and 106×106 equals 11,236 as this year's crop, with an increase of 211 cabbage heads.

False keys were heard at Sing Sing.

That autobiography of a silver quarter of a dollar tells of its being stamped in 1853 and *re-fused* when it was worn smooth.

Concealed Geography 1. Constantinople, 2. Samaria, 3. Thebes, 4. London, 5. Sedan, 6. Tours, 7. Metz, 8. Inkermann, 9. Edinburgh, 10. Bergen, 11. Genoa, 12. Balkan, 13. Berlin.

Bingham was in Utah.

The horseshoe on the door puzzle may be solved poetically as follows: With a golden horseshoe nailed over the door,

Many tradesmen made fortunes in this famous store.

First came the tailor on whose sign was writ PANTS,

Next a dealer who in PINTS saw his chance.

A florist then followed with a choice lot of PINKS.

Which in turn were displaced by a furrier's MINKS.

After this a jeweler selling LINKS made his pile,

But the plumber with his SINKS beat him a mile.

SILKS were the source of the dry goods man's wealth,

And the carpenter did not make SILLS for his health.

The druggist sold such a great lot of PILLS

That his successor, the notary, kept busy writing WILLS.

The mason built WALLS and a fortune, too.

While the undertaker made PALLS for Gentile and Jew.

When the grocer moved in he made money in PAILS,

Then made room for the chandler to spread out his SAILS.

NAILS proved a boon for the hardware man—

And that is as far as old records ran, But if "Old Abe" ever occupied that store,

He surely must have sold RAILS galore.

That Gordian Knot Puzzle.

Our puzzlist readily discovered by actual practice that the scissors may be removed from the string by working the loop backwards along the double cord. First down on the left side, up through the center, down the left, up center, down left and then pass the scissors through the loop, and they will come off if you have not produced an unfortunate tangle by twisting the cord.

Regarding the problem of Bidy's wedding day, it can be shown that the happy couple will celebrate their tenth anniversary on next St. Patrick's Day. "When a week ago last Tuesday was to-morrow" it must have been Monday, Feb. 17, 1896, and when Bidy said, "When a day just two fortnights hence will be yesterday," she was talking about St. Patrick's Day, March 17, 1896, as no other day would fill the bill except 1868, in which case they would now be thinking of a golden celebration.

Concealed Geography 102. Annapolis, 103. Arles, 104. Oregon, 105. Chester, 106. Pan, 107. Gath, 108. Maine, 109. Hague, 110. Utica, 111. Boston, 112. Omaha, 113. Glasgow, 114. Utah, 115. Dan, 116. Dan, 116. Stoneham, 117. Syria, 119. Parma, 120. Milan, 121. Perugia, 122. Magdeburge, 123. Cyprus, 124. Leeds, 125. Candia, 126. Corea, 127. Goshen, 128. Greece, 129. Berne, 130. Georgia, 131. Pultora, 132. Macon.

Answer to Chicken-in-the-Corn Puzzle.

The real point of this puzzle is that, play as you will, the "man" could never catch the "rooster" nor the "woman" the hen," for, as they say in chess or checkers, the rooster "has got the move" on the man, and for the same reason the woman can never get the "opposition" on the hen. But if they will reverse matters the answer is very simple—the man can catch the hen in nine moves and the woman will catch the hen in eight. The principle can best be shown on a checkerboard: First move the man toward the woman, and the woman toward the man. Both birds move, following their would-be captors. Now move the man down one square and move the woman to the square above him. After that transposition has been effected the continuation is simple. The birds each move and are closely pursued until captured.

Lincoln's Rail Problem.

To solve the problem, draw the circle with a pair of compasses, and remembering that invaluable rule that the distance from the center, called the radius, will always divide a circle into six equal parts, mark it off into six equilateral triangles, as shown. We will then triangulate it once more by introducing the intermediate distances from A to B, and from B to C, etc., which represent our 16-foot rails. From this we can readily compute that the distance from C to B is 30 feet 11 inches, and as from A to D is just half as long, any puzzlist will speedily discover that the triangles X X can be fitted with the triangles Y Y to form one oblong 30 feet 11 inches by 15 feet 5 1/2 inches. Thus 477 3/4 feet represents just one-sixth of the area of the entire field, 2,866 1/2 square feet being the correct answer.

NOW AND THEN conceals the name Amherst.

The Merchant of Bagdad.

The number at the end of a paragraph denotes the number of manipulations in that paragraph.

The hhd. contains 63 gall. water, and the barrel 31½ gall. honey. Fill the three 10-gall. bottles with honey, pouring remaining 1½ gall. into 2-gall. measure, thus emptying barrel (4).

By means of the 4-gall. measure fill barrel from hhd., eventually leaving ½ gall. in 4-gall. measure. Give this ½ gall. to camel No. 1. By means of 4-gall. measure return 28 gall. of water from barrel to hhd. Pour 1½ gall. honey from 2-gall. measure into 4-gall. measure. Pour 2 gall. water from barrel into 2-gall. measure and return to hhd. Draw off remaining 1½ gall. water from barrel into 2-gall. measure and give this to camel No. 2. Pour 1½ gall. honey from 4-gall. measure into 2-gall. measure (37).

Repeat the whole of the operations in last paragraph 11 more times, so that 6 camels shall have each received two ½-gall. drinks, and other 6 camels two 1½-gall. drinks. But on the 10th and 11th repetition, instead of returning the 2 gall. to hhd., deliver them to any two camels who have already received two ½ gall. only. Eight camels have now received 3 gall. each, and four camels 1 gall. each, and there will be 35 gall. water in hhd. (407).

Fill barrel from hogshead, using 4-gall. measure and give ½ gall. over to camel No. 13. Draw 3 gall. in hogshead into 4-gall. measure (18).

Return all honey to hogshead. Empty barrel into 3 10-gall. bottles, and draw remaining 1½ gall. into 2-gall. measure. Return contents of 3 bottles to barrel, and pour 1½ gall. from 2-gall. measure into bottle No. 1 (12).

Fill the 2-gall. measure from 4 gall., leaving 1 gall. in 4 gall. Fill barrel from 2-gall. measure, and give remaining ½ gall. to camel No. 13. Give 5 camels 2 gall. each, all the camels having now been served (13).

Fill the 2 empty bottles from barrel, and draw remaining 1½ gall. into bottle No. 1. Return contents of bottles Nos. 2 and 3 to barrel (5). "A."

Pour 1 gall. from 4-gall. measure into No. 2 bottle. Put 6 gall. honey in bottle No. 3, using 2-gall. and 4-

gall. measures. Empty the 1 gall. from bottle No. 2 into 4-gall. measure, and fill up that measure with honey from bottle No. 3. Pour contents of 4-gall. measure into bottle No. 2. Draw 2 gall. water from barrel and put into bottle No. 2 (10).

The 13 camels have now each received 3 gall. of water, one of the 10-gall. bottles contains 3 gall. of water, another 3 gall. honey, and the third 3 gall. of honey and 3 gall. of water mixed. The hogshead contains 25½ gall. of honey, and the barrel 18 gall. of water, while the total number of manipulations is 506.

Answer to Going Into Action.

In this naval problem, wherein it was required to show the fewest possible number of moves whereby Uncle Sam's battleship could run down and destroy the sixty-three vessels of the enemy, it may be said that there are many simple ways of performing the feat in from fifteen to eighteen moves, but the following plan in fourteen moves, returning to starting point, seems to be the best possible answer:

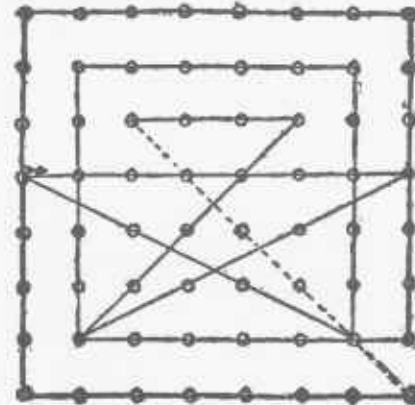

Answer to the Lip-Reading Puzzle.

Out of the thousands of persons who were interested in the scientific feature of that curious lip-reading puzzle the ease and unanimity with which they picked out little Matthew as the first boy on the top row encouraged them to tackle the next, and by a large majority Matthew, Alfred and Eastman were located on the top row, Richard, Theodore, Luke and Oom on the second row, with Hisswald, Shirmer, Fletcher, Arthur and Alden below. From the many correct answers received it would appear to be an easier feat to read the motion of the lips than one would suppose.

THE BIRD CATCHER lived in Erin.

In weighing the baby the scales show their combined weight to be 170 pounds, and as Mrs. O'Toole weighed 100 pounds more than the combined weight of the dog and baby, she must have weighed exactly 135 pounds. As the dog weighed 60 per cent. less than the baby, we can readily see that the baby weighs 25 pounds and the dog but 10 pounds. All of which is very simple when you know it.

In that match trick the nine matches are laid in the form of letters so as to spell TEN, while Harry is expected to spell NIX.

Concealed Geography.

Concealed Geography—54, Venice; 55, Remina; 56, Senegal; 58, Berlin; 59, Corinth; 60, Bath; 61, Calcutta; 62, Elba; 63, Lansing; 64, Malta; 65, Tarragona; 66, Peru; 67, Italy; 68, Versailles; 69, Onaida.

Those chattering monkeys hide the name Albany.

The New Star Puzzle.

The accompanying diagram shows how the French astronomers would locate the new celestial find which proves to be of such heroic dimensions as to cast the other little stars quite in the shade.

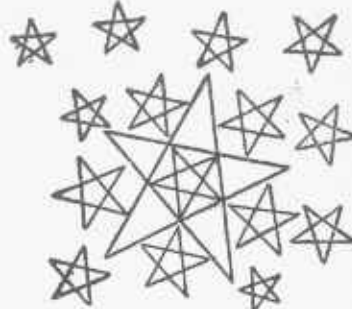

THE CLEVER COIN TRICK is answered as follows:



In that instructive visit to the zoo, our young friend readily computed that if there were one hundred feet and thirty-six heads among the horses and riders, there must have been fourteen horses and twenty-two riders. Also, as it was told that there were fifty-six feet and twenty heads among the curiosities, and we can see ten animals and seven birds in the picture, it is plain that only three more curiosities are to be accounted for, which can have but two feet and three heads among them, so it does not require a vivid imagination to surmise that the attraction in the cage which absorbs so much attention must be the wonderful Hindoo snake-charmer with her two serpents.

THAT TURKEY weighed just 24 pounds, which would cost therefore 16 times 24, or \$3.84. Dr. Shylock played a trick on the butcher by weighing the turkey on his own scales, whereby in troy or apothecary's weight, it would weigh but 350 ounces instead of 384, as claimed on the butcher's scales.

The unsophisticated butcher stood the loss of 34 cents, and to show that he had no ill feeling ordered as many pounds of rock salt at 3 cents a pound as he had sold ounces of turkey.

The doctor thought that if he beat the butcher on ounces he would also get ahead of him on pounds, weighed out 350 pounds of salt, which, according to his own scales should be worth \$10.50, but when he re-weighed it, as per agreement, on the butcher's scales, 350 pounds troy only weighs 288 pounds (avoirdupois) on the butcher's scales, therefore the butcher gained 62 pounds of salt at 3 cents a pound, which would be worth \$1.86 to offset his loss of 34 cents on the turkey. So the answer to the problem is that the butcher comes out \$1.52 ahead on the whole deal.

Heard at the Zoo.

In that complicated bit of octamal arithmetic, wherein it was asked to write the year 1902 in a system of notation which only employs the first eight digits, it may be shown that the answer would be 3556. This sum represents six units, five 8's, five 64's and three 512's. To produce the answer, first divide 1902 by 512. Then divide the remainder by 64, and what is left by 8, and we get the answer as given, 3556. If we

wished to describe 1902 by the septimal system, we would divide 1902 by the multiples of 7, viz., first by 343, then the remainder by 49, and what is left by 7. We get the answer 5355, which represents five 343's, three 49's, five 7's and five units.

Answer to Christians and Turks.

This puzzle is just the reverse of the ordinary story of the Turks who were thrown overboard, as in that problem the point is to arrange the men in a circle so that every thirteenth man would be a Turk, while in this puzzle the question was to find the best number as well as the correct starting point, to count out all the boys.

As discovered by some of our clever puzzlists, the solution is obtained by commencing the count with second girl from the left in the upper part of the circle, and, counting her as No. 1, continue to the right counting off every thirteenth one. This method will count out all the girls and the boys will be "left," but if you wish to count out only the boys, so the girls will be left, use fourteen in place of thirteen, so that by picking out every fourteenth boy, they would have got the pennies and Tommy Muttonhead would have escaped the licking.

Red Cross Volunteers.

The Red Cross puzzle showed how to make two crosses of the same size, so we will now make two crosses of different sizes:

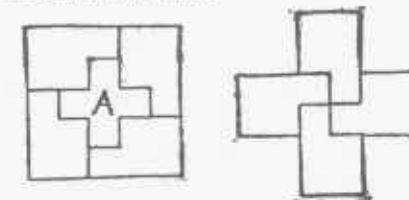

Riding Against the Wind.

Contrary to the popular answer to problems of this kind, that if a rider goes a mile in three minutes with the wind, and returns against the wind in four minutes, that 3 and 4 equal 7, should give a correct average, so that his time should be taken to be 3½ minutes. We find this answer to be incorrect, because the wind has helped him for only three minutes, while it has worked adversely for four minutes. If he could ride a mile in three minutes with the wind, it is clear that he could go a mile and a third in four minutes, and one mile in four minutes against the

wind. Therefore two and one-third miles in eight minutes gives his actual speed, because the wind helped him just as much as it has retarded him, so his actual speed for a single mile without any wind would be 3 minutes and 26 seconds.

Old Saws With New Teeth.

In the following diagram Fig. 1 shows the popular way of solving this old puzzle according to the puzzlebooks. This would divide each of the oval rings into four pieces, as shown in Fig. 2. According to our recently-discovered method, which introduces the Chinese Monad sign, as shown in Fig. 3, the feat can be performed with six pieces instead of eight.

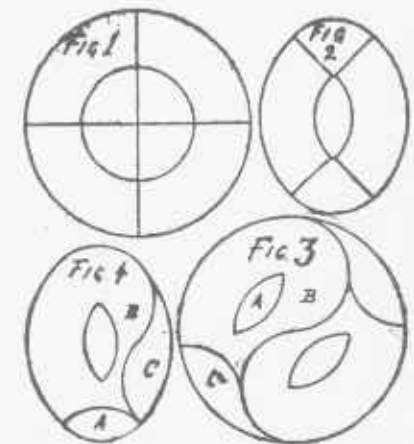

Keen Wit.

In the juvenile puzzle wherein the object was not only to discover the locality of the incident, but to explain the meaning of the jolly Hibernian's sarcasm, it may be said that our young puzzlists readily located the incident as concealed in the sentence: "Begora, Mr. P. (hiC) (HIC) A GOod batin ye'd get if I could get in yer cage!"

Everyone, however, did not appreciate the subtlety of his addressing the nine dummy tailors as one man, nor his slurring intimation that Mr. Shaw's name should be spelled "Pshaw!" to say nothing about his criticism of Mr. Shaw's grammar in saying that he and not his goods could not be beaten.

Old Style Enigma Ans.

My whole is now before you. HIDDEN CITY—Hartford. That apple tree conundrum is because the tail is farthest from the bark.

Santos-Dumont's Balloon.

Almost every one, mathematicians as well as puzzlists, fell into the common error of supposing that the wind would average up even, as would be the case if we went ten minutes with the wind and ten minutes against it, when it holds in one direction just as much as it retards in the other, while in the case cited it helps for only ten minutes and retards for a whole hour. It is a simple matter to find that the wind was blowing at the rate of a mile in 4 minutes and 48 seconds, and that the propelling speed of the flying machine is 3 and 9-21sts of a minute per mile, so that he would cover the ten-mile course in a calm in 34 minutes, 17 and 1-7 seconds. The problem was given as a puzzle for the mathematicians who failed to note the palpable error in the description of the time actually made by Santos-Dumont.

Railroad Lingo Puzzle.

Such of our readers as are up in railroad lingo readily interpreted the conductor's statement that the train would stop four minutes, 222222! to mean that there would be a four minutes' stop, and that the time, in railroad lingo, would be two to 2, to two 2, which means two minutes to 2 until two minutes past 2. It is no wonder, however, that Mandy thought the conductor was trying to imitate an engine with his "chu, chu, chu, chu, chu, chu!"

Dividing His Flocks.

In that curious story of the Western ranchman who divided his herdy among his sons and their wives, it will be found that he had seven sons, fifty-six cows, and, as shown in the picture, just seven horses. The eldest son took two cows and his wife six, which was one-ninth of the remainder. The next son received three cows and his wife five. The next son four and his wife four, and so on down to the seventh son, who took eight cows, which left none for the wife. Then each son took one horse, so every family received eight cows and one horse and all shared just alike.

THOSE LUCKY BOYS found three 5s, three 25s and a \$3 gold piece which they threw in the well.

Heiro's Crown.

Archimedes was a Greek Hebrew of pronounced business proclivities, who had many dealings with the ruling potentates who were wont to put

their crowns in soak found the following results: Weighed in the air the crown was exactly 63 ounces, but weighed in the water, as shown in the picture, it had displaced 8.2245 cubic inches of water, which was readily determined by its difference in weight, as it was well known that a cubic foot of water containing 1728 cubic inches, weighed 62.5 pounds. Thereupon any articles will weigh less in the water, just in proportion to its size, or the amount of water it has removed, irrespective of its shape.

It was known that a cubic inch of pure gold carefully tested, weighs exactly 10.36 ounces, and that a cubic inch of silver but 5.85 ounces, being not much more than half the weight of gold. Therefore it becomes a simple matter to calculate the composition of an alloy which weighs 63 ounces and represents 8.2245 bulk.

8.2245 inches of gold would weigh over 85 ounces and we know that the crown weighed but 63, so quite an amount of silver had been introduced. 8.2245 of silver would weigh but a little over 48 ounces, so it is plain that the jeweler did use some gold. A puzzlist would say, suppose half of quantity was gold, we would have 4.11225 inches of gold and 4.11225 inches of silver which by simple multiplication, is found to weigh 66.6595725 ounces, which should be but 63.

Then says the puzzlist, let us say that one-third of the quantity was gold, and we find that 2.7415 inches of gold weighs 28.401940 ounces, which leaves 32.075550 ounces of silver (viz. 5.4830x5.85), which weighs but 60.477490 ounces instead of 63. From these two trials the first of which was too rich in gold and the other too poor, we at once strike the happy medium and find that 34.1964 ounces of gold and 28.8036 ounces of silver weigh 63 ounces and fill the space of 8.2245 ounces!

The gold at \$21 per ounce would be worth \$718.1244, which, with \$17.570196 for the silver, at 61 cents an ounce, would make the crown as finished worth \$735.694596, whereas the 63 ounces of gold would be worth \$1323, so the dishonest jeweler really stole about \$587.30.

That Hod-Carrier's Problem.

In the puzzle wherein it was asked to tell how many steps the man must take to go up and down, up twice

to the top and twice to the ground and twice on every step, it may be briefly stated that the feat can be performed in nineteen steps, as follows: First go to step 1, then back to ground, and proceed by the steps 1, 2, 3, 2, 3, 4, 5, 4, 5, 6, 7, 6, 7, 8, 9, 8, 9. Every step has been used twice and the ground as well as the top has been reached twice.

Crossing the River.

In that complicated puzzle of the summer tourist who had to cross the stream in a boat which would hold but two, and where certain personal feeling added to the difficulties of the strained relations, it can be shown that the entire party can be ferried across the stream in seventeen trips as follows:

- First—Mr. and Mrs. C. cross over.
- Second—Mr. C. returns alone.
- Third—Mr. C. takes over a lady.
- Fourth—Mr. C. returns with his wife.
- Fifth—Mr. C. takes over another lady.
- Sixth—Mr. C. returns alone.
- Seventh—The two gentlemen cross over.
- Eighth—Gentleman and wife return.
- Ninth—Mr. and Mrs. C. cross over.
- Tenth—Gentleman and wife return.
- Eleventh—Two gentlemen cross over.
- Twelfth—Mr. C. comes back alone.
- Thirteenth—Mr. C. takes lady over.
- Fourteenth—Mr. and Mrs. C. return.
- Fifteenth—Mr. C. takes lady over.
- Sixteenth—Mr. C. returns alone.
- Seventeenth—Mr. C. and wife go over and the entire party have been transported to the other side.

Used to Kissing.

The story describes two billiard balls!

In that problem of dickering for rope at Manila, it was told that the dealer measured off twenty feet with a yard stick which was three inches short at one end. It is plain, therefore that three inches were lost on each yard in measuring eighteen feet, but none on the last two feet, as the yard stick was only short on the extreme end. The rope being worth two cents a foot, the dealer loses 81½ feet of rope, worth \$1.63, and \$3.40,

which he gave in good change, so he loses \$5.03, as the feature of getting the bill changed by a neighbor has nothing whatever to do with the question of profit or loss, many good mathematicians and puzzlists to the contrary opinion notwithstanding.

Tabby and Sport.

Of course, many mathematicians and puzzlists, in giving the answer to that exciting race between the cat and dog, say that, as Sport sprang five feet at each bound and the cat only three, but Tabby made five springs to Sport's three, they would be going at the same rate of speed, so the race should be a tie. It would be a tie if it were "a straightaway race," but in running to the stake and back seventy-five yards, each half of the race would be 112½ feet. The dog would be compelled to make twenty-three leaps to the stake and the same number in returning, which would be forty-six leaps of five feet each, so the dog goes 230 feet in all, which is a waste of five feet. The cat would go there and back in seventy-six leaps, which would call for 228 feet, so Tabby should win the race by two feet.

The Star Theatre Puzzle.

The interesting feature of this puzzle is that the people from the other side of the street would read the banners: "Tiny Democrats."

Answer to the Problem in Chances.

In that curious puzzle of George Washington Johnston and mixed-up hats, our bright mathematicians have demonstrated that the chances against any one of the six men receiving his own hat would be as 265 is to 455.

The comical dog story conceals the name of Calhoun.

The Adinco Puzzle.

The boy was right, here after AD would make it adhere. Here after in becomes IN HERE and here after CO would be COHERE.

AT THE RUINS hides the name: Corinth.

Macaulay's Last Riddle is the word "Manslaughter."

The description of the becalmed yachts conceals the name of Fairhaven.

Outwitting the Weighing Machine.

In that little problem of the five little girls who beat the weighing machine, it can readily be shown that there could be just ten different combination couples weighed, and that their separate weights must have been 56, 58, 60, 64 and 65 pounds to produce weights as given of 129, 125, 124, 123, 122, 121, 120, 118, 116 and 114. The two lightest together must weigh 114, and as we find by comparison of the weights of the third weight with the lightest and the second, that the lightest is two pounds lighter, we know that she weighs 156 and the next 158, after which it is easy to tell the rest.

The Price of Eggs.

In the cook's problem in domestic arithmetic it was said that she paid twelve cents for the lot, but made the grocer throw in two extra ones because they were so small, which made them cost just one cent per dozen less. Our clever puzzlist shows that the grocer offered her sixteen eggs for twelve cents, which would be at the rate of nine cents a dozen. She made him throw in two eggs extra, so that she got eighteen eggs for the twelve cents, which is at the rate of eight cents a dozen, or one cent a dozen less than the first price asked. Some pretty good mathematicians were puzzled over this little problem.

The Charade is Mated.

The young carpenters cut the table top as here shown, which is merely reversing the principle of the remnant puzzle so as to make it more difficult:

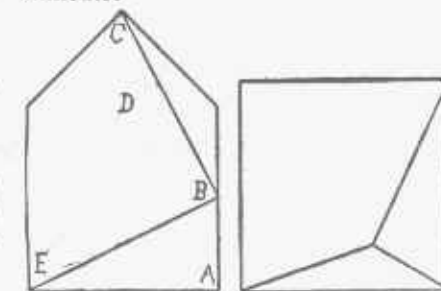

The description of those book-worms conceals the name Alaska.

FRESHMAN IMPRUDENCE is made to read: Orthodox Oxford dons don't know old port from log-wood, which is like the other: Per-severe ye perfect men, ever keep these precepts ten.

The missing word puzzles are: 1. entrance. 2. Desert, 3. Objects. 4. Object.

The necktie puzzle reads: "He might have gotten off with a fine but he got ten days as well."

Answer to Jimmy's Age.

If we call Paddy's age at the time he took to drink X, then Mrs. Murphy's age must have been 2-3 of X plus 2 2-3 years and Jimmy's age was 3 1-3 years. When the family total reaches 4 2-3 X minus 4 years it will equal 100 years, from which we get the value of X as 22 and 2-7 years.

Jimmy's present age is represented by 3 1-3 years plus 1-3 of X, so it is clear that he must be 10 and 16-21 years of age.

Answers to Concealed Geography, 133. Hague, 134. Houlton, 135. Amoy, 136. Erin, 137. Persia, 138. Erie, 139. Texas, 140. Stralsund, 141. Natick, 142. Olga, 143. Palos, 144. Verona, 145. Houghton, 146. Bogota, 147. Angier, 148. Hereford, 149. Erie, 150. Lima, 151. Hayti, 152. Acra and Peru, 153. Cork, 154. Nice, 155. Oneida, 156. Genoa, 157. Thebes, 158. Taunton, 159. Lima, 160. Saugus, 161. Alaska, 162. Nineveh.

In the puzzle of Tom the Piper's Son, who stole the pig. Mother Goose reports that Tom had to run 571 3-7 yards to catch the pig, while the porker ran three-quarters of that distance, which would be 428 4-7 yards. The simple rule for solving problems of this class is to halve the distance the man would have to travel to catch the pig in a straight line added to the distance he would go if they advanced toward each other. Tom is 250 yards from the pig, and as he goes one-third faster, in a straight line, he would catch him in 1,000 yards. If they run toward each other, Tom goes four-sevenths of the distance, viz.: 142 6-7 of the 250 yards, which, added to 1,000, equals 1,142 6-7 yards. Half of this equals 571 3-7 yards, which is the correct answer.

A Rebus=

Wedding bells were rung in the "Hebrides."

Aesop's Fable of the Wolf.

The best answer to the story of the hungry wolf who impersonated a policeman to accuse an innocent little goat which had been sleeping, of throwing snowballs at him, is well told in verse by a clever correspondent:
 "That cruel, wolfish copper
 Told the awful snowball whopper,
 To the little kid, on purpose to entrap her
 To confess a graver deed.
 And he quickly did succeed,
 For a sleeping kid is surely a kidnapper!"

Answer to the Strike Puzzle.

The foreman received \$1.10 for the first day and then 90 days at \$1.11, making 91 days for \$1.01. The handy man worked 101 days for \$101. The helper put in 1 day at 90 cents and then 110 days at 91 cents, making 111 days for \$101. In all 303 days work, for which the employer paid \$303.

In this curious demonstration of the truth of the old adage that "the longest way round may be the shortest way across" the problem was to "find the shortest way to string an electric wire so as to connect the two ends of a room 30 feet long. The wire was to be strung along the walls, ceiling or floor, from a push button three feet above the floor from the center of the room, near the door, as shown in the picture, to a point 9 feet high, or 3 feet from the ceiling, in the rear of the room, the room being 12 feet wide by 12 feet high and 30 deep.

The shortest distance will be found to be a winding course, along the two end walls, along one side and across one end of the floor, as shown in the accompanying illustration which requires 41,785 feet of wire.

The answer to that illustrated charade is because they are both fast.

Fido's Age Puzzle.

Let the sign X stand for Fido's age five years ago. Then sister's age (being four times older, or five times as old), would be represented by 5X. Adding five years to each, 5X+5 stands for sister and X+5 for Fido, and they are now in the ratio of three to one. That is, should we multiply Fido's age by three, resulting in 3X+15 it equals sister's age of 5X+5. A comparison of the two

forms shows that 2X equals 10 and X five years. To-day Fido is ten years of age and sister must own to thirty.

Bixley to Quixley.

After traveling forty minutes the guide stated that they had gone just half the remaining distance to Pixley, so it is clear that the time between Bixley and Pixley consumed 120 minutes. Later on between Pixley and Quixley he stated they were just half as far away from Quixley as from Pixley. Then they reached Quixley in an hour, which makes it clear that they consumed 180 minutes between Pixley and Quixley. Thus we have the time of the whole journey as five hours. It required 200 minutes for the seven-mile stretch, so the distance covered between Bixley and Quixley in 300 minutes must have been ten and a half miles.

In the Baseball problem the Sockers were victorious because if they had the 2 score, the Sluggers, according to usage, would not have continued after scoring 3 points.

In the Legal problem Grandfather first married Mary Ann who died and he married her sister and then departed this world himself, this evidently proves that he had married his widow's sister.

In that Criss-cross puzzle the word is "amaze."

That clever young carpenter divided the checkerboard into 18 pieces as here shown:



In the puzzle of Well Recommended the testimonial was like the War of Independence because it began by dropping the T into the C.

The Tower of Hanoi.

It would require 8191 transfers to solve this problem, according to rule it would be the 13 power of 2, less 1.

The Clothes Line Puzzle.

Since one piece of the clothes line was equal to five-sevenths of the other, the entire length of 100 feet divided by 1 5-7 will give the length of Mrs. Hogan's share as 58 1-3 feet and the balance, 41 2-3 feet, belonged to Mary O'Neill.

The Eccentric Will.

That remarkable puzzle of the Eccentric Will proved to be, as was intended, a remarkably difficult problem which baffled the most of our experts. It was told that Captain Smith left his money to nine heirs, consisting of a married son with a wife and child, a married daughter, her husband and child, and a stepson with a wife and child. Each husband was to receive a specific sum more than the wife, but the wife was to receive that same sum in excess of the child. The money consisted of one-dollar bills, put up in packages of sealed envelopes, each envelope containing just as many dollar bills as there were sealed envelopes in his or her package. It was stated that "Mary and Sarah together got just as much as Tom and Bill together, while Ned, Bill and Mary together got \$299 more than Hank, while the Jones family got over three times as much as the Browns." Only the Christian names of the heirs being given, the puzzle was to guess their surnames by the terms of the will, which solves as follows: Bill Jones got \$8,836; Mary, his wife, \$5,476, and the son, Ned, \$2,116. Hank Smith received \$16,129; his wife, Elizabeth, \$12,769, and their daughter, Susan, \$9,409. Jake Brown got \$6,724; his wife, Sarah, \$3,364, and their son, Tom, the black sheep of the flock, only \$4!

Answer to Billiard Puzzle.

In that problem of the billiard match, mathematics as well as practice shows that if Apfelbaum can beat Blumenstein when he gives him 20 points in 100, Apfelbaum makes 100 to Blumenstein's 79, for it is clear that if Blumenstein made 80 he would win, and A would not beat him at those odds. As Blumenstein gives Gugelheim 25 points, Blumen-

stein makes 100 to Gugelheim's 74. Therefore 74-100ths of 79, which is 58.46, shows what Gugelheim should make while Apfelbaum runs 100. While Apfelbaum runs 200 Gugelheim would make twice 58.46, which as there are no half points must be called 117. Apfelbaum could, therefore, give him the odds of 82 points, as 82 plus 117 equals 199, and would then just beat him by the required margin of 1 point. Mathematically speaking, Apfelbaum makes 1 and 2077-2923 to every 1 that Gugelheim scores.

In Pictorial Arithmetic Boat+Woman—Man leaves Boatwo, and this—Boa leaves TWO.

That puzzling query is because he is making a banquet.

That illustrated square word reads

P O S T
 O D O R
 S O D A
 T R A P

Answer to Family Puzzle.

Miss Pocahontas Smith must have been twenty-four and little Capt. John but three, with thirteen brothers and sisters ranging between. Once more some of our solvers failed to note that "seven times older" is the same as eight times as old.

The Postmaster's Puzzle.

She got five 2s, fifty 1s and eight 5s=\$1.

That rebus puzzle takes the first letter of shark, the C from ace, a from mean or base and to these add MP and it spells scamp.

In the Pictorial Charade we read Pot-he-carries weight.

The Mystery Puzzle.

This problem is readily solved by working backward, when it is revealed that I must have started with \$260, the baron had \$80 and the count \$140.

After the first round I had left \$40, the count and baron each doubling their piles and having then on hand \$280 and \$160 respectively. After the second round I had \$80, the baron \$320 and the count \$80. Then the count and I each doubled our money at the expense of the baron, and we were each left with \$160, and I was the only loser, to the extent of \$100.

The Juggler's Puzzle is solved as follows, by having one of the triangles:

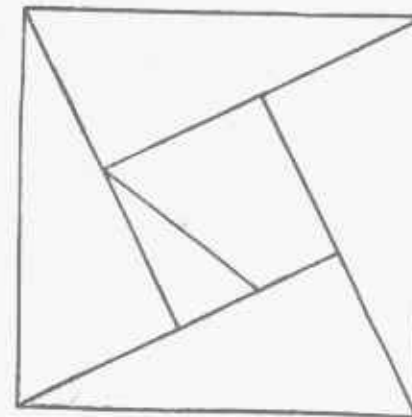

The Miller's Problem is explained by saying the customer has now nine parts of how much wheat? If he has nine-tenths of a bushel he must originally have had 10-9ths of a bushel; The miller took 1-9 and left him 9-9ths or one bushel.

Solomon's Temple Puzzle.

The carrying of the cube up an incline one mile long by half a mile in height would throw the centre of gravity of the block of marble back four and a half inches, so—mathematically speaking—the head man's hold of the arms is equivalent to 49 1/2 inches from centre. The positions of the other two men must be equal to half that distance each, so as to give them the best possible working positions we would place one man 14 3/4 inches back from the centre of gravity and the other 34 3/4 inches; then if each man lifts 210 2-3 pounds the weight will be evenly distributed. Of course, other distances besides 14 3/4 and 34 3/4 might be used to divide the 49 1/2 inches.

In that buried proverb we read: "A rolling stone gathers no moss."

A Rebus=Decanter.

A Rebus=Vivid.

Answer to Infantry Drill.

Describing this puzzle by the letters upon the hats of the little soldiers we will solve it by first moving B and C to the end of the line next to the drummer. Fill up the gap with E and F. Fill up the new gap with H and B, when by filling up the gap again with A and E, the feat is ac-

complished, but you will find it a very complicated trick to work it backwards again from this point, so as to bring them to the original position so that the boys and girls stand alternately in a row.

Mr. Funnyman's Joke is 69 cents.

Two Men and A Ditch Puzzle.

In that famous unanswerable problem wherein it is stated, that two men dug a ditch 100 yards long, wherein the first got 90 cents per running yard, and the other \$1.10 on account of the ditch being deeper, it can be shown that if the first man dug 55 5-9 yards at 90 cents, he would receive \$50. From the point C, the other man dug down to the road five feet deeper, and measured the hypotenuse line of 45 and 45-99ths, at \$1.10, which also makes \$50. Which is doubtless the intended answer to this problem, which has been a bugbear for several centuries.



The FALSE COLOR puzzle is explained by the following illustration:

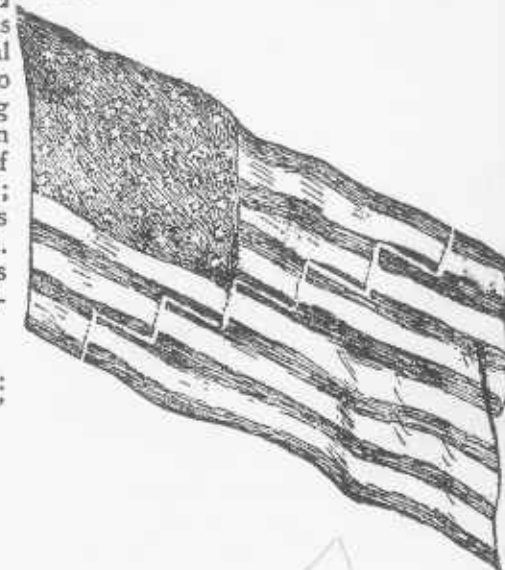

Rip Van Winkle's Game.

In the little bowling problem it was told that the pins were arranged in a row so that a player could knock down a single pin or any two adjacent ones. They play in turns, and as the little man of the mountains has knocked down pin No. 2, the

puzzle was to tell what is the best shot for Rip to make to win the game.

To retain the championship of Sleepy Hollow, Rip should now knock down pin No. 6, so as to divide the row into groups of 1,3 and 7. Then, no matter what play the little fellow makes, he will surely be beaten if Rip continues to make the best plays. To have won the game at the start, the little man of the mountains should have knocked out pin No. 7 so as to divide the row into two groups of 6. Then, whatever Rip knocked out of one group he would duplicate on the other, and thus win by a sure rule.

22 Birds.

- 1, Lark; 2, Eagles; 3, Black Cap; 4, Bird of Paradise; 5, Swallow; 6, Rook; 7, Kite; 8, Blackbird; 9, Sailor; 10, Crane; 11, Butcher; 12, Rail; 13, Mocking; 14, Rice; 15, Tailor; 16, Pedlar; 17, Secretary; 18, Turkey; 19, Armadillo; 20, Swift; 21, Jay; 22, Wren.

REBUS-PIGEON.

Alphabet Conundrums.

Of course there were different answers submitted to many of those conundrums built upon the letters of the alphabet, from which the following are selected as the best:

- A is like honeysuckle, because the B comes after it.
- B is placed before C, because we must be before we can see.
- C is like a schoolmarm, because she changes lasses into classes.
- D is like a squalling child, because it makes ma mad.
- E is like London, because it is the capital of England.
- F is like a fishhook, because it makes an eel feel.
- G is a hot day, because it is the middle of August.
- H is a cure for deafness, because it makes the ear hear.
- I is the lucky vowel, because it is in bliss while E is in hell and the others in purgatory.
- J is like your nose, because it is next to your eye.
- K is like a pig's tail, because it is the end of pork.
- L is like a queen, because it makes the knee kneel.
- M is a favorite with miners, because it makes ore more.
- N is like a pig, because it makes "a sty" "nasty."

- O is like a horse, because G makes it go.
- P is a false friend, because although the first in pity it is the last in help.
- Q is a guide, because it always goes head of U.
- R is a winner, because it leads in a race.
- S is a titled lady when it is a dutch S.
- T is like an island, because it stands in the middle of water.
- U is not so queer as I, because I was the queerist.
- V is the spooney letter, because it is always in love.
- W is like a scandal, because it makes ill will.
- X is a mystery, because it is inexplicable.
- Y is a great lady, because it is the Fourth of July.
- Z is like monkey cage, because it is the leading feature of the Zoo.

Alphabetical addition is solved by the key-word Peach Blows, a famous brand of potatoes. Number each of the letters consecutively.

Second Alphabetical Addition is Don't be lazy.

Evolution Puzzle—Fade, made, male, mile, milk, silk.
A CHARADE is Parrot.

In our trip through the dictionary we found the words: Scion, Suspicion, coercion, internecion and epinicion.

Answer to the Goose Puzzle.

The accompanying figure shows how to divide the goose into three pieces which will fit into the egg.



STREET PUZZLES.

There is one class of puzzle which may be referred to as novelities or curios, which are peddled on the sidewalks by the street hawkers and about which I desire to give a few words of advice or caution. Hardly a day passes without my receiving a communication about some game, puzzle or novelty which the author desires to put upon the market. I always remind them of Puck's advice to young couples contemplating matrimony: "don't!"

In the first place street sales are very disappointing. It is great cry and little wool. Such sales scarcely amount to anything at all and actually kill the orders from the big stores. My advice is never patent, copyright or manufacture any article of this kind until a positive order has been secured which will cover all expenses.

Not more than one puzzle or game out of a hundred is a success. You run no risk in showing your idea before a patent has been secured; I have been handling inventions for half a century and never heard of an idea being stolen.

Here is a specimen of a street-hawker's proposition:



The picture represents two empty cages, but there is another piece of movable cardboard which slides in grooves behind the picture. The spaces between the bars are cut out and two rats are drawn (in sections) which can be concealed by the bars). By moving the card board from right to left only one rat can be seen at a time, so it gives the appearance of jumping from one cage to another.

THIS FAMOUS 14-15 PUZZLE.

Starting from original position Fig. 2 may be reached in 44 plays as follows: 14, 11, 12, 8, 7, 6, 10, 12, 8, 7, 4, 3, 6, 4, 7, 14, 11, 15, 13, 9, 12, 8, 4, 10, 8, 4, 14, 11, 15, 13, 9, 12, 4, 8, 5, 4, 8, 9, 13, 14, 10, 6, 2 and 1.

Fig. 3 may be reached in 39 plays: 14, 15, 10, 6, 7, 11, 15, 10, 13, 9, 5, 1, 2, 3, 4, 8, 12, 15, 10, 13, 9, 5, 1, 2, 3, 4, 8, 12, 15, 14, 13, 9, 5, 1, 2, 3, 4, 8 and 12. To produce a magic square adding 30 the following is the best: 12, 8, 4, 3, 2, 6, 10, 9, 13, 15, 14, 12, 8, 4, 7, 10, 9, 14, 12, 8, 4, 7, 10, 9, 6, 2, 3, 10, 9, 6, 5, 1, 2, 3, 6, 5, 3, 2, 1, 13, 14, 3, 2, 1, 13, 14, 3, 12, 15 and 3.

The real trick of the puzzle could only be performed by changing the 9 into a 6 and the 6 into a 9, by turning them upside down during the manipulation of the blocks.

ANSWER TO PICNIC PUZZLE.

There must have been 900 picnickers who would be seated 9 to a wagon if there were 100 vehicles, or 10 to a wagon after 10 of the wagons had broken down. When they started for home with 75 wagons, it was necessary for 12 persons to ride in each wagon.

Miss Tokio first steps to the first rung then back to the ground; then to 1 and 2, back to 1, up to 2 and 3, etc., always one step down and two up, and the feat can be performed in 23 steps. Hiki's watermelon may be arranged as follows:

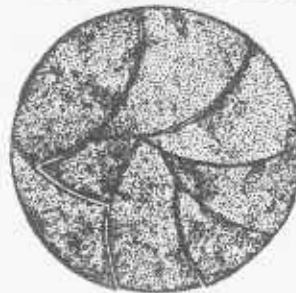

The first charade is Godlike; the second Massacre; the third Pocket-book.

TELEGRAPH POLE PUZZLE.

The bewildering feature of the telegraph pole problem turns upon the fact that no matter how many poles you may assume to pass in one minute, the speed of the train varies, but the distance between

poles is the same, because we multiply and divide by the same number. Let x represent the number of poles passed and multiply by 3 5-8 times 5,280 (number of feet to a mile), and divide by x times 60, and the answer will always be 319 feet between poles. But as there would only be 59 spaces between 60 poles, we should divide the 19,140 feet by 59 to get 324.24-59 feet, as the correct answer.

The Bungalowose crap player must have thrown a 1 which added to 4 gives him 5, leaving 10 to the other player who wins by 5 points. 109,778 represented in the sextimal notation would be 2204122. The figure to the right represents units; then two 6s, then one 36, four 216s; no 1296s; two 7776 and two 46656s which, added together, proves the sum. The numbers increase by the multiples of 6 instead of 10, as in the decimal notation.

The first charade is Sunshine, the next Blockhead.

SOLUTION TO DROVER'S PUZZLE.

Hank had eleven animals, Jim seven and Duke twenty-one, so that there were thirty-nine animals altogether.

PUZZLELAND ALGEBRA is:
96327
85014

181341.

The Darktown students patched the checkerboard as follows:

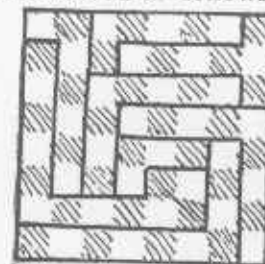

The first charade is Windlass, the next Margin, then Offence.

JACK AND JILL PUZZLE.

In the Jack and Jill problem, it being clear that 60 feet down hill is equal to 40 feet up hill, we see that Jack accomplished the equivalent of 1,360 feet and Jill but 1,260 when they met, which shows their speeds to be in the proportion of 63 to 68. As Jack beats Jill by 5-63

of his time, which was equal to half a minute, 1-63 of his time is equal to 6 seconds, and his whole time, therefore, would be 6 minutes and 18 seconds, which is the correct answer to the problem of Jack's speed for the half-mile run.

WORTH THEIR WEIGHT IN GOLD.

In the problem of the dowers of the June brides we were told that the three brides weighed 396 pounds, and that there was a difference of 10 pounds between each. Kitty therefore weighed 122, Nellie 132 and Minnie 142 pounds. As Brown weighed the same as his bride, we will pair Kitty and Brown, weighing 244. We pair Nellie and Jones (198) at 330, and Minnie with Robinson (284) to make the required 426, which gives a total of 1,000 pounds, or half a ton.

THE GAME OF MATRIMONY wins by the play of one, two or three. Then the winning points are 9, 15, 22 and 28. You will also win if you count 34 on the thumb, 32 on the 2, 31 on the 3, 30 on the 4, 24 on the 3, 19 on the 2, 17 on the 4, 16 on the 2, 11 on the 3 or 6 on the 2.

In that clever riddle either screw is insecure.

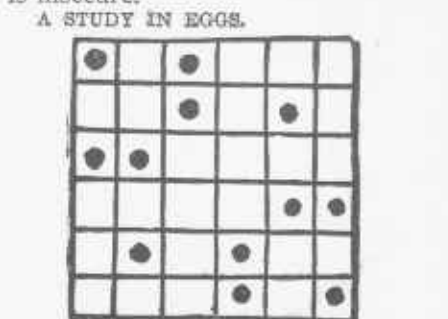

Good Advice says: "In order to be wise beak on tent tool urn."
PUZZLE.

Had Mrs. O'Flaherty invested but 42 cents she might have purchased one pound of turkey and one pound of goose. Now, if she spent that same amount of money equally divided between geese and turkeys she would have received 21-24s of a pound of turkey and 1 2-18s pounds goose—2 1-24s pounds altogether, which is a gain of 1-24 of a pound, resulting from her laying out her 42 cents by the new method.

Since an investment of 42 cents will produce a difference of 1-24th of a pound between the two methods of purchasing, it is clear that she must invest 48 times 42 cents, or \$20.16, to gain 2 pounds by the Christmas method.

Investing \$10.08 in turkeys and the same amount in geese she received 42 pounds of one and 56 pounds of the other, whereas had she bought equal quantities of each she would have received but 96 pounds altogether.

THE ARCHITECT cut on a straight line from the second place, as indicated by the King's thumb, to the third space as pointed out by a finger at the top, then move the right hand piece up one space and you will find that there are but 124 cells, which enables you to lay out a route starting from and returning to the left hand corner, passing through all the cells but once.

THE ILLUSTRATED TOWNS are she really lost 32 cents by the exchange.

MERRY-GO-ROUND PUZZLE.

There must have been thirteen children on that Merry-go-round. Those who rode ahead of Willie at the same time came behind him. As there were twelve of them, we simply add three-quarters of twelve to one-third of twelve, which gives thirteen, the total number including Willie himself.

HEIDELBERG PUZZLE.

A rule for solving this problem is to divide the total number of students into the difference between the amounts produced by multiplying the separate student groups by the total group—the quotient being the number by which one group exceeds the other.

We must find a number less than 24 which will divide evenly into 108, and 18 fills the bill. The quotient 6 is the excess of Red Caps over Blue Caps. Therefore there must have been 12 Red Caps and 6 Blue Caps. The Red Caps consumed 216 steins and the Blue Caps

The Frenchman wished to say that he found a hair in the butter. THE OLD WOMAN in the shoe had 55 children as proven by the

occupations and sports of those shown in the picture.

THE LETTER CARRIER commenced at Ave. B and 1st street, went up 1st street to Ave. C, which he followed to 3rd street, down to Ave. A, thence backward to 2d street, up to Ave. C, along to 4th street, down to Ave. A, back to 1st street, up to Ave B, and through to 4th street.

THE DICE GAME: Player should commence with 2 or 4 if he hopes to win.

THE ARCHERY Puzzle answer is 17, 17, 17, 17, 16, 16 = 100.

THE RECESS HOUR Puzzle may be read: "One ought to wait for tea."

MATHEMATICAL COP PUZZLE.

The mathematical cop says that his conversation with McGuire occurred at 9:36 A. M., because one-quarter of the time from midnight would be 2 hours and 24 minutes, which, added to half the time till midnight (7 hours and 12 minutes), equals 9:36.

Were it not for the fact that McGuire bid Clancy good morning, showing that their conversation took place in the A. M., it might be assumed that the time was P. M., and 7.12 P. M. would be an equally correct answer.

THREE 12-INCH NAPKINS will cover a 15 and 1-4 inch square table. Place one squarely on one corner and the others will easily cover the remainder.

These are the Twenty-one Palindromes that the rhymes concealed: 1. Anna. 2. Eve. 3. Ada. 4. Nun. 5. Madam. 6. Bib. 7. Pap. 8. Gig. 9. Level. 10. Ewe. 11. Noon. 12. Eve. 13. Pop. 14. Pup. 15. Pip. 16. Mum. 17. Gog. 18. Eye. 19. Tenet. 20. Peep. 21. Deed.

THE HARDWARE STORE sells: Hammers, glass, spades, bolts, locks, buckets, tacks, pails, casters, stove lifters, saws, pulleys, monkey-wrenches, white leads, quays and springs.

THAT FRENCH CRYPTOGRAM reads: "J'ai grande appetite" a little too long too wait for tea. The P. S., is supposed to mean "add a line more" viz.: Adaline Moore. THE FOUR SOUNDS are ring, roar, bark and creek.

BUSINESS PUZZLE.

As the difference between a price which is 10 per cent. advance upon one doll and one which is 20 per cent. advance upon ninety cents is two cents, which is 1.55 of the former price, so in this case the price for which the goods sold is fifty-five times twenty-five cents, which is \$13.75.

A little study will give the several names of Bluebeard's wives correctly, and the keys may be placed in the following groups: 78x 345 = 26910.

SUBSTITUTE an E for R and spell FEALTY.

IN PUZZLELAND you can see the portrait of Washington by glancing from left to right along the center of the big tree. The simplest way to cut a square into six squares is to mark it off into nine squares, then the largest one will be made up of four squares, and there will be five more little ones:

THE CHARADES are: Hardship, Shakespear and Bugbear.

CREDIT CHECK PUZZLE.

In that mark down china sale Mrs. Bargainhunter bought ten plates at 13 cents each on Saturday and returned them on Monday for eighteen saucers at 3 cents each and eight cups at 12 cents each, making a total of \$1.50, as she returned the plates at 15 cents each; but on Saturday she could have bought thirteen cups at 10 cents each, so

LITTLE BO PREP arranged the four pieces as follows:



THE CHARADES read: Vanguard, strategem and Sapling. MILITARY PUZZLE: Align.

THE PUZZLELAND Swiss Flag

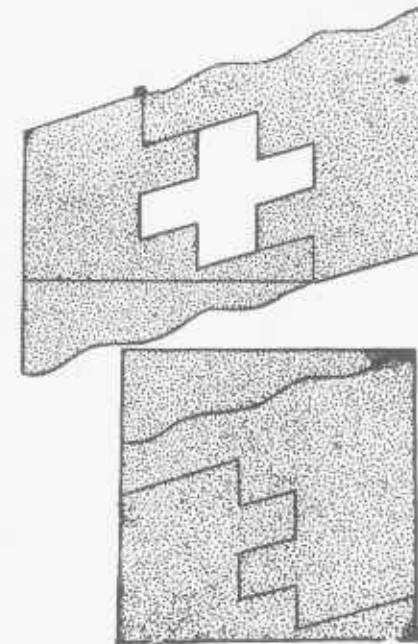

Puzzle is solved as follows: A Swiss Cheese can be divided in to 26 pieces by five straight cuts. A chessboard may be divided into 18 pieces without any two pieces being exactly alike, as follows:

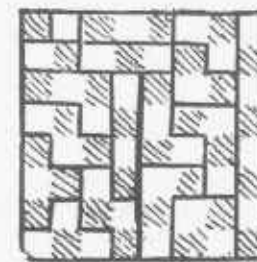

SOLUTION TO ABACUS PUZZLE.

In the Abacus problem, the Canton merchant must have purchased 44 puppy dogs for 88 bits, and 22 pairs of rats at 2 bits a pair, making in all 132 bits. He sold 39 dogs at 2.2, equals 85.8, and 21 pairs of rats at 2.2, thereby getting back his original outlay of 132 bits. He then had 5 dogs to retail for 11 bits, and one pair of rats for 2.2, which would be 13.2, or 10 per cent. upon his first investment.

THE PHILIPPINE TRADERS have four rings weighing a quarter of a pound, three-quarters of a pound, two pounds and a quarter and six pounds and three-quarters. By clever juggling with these four

weights, so as to place some on opposite ends of the scales as counter balances, any odd number, like three and a half pounds, may be weighed.

THE BURIED CITY puzzle is Dublin.

OUR COLUMBUS PROBLEM.

80.55 decimally expressed = 80.5
99
—
97 " " = .97
—
99
46 " " = .46
—
99

82. Total. Therefore = 82.

The . over a number signifies that it is a repeater which would go on for ever, as when we endeavor to describe 1-3 decimally, viz.: 3)10.(3333 etc., ad infin., but

expressed .3; with a series of numbers we place the dot over the first and last, as with 1-7, viz.: 7)10(1.42857, which series of numbers would repeat in the same sequence for ever. The remarkable feature being that a repeater is exactly

equal to 1-9, viz.: 1-9 and .1 are the same.—5-9 = .5, just as the

series .142857 = 142857 over 999999.

CHARADES: Nameless, Butchery.

PUZZLING PRATTLE.

In that puzzling prattle it is evident that the children were so befogged over the calendar that they had started to school with their books on Sunday morning! for it is plain that when the day after tomorrow is yesterday, to-day will be three days hence, just as when the day before yesterday was tomorrow carries us back three days from now, which must be Sunday, to be midway between the two "to-days."

HIDDEN CITIES and RIVERS: Pesthe, Augusta, Lima, Carson, Cleburn, Atchison, Po, Nile, Seine, and Don.

HORSE TRADE PUZZLE.

Sixty dollars is half the cost of the animal and three-quarters of the cost of his keep. This makes one quarter of the keep one-third of \$47 and the total loss \$28 2-3.

ANSWER TO BATTLE OF FOUR OAKS.

The accompanying cut shows how to divide the square lot into four pieces of the same shape and size, with a tree to each piece.

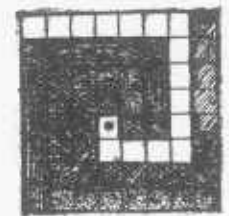

REBUSES: Pideon and Aspire. A SWITCH BOARD Problem may be wired so as to require but 234 inches, as follows:

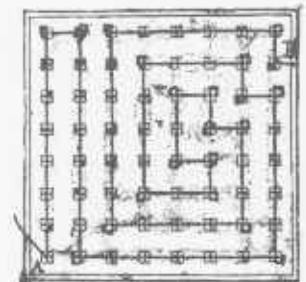

THE HISTORICAL BURIED CITY is Edinburg, followed by 195 Weser, Elbe, Thames, Ganges, Tagus, Canada, Kissingen, Hingham, Angora, Dalton, Ireland, Bethel, Rye, Stafford, Acre, Susa, Gravesend, Coromandel, Persepolis and Cordova.

ANSWER TO EGG PUZZLE.

Regarding the question as to how high Hans could safely build a pyramid of eggs if each egg weighs two ounces and would sustain a pressure of eight pounds, it may be said that the industrious grocer has found by actual trial that a triangular pyramid of 193 eggs on the line of the base would contain 18,721 eggs, which would support the 192 layers containing 1,216,865 eggs. It makes no difference whether we build a square

or triangular pyramid, the number of layers will be the same.

To find the number of eggs in a square pyramid multiply the number of eggs on one side of the base by that same number plus one, multiplied by twice the number plus one, and divide by 6. Mathematically expressed in would be $n(n+1)(2n+1)$ divided by 6. To calculate the number of eggs in a triangular pyramid it would be $n(n+1)(n+2)$ divided by 6.

THE RED SPADE may be changed into a heart by cutting into three pieces as shown, and insert the triangular piece below.

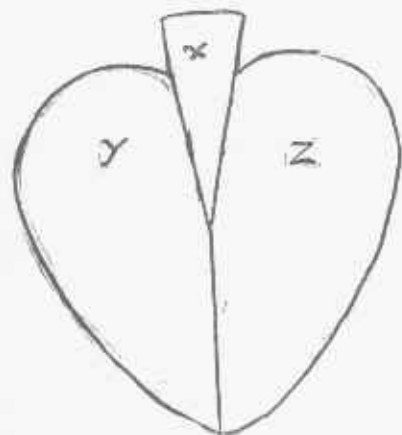

PLAYING THE SYSTEMS.

The conditions were according to Lord Rosslyn's system of playing seven times each upon the multiples of 7.

There are one or two ways of varying the answer, but the principle involved is always the same in producing the required result.

He loses seven single francs in succession, then loses three 7-franc bets and wins four 7-franc ventures, which makes his losses and gains equal.

He then wins twice on 49 and loses five times on the same number, and then wins seven times on 343.

He now loses three times on 2,401 and wins four times, then wins twice on 16,807 and loses five times, and finally wins seven times on the limit of 117,649, so that in all he has won 869,288 francs and lost 91,511, which leaves him just 777,777 francs ahead of the game.

IN ANCIENT GREECE they draw

the symbol in 14 strokes as follows:

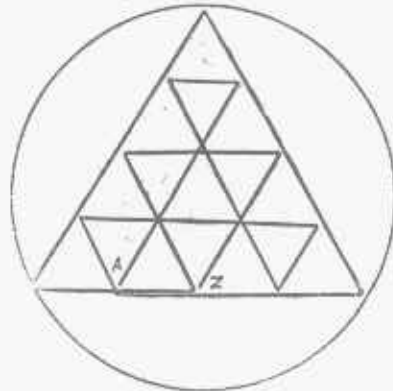

THE BURIED CITY is Coblentz.

THE CRIMINAL CLASS buried city puzzle conceals the name Armenia.

THE BOY'S AGE PUZZLE.

The first girl was just 638 days old, and the boy twice as much, namely 1,276 days. The next day the youngest girl will be 639 days old, and her new recruit 1,915 days, total, 2,554 days, which doubles that of the first boy, who having gained one day, will be 1,277 days old. The next day the boy, being 1,278 days old, brings his big brother, who is 3,834 days old, so their combined ages amount to 5,112 days, which is just twice the ages of the girls, who will now be 640 and 1,916, or 2,556.

The next day, the girls gaining one day each, will represent 2,558 days, which added to 7,670 days of the last recruit, brings up their sum total to 10,228 days, which is just twice that of the two boys, which, with the two points added for the last day, would be increased to 5,114 days.

We arrive at the 7,670 days by saying, the young lady having reached her twenty-first birthday, 21 times 365 equals 7,665 plus 4 days for four leap years, and the extra one day, which comes with the twenty-first birthday (which is one day towards the twenty-second year, involving the twentieth century muddle).

In answer to the query how old was that youngest boy, the reply should be 1,276 days.

Those who gave the boy's age as 3 1-2 years entirely overlooked the feature of increasing the ages of the pupils from day to day.

SOLUTION TO RENT PUZZLE.

As a difference of 25 cents per bushel in the price of wheat makes a difference of a dollar an acre in the rent, the rent paid in wheat is four bushels per acre. Deducting the value of four bushels of wheat from the total rent leaves \$4 an acre as the rent paid in cash, and dividing \$80 by four gives the number of acres as twenty.

TRADE SECRET Puzzle should be read "He's easy."

THE MONASTERY TREASURY.

We practically absorb the leap year feature by saying that a year is 52 weeks, 1 day and 6 hours long, which is the same as 52 5-28 weeks long. Now, as it takes just 28 years to make that 5-28 run into even years, we will say $28 \times 52 \frac{5}{28} = 1461$ weeks as a perfect circle of years ending with a Saturday. But as we must have a number of coins which can be divided by four or five or six we find that we must have a number of weeks divisible by 60, so we get such a number by multiplying 1461 by 20, which will give 29,220 as a series of weeks divisible by 4, 5 or 6 to suit the piles of coins, and divisible by 52 5-28 weeks, which converts it into 500 years, as representing the correct age of the monastery when the coins were counted.

THE REBUS and CHARADE are Scamp and Decanter.

THE LONDON FOG teaches the moral that it is "vain to aspire."

INVERNESS TO GLASGOW.

Regarding the trip from Inverness to Glasgow, a distance of 189 miles, the difference between the two speeds being one mile per hour, we get x plus a half mile per hour for speed of the stage, and x minus one-half mile per hour for that of the train, which gives the equation 189 over $x - \text{one-half} = 189$ over $x + \text{one-half}$ equals 12. Whence 192 equals $12x^2$, and x equals 4. The speeds, therefore, are 4 1-2 miles and 3 1-2, which shows that the place of meeting was seven-sixteenths of 189, or 52 11-16 miles.

A REBUS.

ANSWER TO MISER PUZZLE.

In this problem it was told that a miser had a hoard of \$5, \$10 and \$20 gold pieces which he could divide into four, five and six parts, each containing similar coins. To do this it has been shown that he must have had not less than 60 coins of each denomination, which would make a total of \$2,100.

THE FOUR ELOPEMENTS.

Contrary to the published answers to the famous puzzle of the four couples who had to cross a river in a boat which would carry but two persons at a time, the feat can be performed in 17 trips, instead of 24. Utilizing the island in the middle of the stream and complying with the conditions that no young lady was to be in the company of any gentleman unless her fiance was present, and no man was to be alone in a boat, if any young lady was left alone, except the one to whom she was engaged.

Describing the young men as A B C D, and the young ladies as a b c d, the 17 trips of the boat can readily be followed.

Shore	Island.	Over.
A B C D a b c d	o	o
A B C D c d	o	a b
A B C D b c d	o	a
A B C D d	b c	a
A B C D c d	b	a

Now the men begin to do some rowing.

C D c d	b	A B a
B C D c d	b	A a
B C D	b c d	A a
B C D d	b c	A a
D d	b c	A B C a
D d	a b c	A B C
D d	b	A B C a c
B D d	b	A C a c
d	b	A B C D a c
d	b c	A B C D a
d	o	A B C D a b c
c d	o	A B C D a b
o	o	A B C D a b c d

ANSWER TO THE LAKE PUZZLE.

In this remarkable problem we find that the lake contained exactly eleven acres, therefore the approximate answer of "nearly eleven acres" is not sufficiently correct. This definite answer is worked out

by the Pythagorean law, which proves that in any right-angle triangle the square of the longest side is equal to the sum of the squares of the other two sides.

In the illustration A B D represents our triangle, A D being 9 acres long and B D 17, because 9×9 equals 81, which added to 17×17 (289) equals the 370 acres of the largest field. A E C is a right-angle triangle, and the square of 5 (25) added to the square of 7 (49) shows that the square on A C equals 74. C B F is a right-angle triangle, which shows that the square of its sides 4 and 10 prove the square estate on B C to equal 11 acres. The area of our triangle A D B is clearly the half of 9×17 , which equals 76.5 acres, and as the areas of the oblong and two triangles can plainly be seen to be 65.5, we deduct the same from 76.5 to prove that the lake contains exactly 11 acres.

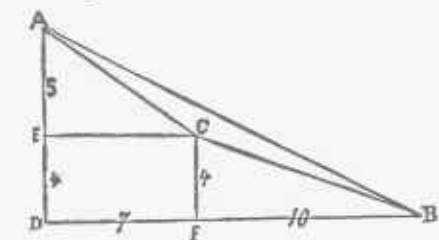

ANSWER TO BEATING THE RECORD.

In that trotting match puzzle it can be shown that the four quarters were trotted respectively in 27 1-4, 27, 27 1-8 and 27 1-8, made in the record time of 1 min-ute and 48 1-2 seconds.

ANSWER TO THE HAM PUZZLE.

Many puzzlists and good mathematicians will be surprised to learn that he started off with fifty-five hams. Let us prove the answer and find out how much he received for them.

The first person he met purchased half his stock and half a ham, which disposed of twenty-eight hams for \$35. His next customer took half of his stock and half a ham (fourteen hams), and directed him to another place, where he disposed of half of what remained and half a ham, which

would be seven more, which leaves him with six hams and \$61.25 cash on hand.

The landlady then buys half of his stock and half a ham, which would be three and a half hams, for which she must pay \$5, as the half a ham cost as much as a whole ham.

He then met the hotel man, who, out of the remainder of two and a half hams, "took half a ham and the half of what remained, which would be a ham and a half, for \$2.50, leaving just one ham, which was purchased by the friend, who took half of what was left and half a ham, for \$1.25, which cleaned out his stock and left him with \$70 in cash."

PUZZLING PARTNERSHIPS.

It would seem at the first blush as if any number of fish from 33 to 43 might have been caught, as one may try experimentally by giving A from O to 11 fish and the quantities to be received by the others become apparent. There being five partners, however, who are to receive equal amounts in the final division, it is clear that the number must be 35 or 40. Take the latter number and it readily solves and shows that A had 8, B 6, C 14, D 4 and E 8. Now if B, C and D pool their issues, making 24, each gets 8, after which no matter how many join and then divide their stocks, the shares remain 8, but if any number is experimented with, even if the fish could be chopped up, it resolves itself into an odd complication.

WEARY WILLIE PUZZLE.

Willie had traveled 72 miles and Dusty only 54 when they first met, so the distance from Joytown to Pleasantville was 126 miles.

ANSWER TO EASTER MORN.

In this pretty puzzle, which, as may be seen, is closely allied to the Red Cross problem, there are to be four pieces, which will fit together and form the symmetrical Greek cross. The following figures show the manner of cutting and placing the pieces together:

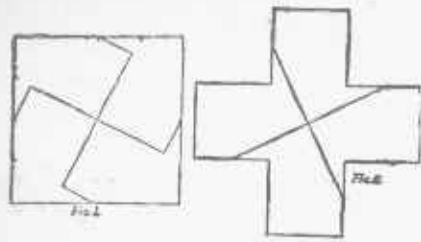

ANSWER TO THE MESSENGER BOYS PUZZLE.

It will be found that Harry started with 30 cents and Jimmy 48, and at one time had doubled his pile to 60, which left Jimmy with 18, who then plunged and had 36. It behooved Harry, therefore, to return Jimmy just 12 cents.

ANSWER TO CHINESE PUZZLE.

The following diagrams show the manner of cutting the prisoner's board into two pieces which can be fitted together so as to form a perfect square. The ingenious trick which was referred to as making it difficult to locate the exact position of the openings turns upon the odd niches which were hidden by his head.

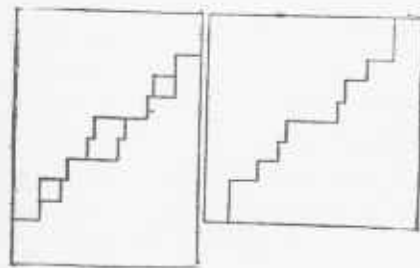

UNCLE SAM'S FOB-CHAIN PUZZLE.

Mathematicians and puzzlists who revel in the mysteries of permutations and possible combinations, have computed that no less than 92,160 different fob chains could be made from four coins and the pendant eagle, so that no two could be exactly alike.

It is evident that the large coin could be suspended from any one of the five holes, and with either side toward you, which would make ten possible changes. As the five-

cent piece can be placed in eight positions, these two alone would represent eighty combinations, which, multiplied by the six positions of the cent piece, and again by the four changes of the dime, and by two positions of the eagle, would show that in the order of size in which they are now strung there could be 3,840 changes made, as there are twenty-four different strings of coins to be made, by merely changing the order of the coins according to their size, 3,840 x 24 gives 92,160 as the correct answer to the puzzle.

BANANA PUZZLE.

The amount of money was 336 shillings. This would buy 48 bunches each of red and yellow, 96 in all, but 168 shillings would buy 56 bunches of yellow and the other 168 would buy 42 bunches of red, 98 in all. The difference between three-sevenths and one-half which is one-fourteenth is an amount which would buy two more at three shillings than it would at four, which amount is twenty-four shillings.

Therefore, if one-fourteenth of the money is 24 shillings, the whole amount must be 336 shillings.

THE INQUISITIVE CHILD Said because it is past your age.

Referring to the problem of Martha's Vineyard, wherein it was required to tell how many grape vines, not closer than nine feet apart, can be set out in a square plot just one-sixteenth of an acre in size, it may be assumed that all hands found that the plot would not be large enough to get more than 36 vines in the regular rows. By drawing a line on the bias, from one corner to another, and crossing and paralleling the same, it will be found that 41 vines can be planted, a little over nine feet apart, and well within the fence line, while on the other hand, to plant the first row of six vines on the base line, and a second row 7.77 feet above with but five vines, and the next with six, etc., arranged upon the pattern of an equilateral triangle, we could plant but thirty-nine vines.

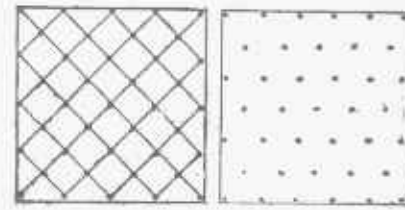

COUNTING CHICKENS.

People who count their chickens before they are hatched are so reckless with figures that it was to be expected that out of the many answers received to that poultry problem very few of them would have seen the young couple through their wedding expenses, to say nothing about the \$3,000 mortgage which had to be met on the third year. To show, however, that their calculations were all right, we will explain that Claude started off with twelve chickens, of which ten were hens, so that with the spring came ten broods of a dozen little chicks, half of which being hens, he would have now altogether seventy hens and sixty-two gentleman chickens. He would sell off forty-eight broilers, so as to always keep the same ratio of the sexes. The second spring he would have seventy broods of a dozen each, which would add 420 hens to his poultry yard and give him 336 broilers to sell for household expenses. He would then have 490 hens and 98 roosters, so with the next hatching of 5,880 plus 490 hens and 98 roosters he would have the required 6,468 wherewith to pay off the mortgage.

It will be seen that twelve eggs represents the number furnished by each hen, and that at each hatching the number of male and female little chicks are equal, and enough of the young roosters are sold to maintain the ratio of 10 to 2.

IN THAT YACHT RACE it will be found that the first leg of the triangle was sailed in 80 minutes, the second in 90 and the last in 160, making in all five and a half

hours; so if the boats started at 9 minutes past 10, the race finished at 3:40.

SOLUTION TO DIRECTOR'S PUZZLE.

The difference in interest at 6 per cent. and 7 1-2 per cent. on \$4,000,000 is \$60,000, which is equal to 1 per cent. on the common stock. Therefore there must have been \$6,000,000 worth of common stock.

DROP LETTER PUZZLE. "To be wroth with one we love, doth work like madness in the brain."

THE EXPRESS PUZZLE.

The answer to this paradoxical problem is the shortest reply to the many correspondents who claim that it is impossible of solution.

It was told that the belle of the Mining Camp had received two square boxes by express. One of the boxes is visible and the other is concealed in the wagon; but we are told that they are both perfectly square and that one is just twice as high as the other. It was further explained that the expressman wished to collect according to the cubical contents of the boxes, but that the miners objected and proposed paying according to the length of the boxes per running foot.

The expressman had demanded the rate of \$5 per cubic foot, and when he compromised and accepted \$5 per running foot it was discovered that there was not the thousandth part of a cent difference in the two ways of charging. Hence the question of the puzzle: What were the sizes of the two boxes?

The larger box must be 13,856 inches square and the smaller one is 6,928 inches wide. The two together would measure 20,784 inches, which at \$5 per running foot would amount to \$8.66. We then ascertain that the two boxes would contain 2,992 cubic inches, which

equal 1.732 cubic feet, which, at the rate of \$5 per cubic foot, would also amount to \$8.66.

In that interesting problem of the reapers who cut a swath round and round a square field until half the crop was gathered, I find that they had a simple rule which can be applied practically without any knowledge of mathematics. They said that "one-quarter the difference between a short cut cross lots, and round by the road, gave the width of the strip round the lot which took half the field." All of which requires a little explanation to make clear to mathematicians, who will understand it better when we say: from the sum of the two sides subtract the diagonal and divide the remainder by 4.

The field was 2,000 yards long by 1,000 wide, so by the aid of a tape line the farmers found that diagonal line, cross lots, from one corner to another, was a little over 2,236 yards, while to go "round" by the road, of course, was 3,000 yards, so the difference would be a little less than 764 yards. One-quarter of which would be just a little shy of 191 yards. So the honest farmers staked off a swath all round the field that width (190.-9831) and found that it gave to each an equal share of the crop.

ENDLESS CHAIN PUZZLE.

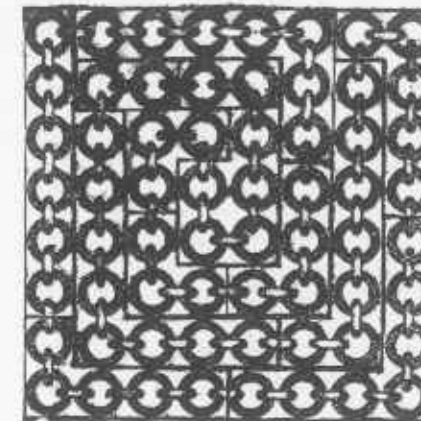

CONCEALED GEOGRAPHY: Venice, Corinth, Malta, Newark, Salamanca, Balisee, Palmyra, Serinogapatani, Bethsaida, Missolonghi, China, Rome, Athens, Hanover, Stow, Verona, Geneva, Gosham, Athol, Normandy, Chester, Colorado, Ebro, Rhine and Rhone.

SOLUTION TO MARBLE PUZZLE.

The number of marbles which Harry had left is one-fifth of the whole number or two-fifths of his original number. The original number increased by twenty is six-fifths and twenty is one-fifth of the original number. Therefore, each of the boys must have started with just one hundred marbles.

THE BATTLE OF HASTINGS PUZZLE.

There seems to be such a unanimity of opinion among our historian puzzlists regarding the number of men in the eventful battle of Hastings, which occurred Oct. 14, 1066, that I am inclined to accept their account of the deployment of troops as being correct. They estimate that Harold had thirteen squares of 180 men on each side, which would give 180x180x13=421,200 men. This number, with Harold added, would form one great square with 649 men on the sides. Just how many men William of Normandy must have had in his army, to rout them as he did, might readily be shown in the same way.

It may be of interest to mention that a square number is a number produced by the multiplication of any number into itself: Thus 4 multiplied by 4 is equal to 16, and 16 is consequently a square number, 4 being the square root from which it springs. The extraction of the square root of any number takes some time, and after all your labor you may perhaps find that the number is not a square number. To save this trouble, it is worth knowing that every square number ends either with 1, 4, 5, 6 or 9, or with two ciphers, preceded by one of these numbers.

Another property of a square number well worth mentioning is that if it be divided by 4, the re-

mainder, if any, will be 1. Thus, the square of 5 is 25, and divided by 4 leaves a remainder of 1; and, again, 16 being a square number, can be divided by 4 without having a remainder. It must be understood, however, that whereas square numbers show that peculiarity, other numbers, like 20 or 21, etc., are not square numbers, although divisible by 4, etc.

SOLUTION TO CHICKEN PUZZLE.

Josiah and Mariah must have had 300 chickens, with feed enough to last sixty days.

Multiplying 300 by 60 gives the number of individual daily chicken meals as 18,000. Should Mariah's suggestion be followed, and 75 chickens sold off, then 225 divided into 18,000 shows that the feed would last 80 days, whereas if Josiah purchased a hundred extra fowl, 400 divided into 18,000 gives 45 as the number of days the stock would last.

PUZZLELAND MOTHER GOOSE.
Twice 4 equals 8, and 20 equals 28, so if one-seventh, the four dead ones, remained, the rest flew away.
CHARADES. Sunlight, Looking Glass, PUZZLELAND cutting puzzles.

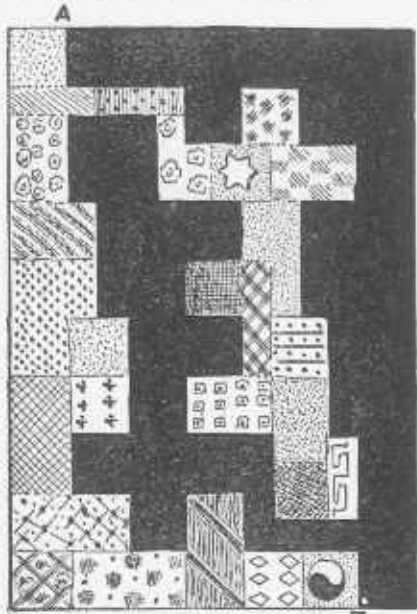

Cut on line from A to Z. THAT LOBSTER PROBLEM.

Lobsters are first sold for eight shillings a dozen, which would be the same as forty-eight shillings for six dozen, or thirty-two shillings for four dozen, as stated. Therefore, whether we are talking English or United States money,

the cost of a single lobster would be just two-thirds of a shilling.

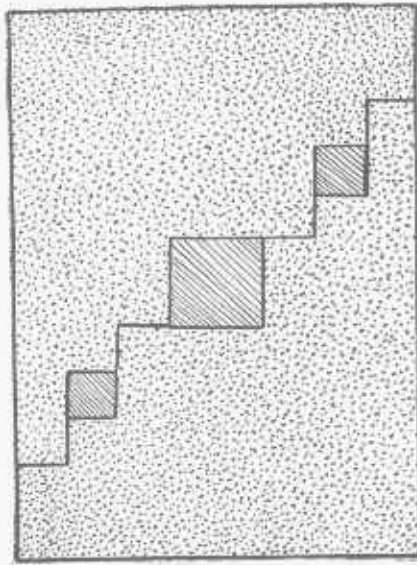

SUBSTITUTION PUZZLE, Sharick.
CHARADE, Pageant.
IN PUZZLELAND shows 31 Triangles. The answer to Solomon's Seal is given in Ancient Greece.

SOLUTION TO ENGINEER'S PUZZLE.

From the engineer's statement, we learn that had he gone 50 miles at full speed, instead of at three-fifths speed, he would have saved 40 minutes. He could have gone 83 1-3 miles at full speed in the same time that it required to go 50 miles at three-fifths speed. Thus he would have saved 33 1-3 miles. If at the same time he saves 40 minutes, then 33 1-3 divided into 40 gives 1 1-5 minutes as his time per mile going at full speed. It is clear that, being reduced to three-fifths of his speed, he would lose four-fifths of a minute every mile, and therefore would have to go 150 miles to lose 2 hours. Thus he went 50 miles at full speed and 150 miles at three-fifths speed, and his entire run was 200 miles.

CHARADE, CARMINE.
Puzzleland Gingerbread cuts:

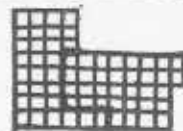

MIXED TEA PUZZLE.

If the Chinese merchant gave his customers a square deal he must have used 30 pounds of the five "bit" tea and 10 pounds of the three "bit" in his forty pounds of mix-

ture, which sold at six "bits" per pound. The cost price being 180 "bits" and the selling price 240 "bits," he gained 33 1-3 per cent.

CHARADE IS HATBOX.
CHARADES Old Maids, Steelyards.
ANSWER TO STAGE PUZZLE.

From the hotel to the wayhouse was 6 miles and from there to Pike-town 3 more, so, if the traveler took the stage to the wayhouse and then walked to Piketown he would beat the stage 15 minutes.

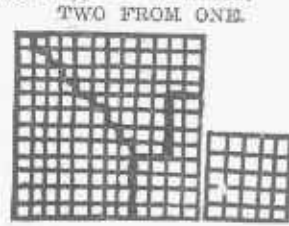

THE MATHEMATICAL MILKMAN started with five and a half gallons of water in Can No. 1, and two and a half gallons of milk in Can No. 2, after the manipulations described he had three gallons of water and one gallon of milk in Can No. 1 and one and a half gallons of milk and two and a half gallons of water in Can No. 2. In the second proposition the first mixture is 40 to one and the second one to 40.

ANSWER TO MILK PUZZLE.

The milkman delivered altogether 87 1/2 quarts of pure milk to his customers. Street No. 1 received 32 quarts; No. 2, 24 quarts; No. 3, 18 quarts, and the last street only 13 quarts and a pint.

PUZZLELAND CHESS BOARDS.

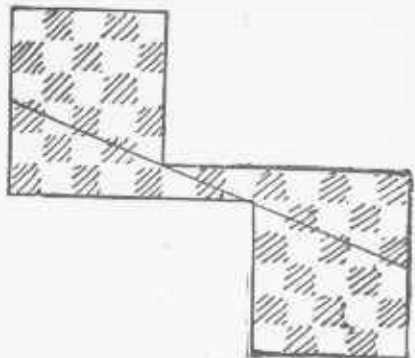
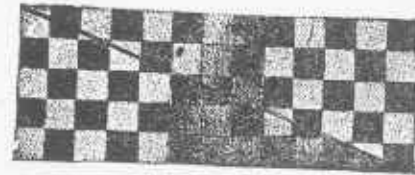

In the Xmas "Zoo" puzzle there are 108 different animals!

In the educated cat puzzle, the words are: Sparkling, sparking, sparing, spring, sprig, prig, pig, pi, I.

The complimentary rebus which the old beau sent to the young lady reads: A chin well rounded is a charming feature.

In that silhouette puzzle of the checker players: The 7th is the French gentleman from Dunkirk, the 11th a Scotchman from Dundee and the 15th is from Dundalk, Ireland.

Here is the way of cutting the checkered pattern in two pieces which will fit together so as to form a square:

Here is the 32 squared checker board on which the regular game may be played:

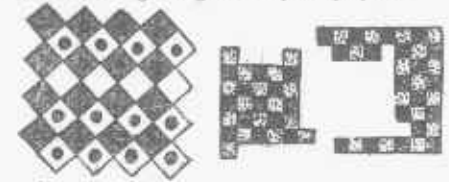

Here is the shortest possible game of checkers:

- | | |
|---------------|-------------------|
| 1. 24 to 20. | 1. 12 to 16. |
| 2. 28 to 24. | 2. 9 to 13. |
| 3. 22 to 19. | 3. 11 to 14. |
| 4. 21 to 17. | 4. 14 to 18. |
| 5. 19 to 15. | 5. 5 to 9 |
| 6. 26 to 22. | 6. 7 to 12. |
| 7. 22 to 19. | 7. 3 to 7. |
| 8. 20 to 26. | 8. 7 to 11. |
| 9. 26 to 21. | 9. 11 to 14. |
| 10. 30 to 26. | 10. 1 to 5. |
| 11. 32 to 28. | 11. 4 to 7. |
| 12. 26 to 22. | 12. 7 to 11 wins. |

Regarding the value of the letters of T. Owen, just number them consecutively T1, O2, W3, E5, and N6: then the T W and O are worth 6. TEN equals ten.

NONE is worth 16, while a TON amounts to 8.

In the Nomination Puzzle Taft jumps Knox, Johnson, LaFollette and Cannon in succession. Gray jumps Fairbanks. Hughes jumps Bryan. Gray jumps Hughes and Taft jumps to the centre.

Here is the answer to the Presidential Puzzle, which is a wonderfully difficult trick:

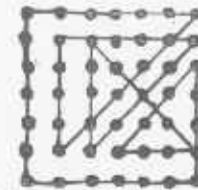

Decapitations.—1. M-abel. 2. M-anna. 3. B-louse. 4. C-hip. 5. H-air. 6. S-hovel. 7. F-rock. 8. C-lock. 9. S-pool. 10. S-kate. 11. M-arch. 12. H-arbor. 13. B-ear. 14. W-heel. 15. H-elm. 16. H-earth. 17. H-one. 18. S-hop. 19. H-owl. 20. M-adder. 21. P-lane. 22. L-ash. 23. M-ark. 24. S-table. 25. S-trap.

A buried proverb says: A rolling stone gathers no moss.

In the HANNAH Puzzle the name may be spelled 14,400 different ways, and in the second puzzle the name can be spelled 4,624 times.

Comic Geography: 1. Wales. 2. Ireland. 3. Chili. 4. Hungary. 5. Poland. 6. Finland. 7. Sicily. 8. Tuscany. 9. Turkey. 10. Greece. 11. Barbary. 12. When he gets to lower Guinea. 13. Because it is Dublin every year. 14. The city of Rheims. 15. Rouen. 16. Berne. 17. Numismatical Puzzle—Calcutta.

In Jungle arithmetic a monkey or crocodile is worth \$2. An elephant is worth one and one-third dollars, so bet cost five and one-third dollars.

In Puzzleland we cut the triangular into four pieces to form a square, as follows:

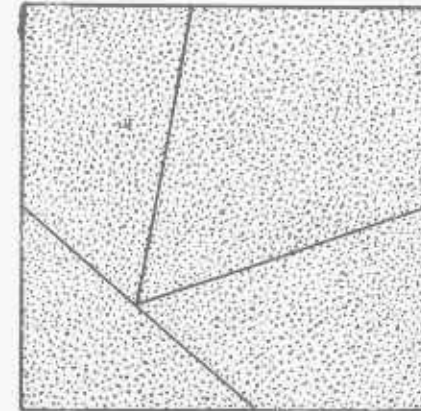
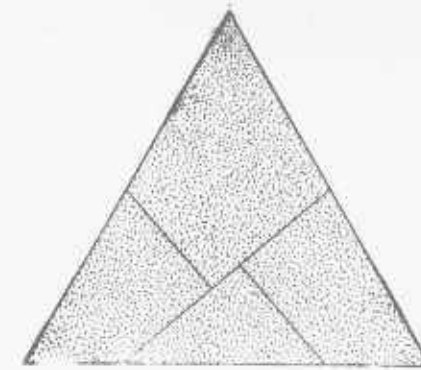

Here is the way to fit the sun spots together:

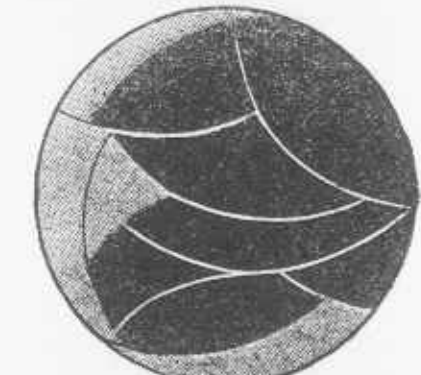

THE BOTANICAL TREE-TICE.

- | | |
|----------------------|--------------------------------|
| 1. The Tea tree. | 23. Hound. |
| 2. Hop vine. | 24. Lime. |
| 3. Beech. | 25. Linden. |
| 4. Bee. | 26. Box. |
| 5. India-rubber. | 27. Dogwood. |
| 6. Bay. | 28. Aspen. |
| 7. Pine. | 29. Rose. |
| 8. Yew (You, not I). | 30. Stoe. |
| 9. Fig. | 31. Plane. |
| 10. Date. | 32. Tulip. |
| 11. Bass. | 33. Spruce. |
| 12. Honeysuckle. | 34. Tiller-tree or eim (beim). |
| 13. Judas. | 35. Sycamore. |
| 14. Peach. | 36. Poplar. |
| 15. Fir. | 37. Southernwood. |
| 16. Bon Chretien. | 38. Ivy. |
| 17. Broom. | 39. Scrub oak. |
| 18. Cypress. | 40. Burning bush. |
| 19. Nightshade. | 41. Hazel. |
| 20. Breadfruit. | 42. Lilac. |
| 21. Orange. | |
| 22. Olive (O-live). | |

GEOGRAPHICAL REBUSES.
Coneord, Madagascar, Marblehead and Salem.

SOLUTION TO TROLLEY PUZZLE

Charley Smallcash and his best girl could trolley three times as fast as they could walk. Therefore, three-quarters of their outing time was spent in walking, and but one-quarter in riding, since they had to walk back. They rode for two hours, going 18 miles, and walked back in six hours, thus consuming their eight hours.

On that "no smoking allowed" sign we read the words: nose, mow, noon, no, one, nod, don, noose, ogle, owed, sled, smell, smoke, smile, soil, sing, singe, skin, singe, sin, snow, saw, sow, snowed, soiled, soil, sill, mow, mill, mile, mire, mire, mood, old, male, me, mad, mew, singled, slow, sole, skill, do, single, sad, sod, ill, glowed, gibe, called, gad, God, gale, know, awe, noll, we, wed, mingled, and many others.

The Perfect Numbers below 10,000 are 6, 28, 496, and 8128.

The precocious little chicken gets one worm out of every thirty-six. Papa keeps twenty-four, the mamma keeps six and gives six to the sixteen chicks; but as that little broiler is equal to three, he represents three-eighths of six, which equals one.

Here is the way the little chicken is divided to make a perfect egg:

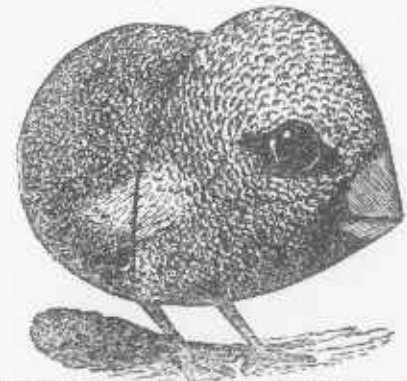

ANSWER TO THE CRAZY CLOCK OF ZURICH.

It calls for a very pretty bit of calculation to prove that if the hands of a clock are started at 6 o'clock, with the hour hand running upon the pinion of the minute hand, as explained in the story of the crazy clock of Zurich, that the dial will show the correct time of the day at 5 minutes, 27 and 3-11th seconds past 7. The problem yields readily to mathematics after one has mastered the principle upon which it is based, but it would be a difficult, if not impossible, task to obtain a correct answer by experimenting with a watch, according to the method which naturally suggests itself.

In regard to that freak bill in the Washington store window, it may be explained that the face of a bill is the promise to pay; the back of a bill—like the curl in a pig's tail—is purely for ornamental purposes. Not unfrequently a person gives a note and afterward gets additional loans until the paper becomes covered with promises to pay. The government has ruled that there are two promises to pay on the bill in question, and has offered to pay both the twenty-dollar and ten-dollar claims.

Some good advice by the Bishop of Oxford says: Watch over your heart to keep out all vice.

Peter the Postman followed the following route:

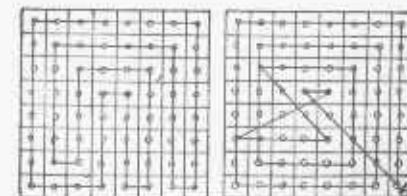

The answer to the puzzle of the Graces and Muses necessitate that each of the three Graces had 144 apples, and every one of the nine Muses 48 flowers. Then let each of the Graces give a dozen apples to every Muse, and let every Muse give 4 flowers, one of each hue, to each of the Graces, and it will be found that every Grace and Muse has three dozen apples and three dozen flowers, and that the flowers being nine of each color, their stores are all just alike.

This feature of the problem is not a catch, but was evidently intended as that part of the mystery which interested Euclid and Archimedes, and which has made the legend so famous.

THE COURIER AND ARMY.

Following the rule for solving puzzles of this kind, which is to multiply the length of the army by its length; then divide by 2 and the square root multiplied by 2 and added to the length of army will give the answer, we find that the courier travels a little over 120 miles.

In the second proposition the courier would have to travel a little over 200 miles.

THE COIN PUZZLE shows the first boy got a 50-cent piece, the next two 2-cent pieces, and the last a 2-cent piece and 2 cents.

ANSWER TO INVESTMENT PUZZLE. One-fourth of Mrs. Smith's money, or one-third of her husband's, or one-seventh of their combined funds would buy that shady grove and babbling brook. The other six-sevenths comes to \$5,000, so that one-seventh, the price of the grove, must have been \$733.23.

ANSWER TO APPLE PUZZLE.

After writing out the various ways in which the apples might have been distributed among the boys, based upon the numbers their sisters had received, it will be found that but one combination will work out the required total of 32 apples.

Ann Jones and her brother Bill received together 4 apples; May Robinson and her brother Jack received 10; Jane Smith and brother Ned were given 6, while Kate Brown and brother Tom got 17.

WILLIAM TELL shot two No. 11s and six No. 13s. The shadow of the net stake where William stands is just half as long as the stake, and as shadows show the same ratio at the same hour, that 35-yard shadow would prove the pole to be 310 feet high.

WHITTINGTON'S CAT went from A to 4—C—I—Y—2 B—6X3 and Z.

It took six seconds to strike six; so the intervals were one and one-fifth seconds; therefore eleven times One and a fifth would be thirteen and one-fifth seconds.

THE LOST STAR was found here:

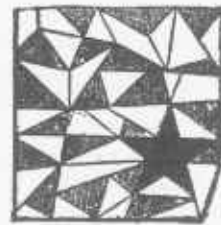

This the way the elephant ran!



COMING TO TOWN Aunt Cynthia tells me that they started out with \$29, and that Reuben paid \$8.50 for his suit and \$6.50 for his hat. She gave \$8.50 for a hat and \$5.50 for a dress. Therefore if Reuben had bought a \$6 hat and she a \$9 hat, her's would have cost half as much more than this, and they would each have spent \$14.50.

THE ODDS AND EVENS puzzle is solved by the man on the fence taking an old-fashioned \$3 gold piece and giving each boy a 25 and a 5 cent piece.

ANSWER TO ANNUITY PUZZLE. The three daughters together received \$35 per annum. The first year, Phoebe, the eldest, was ten years of age, Martha, eight, and Mary Ann two. They received respectively \$17.50, \$14 and \$3.50. Five years later, when the sixth payment was due, their combined ages amounted to thirty-five. Phoebe received \$15, which was one-seventh less than she first received. Martha received \$12, being one dollar less than her first payment, while Mary Ann got 7—or double her first share.

The first whist problem is solved by South leading diamond 3, to which North discards spade ace, after which it is plain sailing. In the second problem South leads heart 7 and North discards diamond ace. South leads spade 5. North takes and leads club 2, etc., etc.

In the Billiard Problem, hit the nearest cushion fourteen inches from the end rail.

The Chess Problem is solved by K. to Kt. 3.

Byron's Enigma was the letter I.

ANSWER TO REAPER'S PROBLEM. In that problem of the three reapers, Ben could have done the work in 12 and 12-2/3 days and Bill would have required 48 days, while if they both worked together they could complete it in 9 and 63-7/8 days. Jake, who could do the job in 9 days, is evidently worth ten shillings per day, so he gets 90 shillings for the five days. Ben, who should have received 40 shillings and 3 shillings and 9 pence less, as that was given to Bill, which establishes his rating, so that it would take him 48 days to earn 90 shillings.

OLD STYLE REBUS: Time and Tide wait for no man.

In that square word puzzle each word can be spelled four ways. In the little girl's magic square she placed a figure 4 in each corner and an 8 in each of the other five, so that 25 can be added ten ways.

ANSWER TO CHARITY PUZZLE. This problem is readily solved by the clever puzzle method of working backwards. If she had 1 cent left after giving 3 cents more than half of the remainder, then it is clear that she must have had 8 cents prior to making her last donation. To the second applicant she gave 2 cents more than half of what she had left—after which she had 3 cents. Therefore, when she met the second beggar she must have had 20 cents. When she encountered the first of her applicants to whom she gave 1 cent more than half of her money—leaving 10 cents—she must have had 22 cents.

SOLUTION TO JACK SPRATT PUZZLE. It is safe to assume that Jack will not trouble the fat so long as there is any lean left, and that Mrs. Spratt will take a like course with reference to the lean. Now, Jack's capacity for lean is 1/2 minus 1/4, or 1/4 of a barrel per week, so that he can eat the lean half of the barrel in two weeks. In the same time Mrs. Spratt will eat 1/12 less 1/4 of 5-12 of a barrel of fat. At the end of five weeks, therefore, there will be left just 1-12 of a barrel of fat, which will suffice Mr. and Mrs. Spratt for five days. Therefore, they will require just forty days to clean up the barrel of half lean and half fat pork.

ANSWER TO TANDEM PUZZLE. Herman contributed three-quarters of the speed for the first third, or one-quarter of the motive power required for the entire journey. Then he gave one-third of the necessary energy for the next quarter, or one-twelfth of the total. Thus for the seven-twelfths of the journey he gave four-twelfths of the energy required for the entire trip. In going the remaining five-twelfths of the way Herman must supply two-fifths of the power or one-sixth of the whole, which, together with his contributions of one-quarter and one-twelfth, makes up one-half.

ANSWER TO PEANUT PUZZLE. There were 1,021 peanuts. The first boy received 225, then a girl 192, then 144 to the next boy and to the little tot 103, which left Aunt Mary 221.

Catch the Christmas turkey in 13 plays by moving them from 38 to 36. In the puzzle take the turkey in the following 24 moves: 8, 62, 14, 12, 8, 9, 16, 18, 10, 11, 62, 29, 31, 23, 25, 22, 45, 30, 4, 5, 69, 60, 2, 3, 7.

Accidental burials conceal the following words: 1. Stag, 2. Sow, (oad), 3. Seal, sea lion, hare, 4. Rhone, Po, cow, ass, rat, 5. Hon, hen, 6. Ass, 7. Shad, 8. Cat, 9. Rat, 10. Hen, 11. Asp, reading, emu, 12. Flee, emu, 13. Ass, moth, fish, 14. Lion, hind, Dan, 15. Ant, ant, 16. Ant, haw, hare, ant, roe, cow, cat, man, tar, Sam, doe, rat, 12, Flee, emu, 13. Ass, moth, fish, 14.

SOLUTION TO AUTOMOBILE PUZZLE. The average speed for the first two hours was 67 1/2 miles per hour, for the last two hours, 52 miles. Difference, 15 1/2 miles in two hours or 7 3/4 miles in one hour. Hence the distance accomplished in the first hour was 71 1/4 miles, in the second 63 1/2, in the third 47 1/2, and in the fourth 42 1/2 miles.

ANSWER TO A NAUTICAL PUZZLE

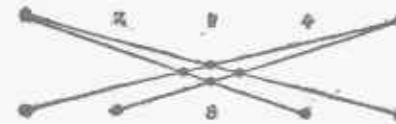

Concerning Guggenheim's two turkeys, which together weighed twenty pounds, it can be proved that the larger bird weighed 16 pounds and the smaller 4 pounds.

The bookworm turns upon the fact that, as the books stand on the shelf, the bookworm has to bore through two covers only, so it requires but two hours.

Thrice beheld the word Nascant and it becomes ascent, scent and cent.

The spinster's age, plus one-half and one-third of her age, plus nine years, equals 70 years, according to her reply to the census taker. Therefore, eleven-sixths of her age is equal to 61 years, and her age must be 33 3-11 years.

In the workshop problem the paper-hanger charged \$200, the painter \$900, plumber \$800, electrician \$300, carpenter \$3,000, and the mason \$2,300.

If there are sixteen players in the lawn tennis contest and the winner must then play with the last year's champion for the new championship, the chances are 31 to 1 against any one of the first players winning from the old champion.

Pat's answer to the volcano riddles was that the man was trying to get to the mouth of the crater.

THE REAL ESTATE PUZZLE.

At the request of many correspondents, I will give a simple, common sense method of getting at the correct answer, which differs from the way others tackled it. According to the puzzle method of working backward, I should analyze it from the last payment by saying that final \$1,000 is 105 per cent of what sum of money? Dividing \$1,000 by 105 shows that \$952.3809 with 5 per cent interest would be the amount of the last payment. Going backward again to the previous payment we ask, what sum must \$1,952.3809 have been 105 per cent of? Divide again by 105, and we get \$1,859.4103. Add the other payment of \$1,000 and we get \$2,723.2479 as the previous amount. Add \$1,000 to make it \$3,723.2479, and another division carries it back to \$3,545.9503. Add \$1,000 once more and another division will give \$4,329.4764 as the balance to bear interest, after the first \$1,000 payment, so \$5,329.4764 was the actual value received for the property, because that sum drawing interest at 5 per cent would just meet the six \$1,000 payments, according to agreement.

ANSWER TO PEDDLER'S PUZZLE.

The old lady who bought some shoe-strings, four times as many papers of pins and eight times as many handkerchiefs, paying as many pennies for each article as she bought number of that article, and expending \$3.24, must have purchased two shoe-strings, eight papers of pins and sixteen handkerchiefs.

Solution of Games of the East.

There are 216 possible variation in the way three dice may fall, of which 42 foot up seven or eleven. Therefore the chances are 42 out of 216 in throwing seven or eleven.

ANSWER TO INSTALMENT PUZZLE.

As the terms of the furniture purchase call for a cash payment of \$5 to begin with, the buyer thus has to decide between an additional \$60 cash payment or fourteen installments of \$5 each, so let us see how long she has the use of the money. She has \$90 for one month, \$55 for the next, \$50 for the next, \$45 for the next, then \$40, \$35, \$30, \$25, \$20, \$15, \$10, and \$5, making in all \$390 for one month, for the use of which she pays \$10, which would be at the rate of \$120 a year, which is paying 30.769+ per cent interest.

The remnant puzzle cut is as follows:



The diamond cuts as follows:



In the race between the hare and the tortoise the length of the track makes no difference. The tortoise has one-eighth start, and has run 4.25 times as fast as the hare up to the time they meet, and as the hare has five-sixths yet to run 5x4.25 equals 21.25 as fast as he went before, but as the question said how much faster, and 20.25 faster is equal to 21.25 as fast, we will say that the answer should be 20.25 plus faster to win. It being clear that 20.25 would only tie the race, he must go a little over to win.

PICTURE SUMS.

Hornet minus Net plus Seal plus Arm plus Clock minus Alarm Clock equals—HORSE.

SIMPLE REPETITIONS.

The following words, when placed in the blank spaces, complete the sentences: Painted, cowslips, hasten, useless, feather and sallying.

A CHAPTER OF ACCIDENTS.

The blank spaces are filled by the following words in their given order: Nat, sat, bat, hat, cat, mat, rat, cat, vat, fat, Pat, I, at.

A FISHING EXCURSION.

The names of the fish are: 1. Star, 3. Carp, 4. Pike, 5. Dog, 6. Cat, 7. Globe, 8. Dab, 9. Torpedo, 10. Sword, 11. Ray, 12. Sole, 13. Cod, 14. Bass, 15. Sturgeon, 16. Gold, 17. Sun, 18. Skate, 19. Perch, 20. Blue.

REMOVING A LETTER.

SCREAM is the word from which the first letter may be removed to produce a country product, again behead it, it leaves a quantity of paper.

SHAKESPEARE REBUS PUZZLE. "WHAT'S IN A NAME?" PERPLEXED PROFESSOR.

If five times six is 33—ten would naturally be 1-3 of what 30 would be, viz: 11.

REBUS PUZZLES.

The Soldier wrote to his Sweetheart: "I cannot bear to leave you" and she replied "All's well that ends well."

DOUBLE BEHEADINGS AND CURTAILMENTS.

1 Stable, 2 Stone, 3 Switch, 4 Swear, 5 Stare, 6 Trace, 7 Trail, 8 Twin, 9 Wheat, 10 About, 11 Brink, 12 Chair, 13 Chill, 14 Snail, 15 Frank, 16 Shears, 17 Price, 18 Plate, 19 Place, 20 Start, 21 Strain, 22 Steam, 23 Spending, 24 Agate, 25 Precach.

CATTLE PUZZLE.

Farmer Jones originally paid \$150 for one cow and \$50 for the other. In selling he made 10% on one and lost 10% on the other, receiving \$210, or a gain of 5% on the transaction.

REBUS PUZZLE.

The Poet said "I think some wonderful thoughts" and the editor replied "You think you think."

GEOGRAPHICAL DROP-LETTER PUZZLES.

1 Nashville-Ashville; 2 Croton-Croon; 3 Abert-A Bet; 4 Tampa-Tama; 5 Pearl-Peal; 7 Tioga-Toga; 8 Virgil-Vigil; 9 Amboy-A Boy; 10 Bath-Bat; (and) Potter and Otter; 11 Burns-Urns; 12 Hume-Hum; 13 Rome-Roe; (and) Fine-Fin; 14 Wheeling-Heeling; 15 Orange-Range; 16 Maine-Mine; 17 Cuba-Cub; 18 Ilion-Lion; 19 France-Franc; 20 Olean-Lean; 21 Spain-Pain; 22 Salem-Sale; 23 and 24 Volga-Olga; 25 Pike-Pie; 26 Islip-Slip; 27 Helena-Helen; 28 Nile-Nil; 29 Boone-Bone; 30 Ravena-Raven; 31 Cato-Cat; 32 Dover-Dove; 33 Texas-Teas; 34 Indiana-Indian; 35 Florida-Florid.

POLITICAL PUZZLE.

The political boss spent 1-6 of his age, plus 1-12 of his age plus 1-7 of his age plus 3 years before his son was born. Four years ago the son was 1-2 of his father's age, so today he must be 1-2 of his dad's age plus 4 years. Calling the father's age X, we have 1-6, 1-12 and 1-7 of X plus 5 years plus the years since the son's birth, which is represented by the son's age, 1-2 of X plus 4, total 75-84 of X plus 9 years as equal to the father's present age, X. This equation gives the value of X, the "boss's" age as 84 years, which is the correct answer.

PUZZLE SUMS.

Crow plus Heel minus Wheel plus Cod plus Bee plus file minus Beef equals—Crocodile.

RHYMING BIRDS.

The following words complete the rhyming lines: Eagle, Raven, Owl, Bobolink and Robin.

THE SEA SERPENT PUZZLE.

There were three totally blind serpents and three with both eyes sound.

SHAKESPEARE'S REBUS PUZZLE.

"All's Well that Ends Well."

CAT AND DOG PUZZLE.

In the Cat and Dog Puzzle, she goes "there and back" a distance of 162 feet in 54 jumps, but as the dog goes 5 feet at a bound, he has to make 17 leaps each way, which is the same as losing 8 feet. Dividing the cat's 54 jumps by 8 and multiplying by 5, shows that the dog would be beaten by 1 foot 3 inches.

PICTURE SUMS.

Tap plus Bee plus Fir minus Beef equals TAPIR.

A DOZEN LEGAL SEPARATIONS.

1 Pump-kin; 2 Rat-her; 3 Extortion-ate; 4 Per-verse; 5 End-ear; 6 Rein-state; 7 Pur-chase; 8 Aver-age; 9 Bar-gain; 10 Car-mine; 11 Hum-drum; 12 Cape-ring; 13 Bug-bear.

A BURIED PROVERB.

'Tis a Long Lane that has no turning."

A PUZZLE TRAGEDY OF THE HIGH SEAS.

NINEVEH — PARIS — PALMYRA — SPARTA — THEBES — NAPLES — ANDOVER — DOVER—ATHENS — VERONA and ROME.

DOUBLE DECAPITATIONS.

Trills, Rills, Ills; Trout, rout, Out; Skill, Kill, Ill; Spray, Pray, Ray; Flit, Lit, It.

SHAKESPEARE'S REBUS PUZZLE.

"TO BE OR NOT TO BE."

SKATER'S PUZZLE.

Jennie must have skated a mile in 4 minutes, to Maud's 10, being $2\frac{1}{2}$ times as quick, and allowing her to win by six minutes.

PUZZLE SUM.

Shawl minus awl plus Ark equals Shark.

SIMPLE REPETITIONS.

The following words placed in the blank spaces complete the sense of the sentences in their given order:—1 Beat-en-be at ten; 2-Notable-not able; 3-Of-ten-of ten; 4-Tomato-To ma; 5-Parents-pa-rents; 6-Profit-able, Profitable; 7-Alter-native-alternative; 8-Hand-led-handled; 9-Abet-A-bet; 10-About-A bout; 11-Useless-Use less; 12-Beg one-Begone.

DOUBLE DECAPITATIONS.

1 Spear, 2 Blink, 3 Scold, 4 Wheel, 5 Shark, 6 Snail, 7 Still, 8 Stone.

CONDUCTOR'S PUZZLE.

According to the suburbanite's reply to the conductor, the son, daughter, wife and husband are collectively 81 times the age of the daughter, and since their combined ages equal the grandmother's 81 years, the baby is one and the boy five years of age.

FIND YOUR PORTRAIT IN THE MIRROR.

The mirror held in a slanting position away from the gas reveals the portrait of a donkey.

THE PISTOL MATCH.

The score of 96 containing three "doublets" was made by scoring twice in the 25 ring, twice in the 20 and twice in the 3.

The grey cow's soliloquy phonetically read may be translated as follows:

"I browse all day through lone wood or vale waiting for the sun's low rays to mark the hour the maid with her pail on her head leads the herd home by the gate."

KITTIE'S PUZZLE

Kittie had 7c and her brother Harry 5c.

